

DOLBY B, C, AND S NOISE REDUCTION SYSTEMS:

Making Cassettes Sound Better

In this age of digital audio it should come as little surprise to anyone that cassette tapes do not have the same basic fidelity as compact discs (CD). The dynamic range available, between the noise floor and the highest signal levels that can be recorded without distortion, is a fundamental limitation of magnetic audio tape itself. Even if you make cassette recordings from noise-free sources like CD, when the music stops between songs, tape hiss intrudes. What we call hiss is the noise created by the magnetic particles on the tape, and it can obscure the quality of the music and become annoying. Dolby noise reduction has made it possible to protect the music from tape noise, and helped make cassette the most popular audio product ever devised. Here's how it works.

TABLE OF CONTENTS

[Common To All Three Systems](#)
[Dolby B-Type Noise Reduction](#)
[Dolby C-Type Noise Reduction](#)
[Dolby S-Type Noise Reduction](#)
[Dolby Noise Reduction Systems Technology Comparison Chart](#)

DOLBY B, C, AND S NOISE REDUCTION SYSTEMS:

Making Cassettes Sound Better

COMMON TO ALL THREE SYSTEMS

Dolby noise reduction is a two-step process:

Step 1.

When music is being recorded, it is **encoded** just before reaching the tape. The purpose of encoding is to raise the level of soft, high-frequency passages so they become louder than the tape's noise. During the trip through the Dolby encoder, **loud** passages (that hide tape hiss) are not altered. **Soft, high-frequency** passages (that tape hiss affects) are made louder than normal as they are recorded on the tape.

Step 2.

When playing back the tape, the sound is **decoded** by a precise mirror-image process of the encoding in Step 1. The loud sounds are left unaltered, while the soft, high-frequency sounds are lowered back down

to their original levels. (You may have noticed that Dolby B tapes sound brighter when played without any Noise Reduction decoding. Now you know why! You are hearing the encoded sound, not the original.

NOISE REDUCTION TAKES PLACE DURING DECODING. Tape Hiss is added to the recording during the recording process. In step 1 we learned that the Dolby **encoder** boosted (made louder) the soft, high-frequency passages before the signal reached the tape and before tape hiss was mixed in.

During Step 2, the Dolby **decoder** doesn't "know," as it scans the signal coming off the tape, that tape noise has been added to the music—it just goes about the business of reducing the encoded sounds to their original levels, with the noise automatically getting the same treatment. The result? Completely restored musical balance but with less hiss in the reproduced sound (see figure 1).

Recording with Dolby noise reduction.

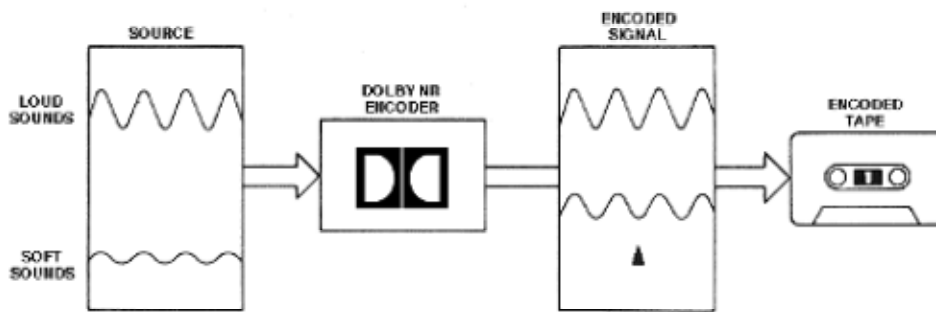

Playing back with Dolby noise reduction.

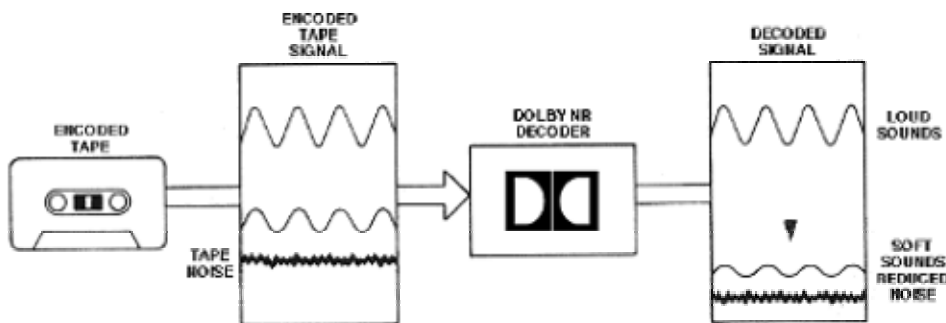

Figure 1. How Dolby noise reduction works.

Such encode-decode systems are generally called "componders." They compress the range between loud and soft when recording and expand the range back again on playback, and reduce noise in the process. While Dolby B-type, C-type, and S-type noise reduction systems all operate as companders, there are many differences in the amount of noise reduction, the methods used to achieve it, and the level of technology used in each.

DOLBY B, C, AND S NOISE REDUCTION SYSTEMS:

Making Cassettes Sound Better

DOLBY B-TYPE NOISE REDUCTION

Dolby B-type noise reduction was developed in 1968 to address the hiss of slow-speed consumer tape-recording formats, such as 3-3/4 inches per second open-reel, compact cassette, and, later, the stereo linear tracks on VHS video cassette tape.

Magnetic tape can only hold so much signal. If you put too much signal onto the tape, it will overload or "saturate." The louder the signal that is being recorded, the closer the tape becomes to being "saturated." If you were recording loud (high level) signals and at the same time you boosted them significantly for the purpose of noise reduction, the tape would over-load and the recording would become distorted and harsh sounding. Making matters worse for today's high-tech music styles, the bass and treble extremes of the audible spectrum of magnetic tape have even less capacity than the midrange.

"If it isn't broke, don't fix it"

It is very important that the use of noise reduction not take away from the ability to record loud sounds by unnecessarily boosting them. Loud sounds already hide noise on their own, so any increase would only mean the overall recording level would have to be turned down to prevent distortion. All Dolby Noise Reduction systems apply the principle of "least treatment" in their design. This means that the loud signals are not processed, so there is no chance of causing tape overload when Noise Reduction is being used.

Least treatment essentially means that if there is no benefit to be gained by changing the audio signal, then **don't change it**. This is the reason that the compression-expansion process is only used on softer (low level) signals (see Figure 2). For example, suppose you want to record a solo, loud rap on a bass drum. The main part of the drum's sound is at low frequencies and may already approach the tape's overload point. Even so, the drum is not able to hide the hiss noise in the treble range. The Dolby B-type noise reduction encoder does not provide a boost to the drum signal, so the tape will not over-load (saturate). However, it **does** provide a full boost over the rest of the frequency spectrum. During playback through a Dolby B-type decoder, there is effective noise reduction and no tape over-loading. Dolby B-type Noise Reduction does this by using a SINGLE, SLIDING COMPRESSION-EXPANSION BAND of frequencies. A sliding band is basically a filter that can shift its frequency breakpoint up and down. In B-type noise reduction, the frequency where the noise reduction action just begins can change from about 300 Hz all the way out to 20,000 Hz.

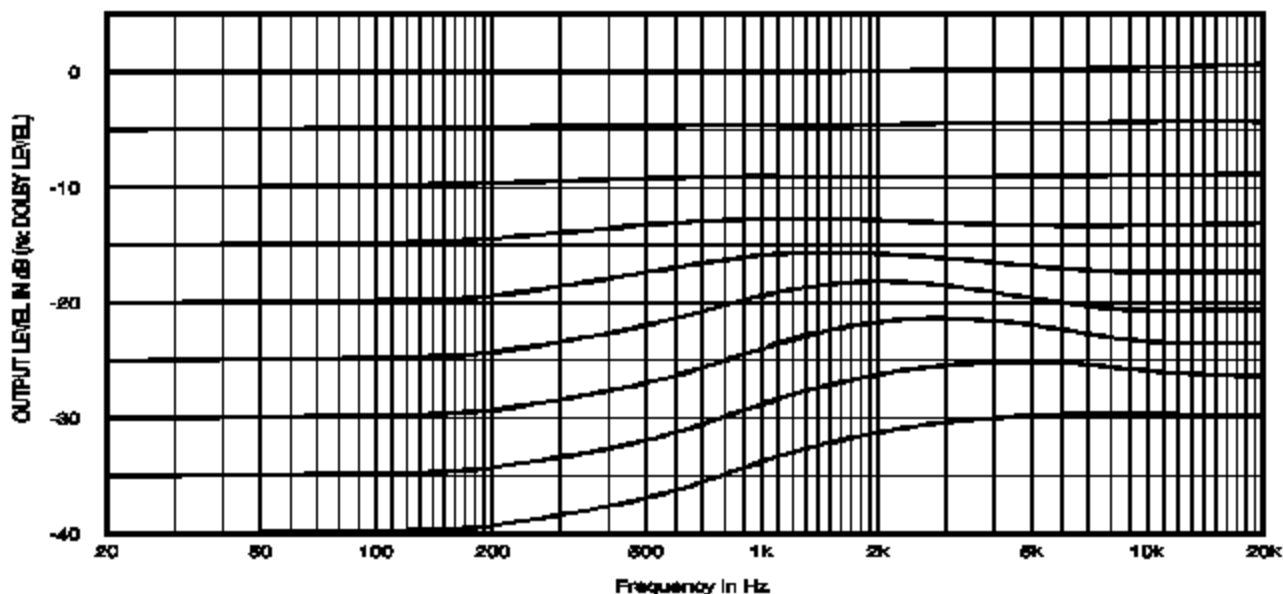

Figure 2. Record processor characteristics.

When the audio signal is very low or contains no treble frequencies, the band slides to the lowest frequency point (all the way to the left in Figure 3), giving a maximum of 10 dB noise reduction above 4,000 Hz. As the band slides to higher frequencies, less and less of the spectrum is covered, so there is less effect. The band will not slide up, however, until the sounds being recorded are loud enough to hide the noise on their own. By moving the sliding band quickly enough to follow the music being played, the full effect of the noise reduction is maintained. In Figure 3, the sliding band slides up (in frequency) out of the way of the loud bass drum signal (the "dominant frequency"), and keeps the noise reduction working at higher frequencies, where tape hiss would otherwise be audible.

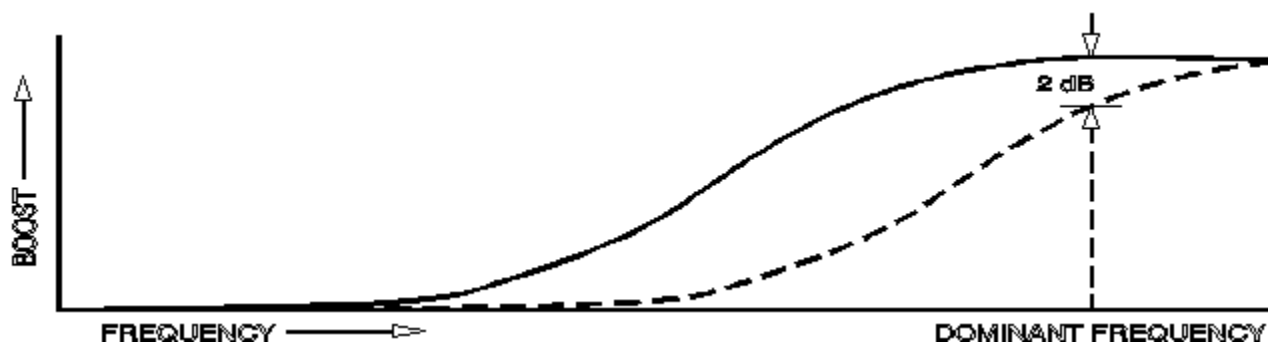

Figure 3. Effects of dominant signals within the NR band also vary with the system. To effect a given decrease in gain (2 dB shown) at the dominant frequency, the NR band of a sliding-band system slides up, reducing NR at frequencies below the signal.

In all Dolby Noise Reduction systems, the key to the operation is in the positioning of the sliding bands. In order for the final decoded sound to be faithfully restored, the bands in the decoder must track the positions of the bands in the encoder as closely as possible. The recorded audio signal tells the decoder how to operate. If, for some reason, the level or the frequency response of the encoded signal is changed before it reaches the decoder, mistracking of the sliding bands will occur. How audible this becomes has to do with several factors, including the nature of the music, the listening conditions, and the sensitivity of the listener. By limiting its overall range to 10 dB, B-type Noise Reduction is not very susceptible to

audible mistracking. Still, it is advisable to make sure that the tape formulations used with any recorder are compatible with its design, and that the proper settings are used for bias and record calibrations.

TECHNICALLY SPEAKING

In Figure 4 you can see that the compression expansion process is only operating at middle-level signals (not real loud, or real soft passages). At high signal levels (loud passages), there is no dynamic action and the system acts as a unity-gain amplifier. At low signal levels (soft passages) the system acts only as a fixed-gain amplifier. By restricting the system's compression-expansion action to only the middle-level signals, distortion caused by overshoots is minimized. See Figure 5 for a Block Diagram of Dolby B-type Noise Reduction.

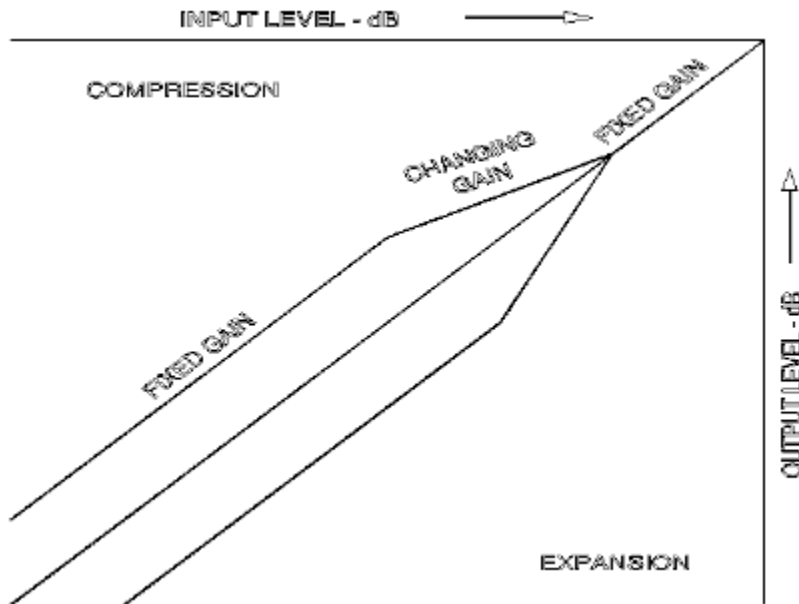

Figure 4. Dolby B-type bilinear compression and expansion.



Figure 5. B-type noise reduction system-block diagram.

Dolby B-type noise reduction is now the standard in tens of millions of cassette decks, mini-component systems, boom boxes, personal portables, and car stereo components; it provides 10 dB of noise reduction above about 4,000 Hz.

DOLBY B, C, AND S NOISE REDUCTION SYSTEMS:

Making Cassettes Sound Better

DOLBY C-TYPE NOISE REDUCTION

Introduced to the public in 1980, Dolby C-type provides 20 dB of noise reduction above about 1,000 Hz, fully doubling the amount given by B-type. Additional features were incorporated to deal specifically with the difficulties of recording on slow-speed consumer tape formats.

Increased Noise-Reduction Bandwidth

Cassette tape gives a noise spectrum, without Noise Reduction, which appears to be concentrated in the high frequencies. That's why we refer to hiss rather than roar or rumble. Noise is less noticeable when no one part of the audible spectrum is apparently dominant. At the other extreme, noise with a distinct pitch, due to dominant energy in a narrow region of the spectrum, is especially irritating. Listening to tape hiss with B-type noise reduction reveals that the noise is not only lower in level, but that it sounds more evenly balanced across the frequency spectrum, because the concentrated noise at high frequencies has been reduced. However, as you continue to reduce high frequency noise, as in Dolby C-type, obviously the middle and low-frequency components of the tape noise become relatively more significant. If you were to reduce the high frequency noise by twice as much in the region of the spectrum where B-type noise reduction operates, middle frequencies would dominate in the resultant noise, and you might well describe it as a roar rather than a hiss. As you apply more and more high-frequency noise reduction to cassette tape, you need to extend the region of that noise reduction lower and lower in frequency so that no one area of the spectrum becomes (apparently) dominant.

Referring to Figure 6, you see that the Dolby B-type system begins to take effect in the 300-Hz region and increases its action until a maximum of 10 dB of noise reduction is achieved in the 4,000 Hz and above region. What you hear is an overall reduction of noise. The remaining noise is not noticeable because it appears to be spread evenly over the frequency range.

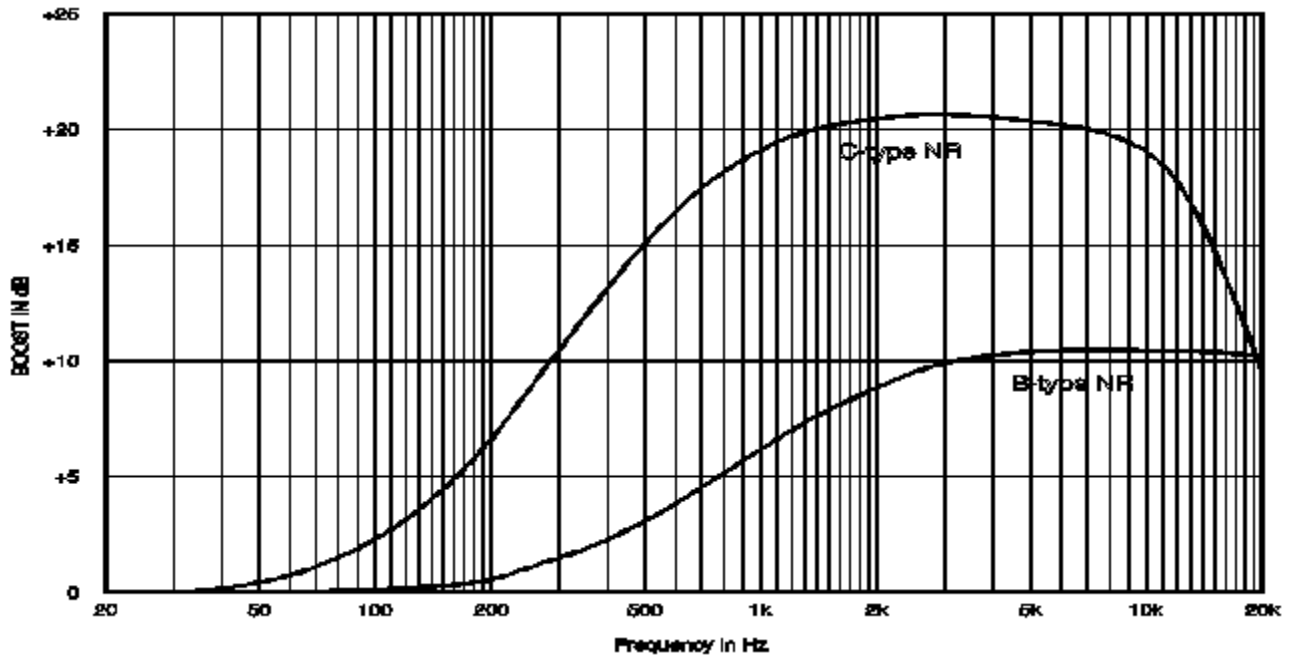

Figure 6. Low-level encoding characteristics of Dolby B and Dolby C. More boost is provided by Dolby C, and it extends about two octaves lower. The playback decoding, and thus the maximum noise reduction effect, is the reciprocal of the curves shown.

Again, referring to Figure 6, you see that Dolby C-type noise reduction begins to take effect in the 100 Hz region and provides about 15 dB of noise reduction around 400 Hz and 20 dB in the critical 2,000 to 10,000 Hz hiss area. By starting two octaves lower than Dolby B-type, what little noise that is left again appears to be spread evenly over the frequency range and is not noticeable.

Dual-Level Processing

Covering a full 20 dB of processing range with a single sliding filter leads to problems such as excess encoder gain during musical transients (overshoots), and overstressed manufacturing tolerances. These problems were solved by using TWO SLIDING COMPRESSION-EXPANSION BANDS in a special way: both bands cover the same frequency range but are sensitive to signals at different levels. One, of the two sliding compression-expansion bands, is sensitive to signals at almost the same level as a Dolby B-type processor, while the other sliding compression-expansion band is sensitive to signals at a lower level. As one filter reaches the end of its sliding range, the other one gradually takes over. Each one provides 10 dB of compansion. They are connected in series, so their effects add together to provide 20 dB of compression-expansion and so 20 dB of noise reduction (see Figure 7).

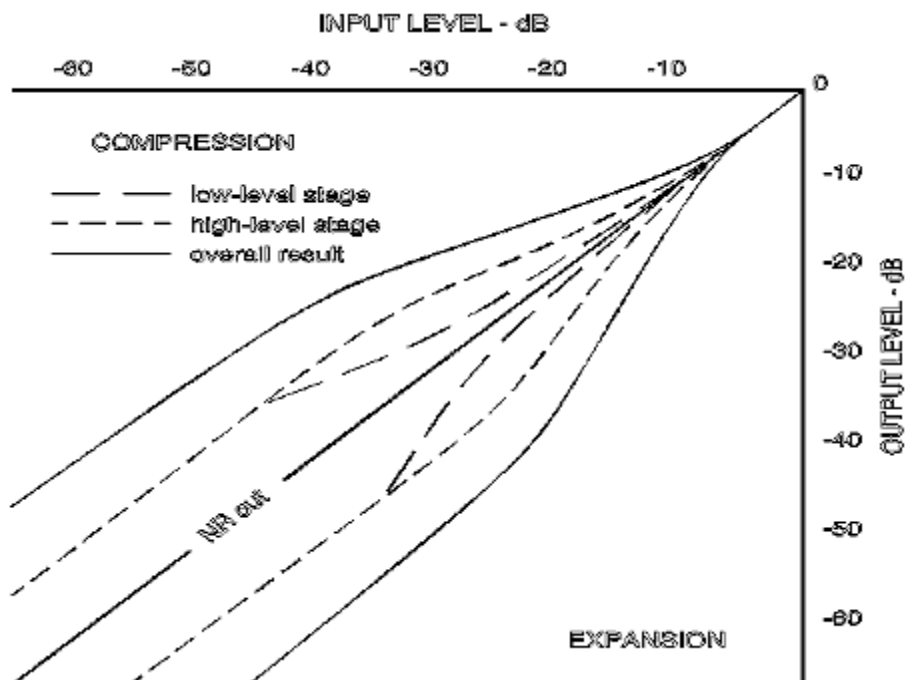
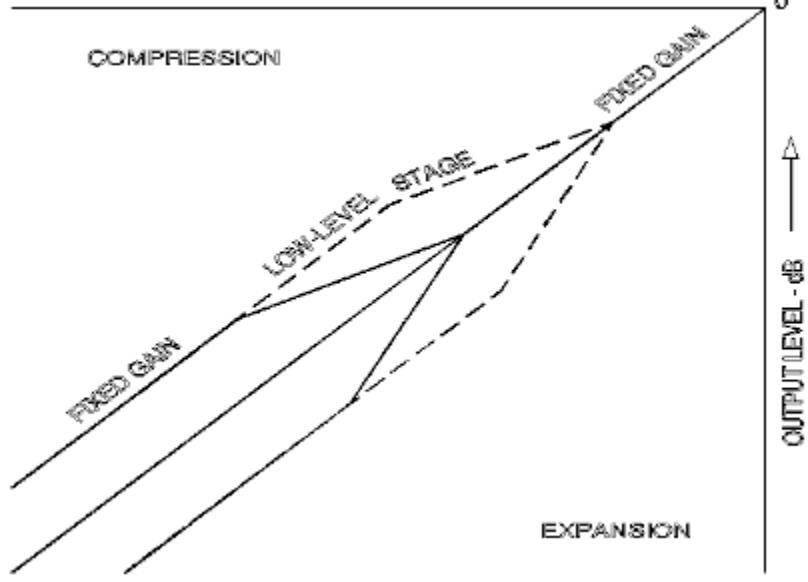
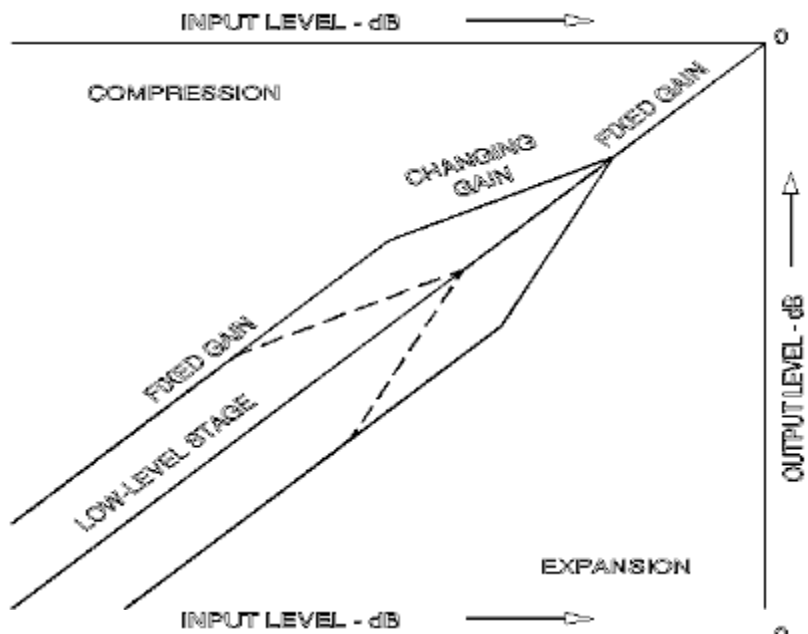

Figure 7. Dolby C transfer characteristics, showing how the effects of the two stages combine to produce 20 dB of compression.

TECHNICALLY SPEAKING

Figure 8 shows how the dual-level processors work together. You can see that the compression-expansion process is only operating at middle-level signals (not loud or soft passages). At high signal levels (loud passages), there is no dynamic action and the system acts as a unity-gain amplifier. At low signal levels (soft passages) the system acts only as a fixed-gain amplifier. By restricting the system's compression-expansion action to only the middle-level signals, distortion caused by overshoots is minimized.



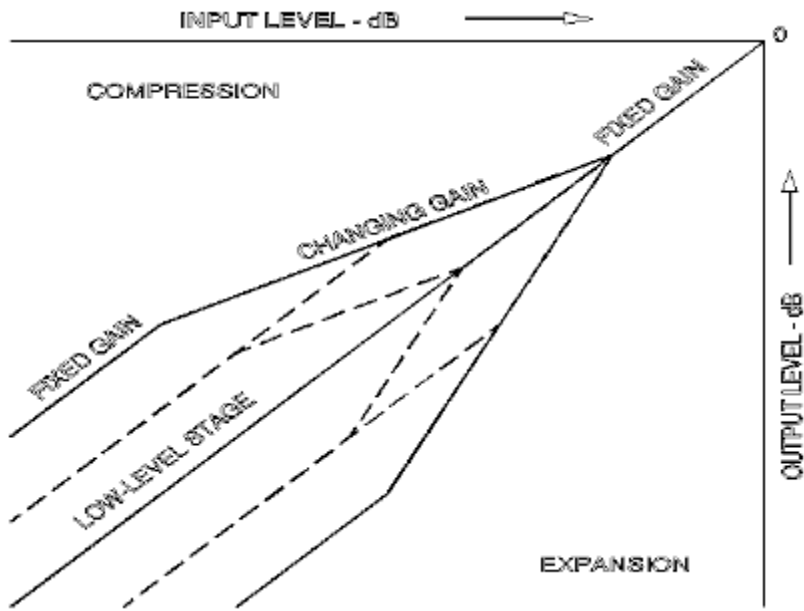

Figure 8. The Dolby S-type NR system prevents multiplication of compression ratios by staggering the signal levels at which gain changes occur, as shown for the high-level stage (A) and low-level stage (B). However, at low levels, the boost of the two stages add (C) to provide more noise reduction.

Spectral Skewing and Anti saturation

While B-type noise reduction was first developed for use in an open-reel format, C-type noise reduction was able to focus on the cassette's limitations more directly. It was evident that modern music was pushing the levels of high frequencies as time progressed. Additionally, in noise-reduction systems the encoded signal must be precisely decoded. But the decoder does its work **AFTER** the encoded signal has been recorded on the tape. If the tape recorder and the tape don't work together well, or differ significantly between Record and Playback performance, they can change the encoded signal before the Dolby decoder sees it. This can cause mistracking and possible side effects that you can hear. The larger the amount of noise reduction that you try to do, the easier it is to hear these side effects. With Dolby C-type, with 20 dB of noise reduction, two additional developments were added to prevent mistracking, particularly at higher frequencies, and to improve high frequency quality:

Spectral Skewing: In the very first step of the encoding mode, just before the signal is boosted, the high frequencies (above 10,000 Hz) are precisely lowered in volume (filtered). This high frequency roll-off causes the encoder to ignore what's happening above 10,000 Hz. The purpose of this "spectral skewing" process is two-fold. First, the noise reduction circuits will be much less sensitive to errors in record-play frequency response because they can ignore what's happening above 10,000 Hz. Second, the levels of high frequencies actually being recorded on the tape are reduced significantly between 10,000 and 20,000 Hz, making it much easier for the tape to accurately handle these signals. A mirror image increase in volume of the frequencies above 10,000 Hz is provided (to restore a flat frequency response) right after the signal is lowered in the decode mode. (See figure 9 for location within Block Diagram of Dolby C-type) Because the filter shape is very selective, the fact that it is boosting gain (and noise) during playback does not degrade the quality of the noise reduction at all.





Figure 9. The Dolby C-type noise reduction block diagram.

Anti saturation networks reduce the high-frequency losses and distortion caused by tape saturation, further reducing decoder mistracking. They also increase recording headroom. Anti saturation networks start their action at a lower frequency (about 1,500 Hz) than spectral skewing, so they are only used on loud (high level) levels. Otherwise, they might interfere with the noise reduction process. Just like spectral skewing, during the encode mode, just before the signal is boosted, the affected frequencies are lowered in volume. Also, just like spectral skewing, a mirror image increase in volume of the affected frequencies is provided in the decoder to maintain a flat frequency response.

The encoder curves shown in Figure 10 not only show the overall characteristic of Dolby C-type noise reduction, but also show the effects of spectral skewing and anti saturation networks. The roll-off above 10,000 Hz at all levels is the result of spectral skewing; the gentler downward slope beginning at about 1,500 Hz on the higher-level curves is the result of anti saturation.

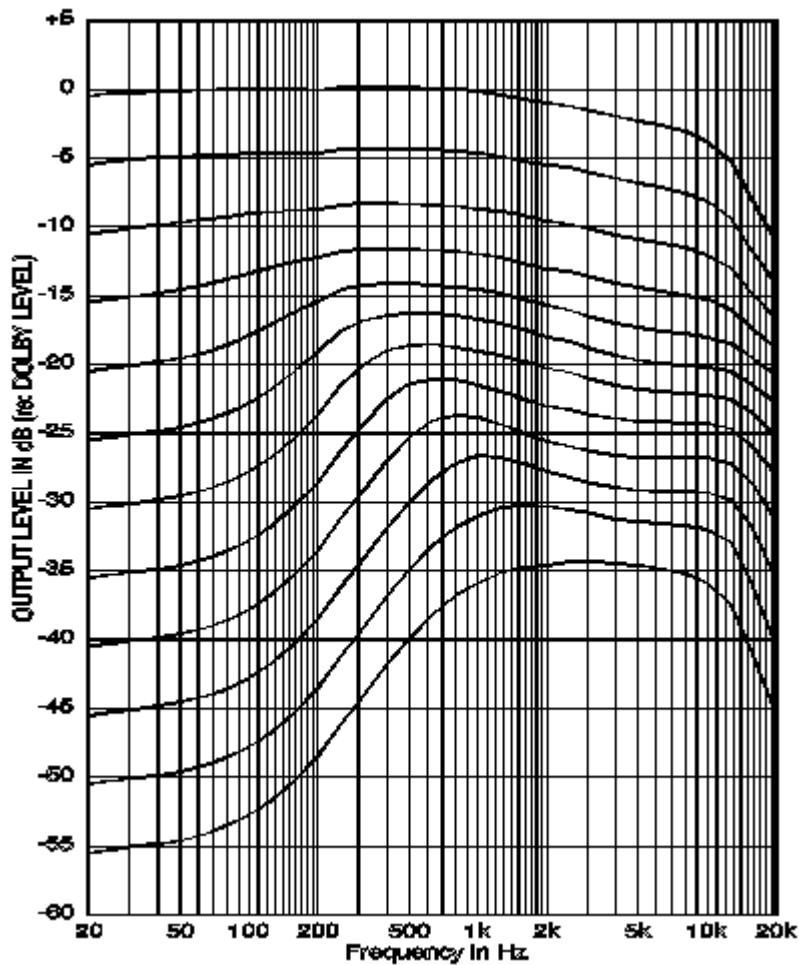

Figure 10. Dolby C encode characteristics, showing the effects of spectral skewing and anti-saturation (see text).

The development of the acclaimed Dolby SR Spectral Recording process for professional audio applications brought forth a number of powerful new audio processing techniques. Experiments with these clearly demonstrated the potential benefits to the cassette format. After several years of intense design work on the first integrated circuits, the first Dolby S-type cassette decks were introduced to the public in late 1990.

DOLBY B, C, AND S NOISE REDUCTION SYSTEMS:

Making Cassettes Sound Better

DOLBY S-TYPE NOISE REDUCTION

Dolby S-type noise reduction was the culmination of over 20 years experience in the design of noise reduction systems and the licensing of audio cassette decks. Just as Dolby's noise reduction technology made dramatic advances in two decades, so did the capability to manufacture quality audio cassette decks. The drive mechanisms, motors, tape heads, tape formulations and electronics had all progressed significantly over that time. Dolby took the position that if S-type were to be its premiere noise reduction technology, there should be specifications on the rest of the cassette deck to ensure the overall result would be consistent with that level of performance.

Dolby Laboratories requires that cassette decks that are to include Dolby S-type Noise Reduction meet new, higher performance standards, including:

EXTENDED HIGH FREQUENCY RESPONSE
TIGHTER OVERALL RESPONSE TOLERANCES
A NEW STANDARD ENSURING HEAD-HEIGHT ACCURACY
INCREASED OVERLOAD MARGIN IN THE DECK'S ELECTRONICS
REDUCED WOW AND FLUTTER
A NEW HEAD AZIMUTH ALIGNMENT STANDARD

Cassette decks meeting these new Dolby S-type standards will provide improved cassette performance, and tapes recorded on one machine—including prerecorded cassettes—will play back with unprecedented accuracy on any other machine.

Dolby Laboratories tests and approves prototype samples of all cassette decks that include Dolby Noise Reduction systems to insure that these standards are met in the design, before the product may be manufactured. In general, if a cassette deck has Dolby S-type Noise Reduction, it is the consumer's assurance that it was designed to meet a higher standard of performance, and will produce better recordings, even if Dolby S-type Noise Reduction is not used.

Action Substitution

Dolby S-type Noise Reduction applies the principle of *least treatment* in some powerful new ways. Even though it provides even more effect than ever before (up to 24 dB), the Dolby S-type Noise Reduction processor devotes much of its energy to *not* processing the audio signal. That's right, more effect with less visible effort.

This economy of movement is achieved through the use of a new kind of filter design combined with a sophisticated method of controlling filters' actions and interactions. The goal of this exercise is to keep the encoded signal as steady as possible. If the encoded signal does not sound like it is changing drastically, and exhibits no "pumping" types of modulation sounds, then that signal is inherently easier to decode flawlessly.

Like Dolby C-type, Dolby S-type uses TWO HIGH FREQUENCY SLIDING COMPRESSION-EXPANSION BANDS. But, in addition, **EACH SLIDING COMPRESSION-EXPANSION BAND IS COUPLED WITH A SEPARATE HIGH FREQUENCY FIXED BAND PROCESSOR**. By using these coupled processors, called Action Substitution, Dolby S-type noise reduction is able to provide 24 dB of HIGH FREQUENCY noise reduction.

When loud (high level) signals are allowed to effect soft (low level) signals, the ear hears a "pumping" sound. The coupling of a sliding band processor with a fixed band processor (Action Substitution) reduces to a minimum the effect of loud signals on soft ones, eliminating "pumping."

TECHNICALLY SPEAKING

Figure 11a shows the operation of a **Sliding** Compression-Expansion Band in the presence of a single "dominant frequency." Figure 11b shows the operation of a **Fixed** Compression-Expansion Band in the presence of the same single "dominant frequency." Figure 11c shows the benefit of a combination (Action Substitution) approach: the action of the fixed band works on the frequencies **below** the "dominant frequency," while the action of the sliding band works on the frequencies **above** the "dominant frequency." With **Action Substitution**, the soft (low-level) signals are more constantly boosted, and noise reduction is more effective.

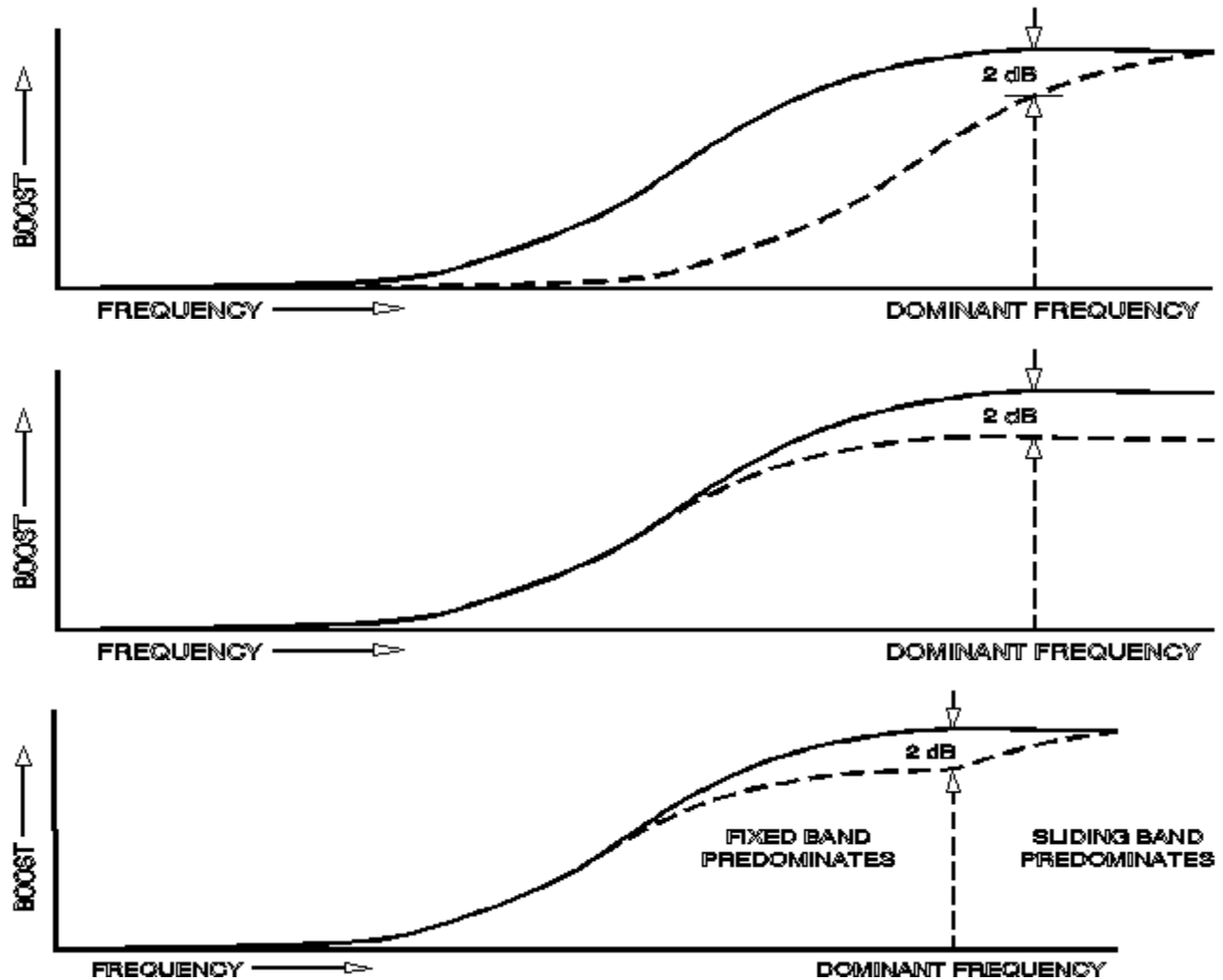

Figure 11. Effects of dominant signals within the NR band also vary with the system. To effect a given

decrease in gain (2 dB shown) at the dominant frequency, the NR band of a sliding-band system (B), boost (and thus NR) is reduced throughout the band by the amount of gain decrease required at the dominant frequency. Combining fixed and sliding bands (the "action substitution" system used in Dolby S-type NR) confines the gain decrease more closely to the dominant frequency, resulting in less loss of NR (C).

Action Substitution has an additional benefit. With an encode-decode noise reduction system like Dolby's, changes in level occurring after the signal has been encoded can cause the playback decoder to mistrack, that is, it may not act as a precise mirror-image of the encoder. Using only a sliding band system, a small level-change, introduced by the tape recorder, after the encoder, at the "dominant frequency," can cause **decoder mistracking at lower** frequencies large enough to be heard. Dolby S-type Noise Reduction, with Action Substitution, uses the action of the fixed band, working on the frequencies below the "dominant frequency," to eliminate this problem.

Modulation Control

Dolby S-type uses a special technique, called Modulation Control, which is applied to both the sliding and the fixed bands. It reduces the tendency of a sliding band to move further away from high-level (loud) signals than is necessary (See Figure 12A). It also reduces a fixed band's tendency to react to high-level (loud) signals outside, but close to, the band (See Figure 12B). Like Action Substitution, **Modulation Control** helps to keep **ALL** low-level (soft) signals more constantly boosted, and noise reduction more effective.

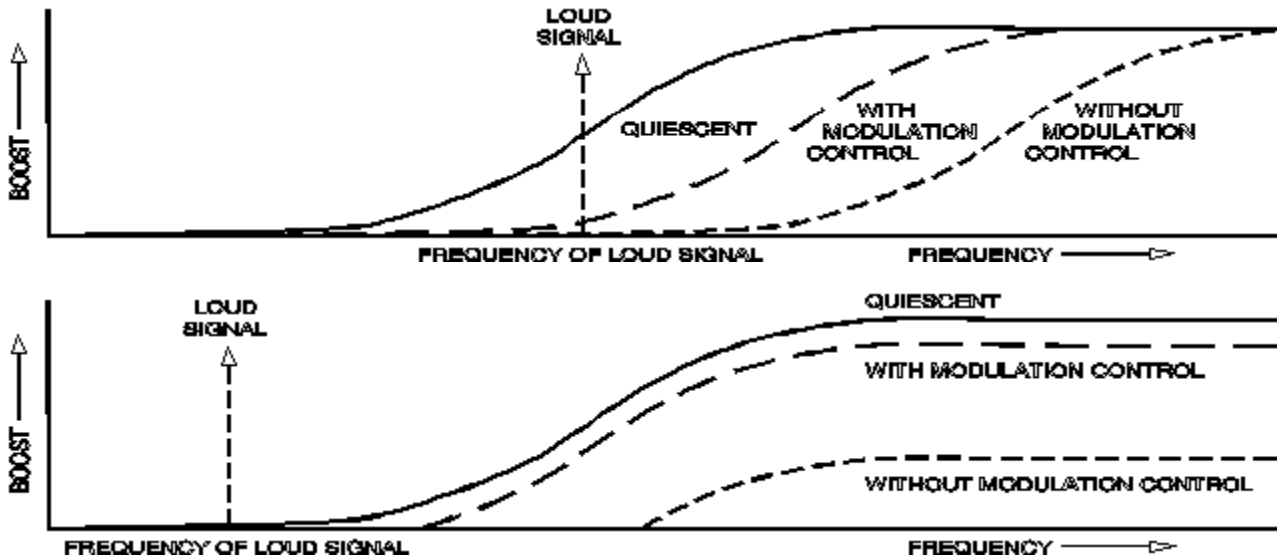

Figure 12. Modulation control reduces the tendency of a sliding band to move further away from a high-level signal than necessary (A) and of a fixed-band system to reduce gain in the presence of a high-level signal at a nearby frequency (B).

Low Frequency Noise Reduction

In addition to the HIGH FREQUENCY noise reduction discussed above, Dolby S-type Noise Reduction also has a LOW FREQUENCY FIXED BAND PROCESSOR, which provides 10 dB of low frequency noise reduction below 200 Hz (in addition to the 24 dB in the high frequency stages). Because of: (1) the nature of cassette noise, (2) the ear's reduced ability to hear low frequency noise, and (3) the low frequency that the high frequency bands start at, the low-frequency fixed band processor needs to work only below 200 Hz and does not have to exceed 10 dB in action. This amount of low frequency noise reduction provides the smooth noise spectrum, with no one area dominating, that is desired. An additional

benefit of this low frequency band processor is that it keeps the music balanced when listening to a Dolby S-type encoded tape on a machine using Dolby B-type noise reduction.

Spectral Skewing

Like Dolby C-type above, Dolby S-type has Spectral Skewing too; but in addition to the rolled off **high end** used in Dolby C-type, Dolby S-type has added networks in the **encoder** which precisely roll off (lower the volume of) the extreme **low end**. Of course, mirror-image networks in the **decoder** restore flat response. The purpose of Spectral Skewing is to reduce decoder mistracking due to tape recorder generated errors. Some of these recorder generated errors are caused:

At low frequencies, by head bumps.

At high frequencies, by variations among tape formulations, even within the same tape type.

At high frequencies, by head-azimuth variations between the machine on which a tape is recorded and those on which it is played back.

While Spectral Skewing causes some loss of noise reduction effect at the frequency extremes, the ear does not sense noise at the extremes of the frequency range well, so the benefits of Spectral Skewing far outweigh the potential noise reduction loss.

Anti saturation

Dolby S-type includes **Anti saturation** high frequency shelving networks in the encoder which operate only at (loud) high signal levels, just like Dolby C-type. However, in Dolby S-type, the **Spectral Skewing** networks also contribute to **Anti saturation** as well. Compact cassettes use a standard equalization (3180 microseconds) which boosts low frequencies during recording and cuts them equally during playback. However, when attempting to record loud bass sounds, the tape can become saturated (over loaded) due to this equalization boost. Because Dolby S-type provides noise reduction at low frequencies, in Dolby S-type encoders, the standard cassette equalization is eliminated. This results in a noticeable reduction in distortion on recordings of strong (loud) low frequency signals.

The combined effects of **Spectral Skewing** and **Anti saturation** techniques at both low and high frequencies can be seen in Figure 13, which illustrates Dolby S-type's overall encode characteristics. [Figure 14](#) is a Block Diagram of the Dolby S-type Noise Reduction system.

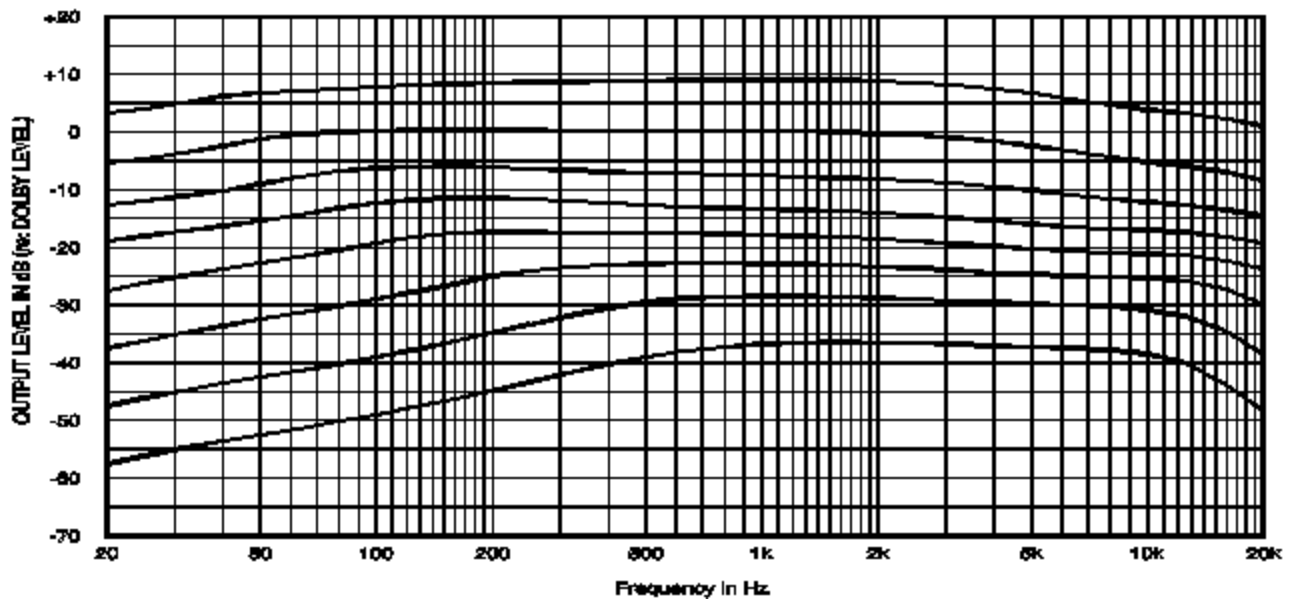

Figure 13. *Dolby S-type encode characteristics, showing the effects of spectral skewing and antisaturation at various input levels. The decode characteristics are the inverse of these curves.*

Dolby S-Type Performance

"We have found that, at the highest playback levels likely to be encountered in the home, sophisticated listeners subjected to A/B comparisons of CDs and Dolby S-type cassettes are unable to identify which is which with any regularity."

Although the benefits of a Dolby S-type recording will only be fully realized with S-type decoding, Dolby S-type has been designed so that it can be played quite acceptably via B-type decoder equipment such as car stereo players, battery operated portable players, or existing Hi Fi decks, or even via equipment without decoding capability. This makes Dolby S-type ideal for pre-recorded tape use. In fact, RCA Victor, BMG Classics, Warner Brothers Records, and Atlantic Records have already produced over 30 million pre-recorded tapes encoded in Dolby S-type.

Dolby S-type encoding reduces the dynamic range (quieter sounds are brought up in level, while loud ones are left alone). In noisy surroundings, such as cars, trains, or planes, it is no longer necessary to keep turning the volume up and down as the level of the music changes. This benefit is enjoyed even if a Dolby S-type decoder is not used.

SUMMARY OF DOLBY S-TYPE NOISE REDUCTION BENEFITS

- Dolby S-type Cassette Decks are the highest quality designs.
- Dolby S-type Cassette Decks provide performance comparable to that of a Compact Disc, utilizing standard (Type I) blank cassette tapes.
- Sonically, Dolby S-type noise reduction gives cleaner transient response, provides lower noise levels, both at low and high frequencies, and allows higher signal levels to be recorded safely; in short, it permits more accurate recording. Over 30 million pre-recorded cassettes have been produced using Dolby S-type noise reduction.
- In noisy environments, when tapes encoded with Dolby S-type noise reduction, whether pre-recorded or recorded in the home, are played back with Dolby B-type noise reduction, or even with no noise reduction, they will sound better than they would if Dolby S-type noise reduction had not been used.

TECHNICALLY SPEAKING

Dolby S-type Noise Reduction utilizes combined fixed and sliding type compression-expansion bands in two different high frequency bands as well as a fixed type band for low frequencies. It provides 24 dB of High Frequency Noise Reduction plus an additional 10 dB of Low Frequency Noise Reduction.

Dolby S-type's MODULATION CONTROL helps to keep all low-level signals in a more constantly boosted state which makes noise reduction more effective.

SPECTRAL SKEWING and ANTI SATURATION networks have been used to provide significantly increased headroom and to reduce decoder mistracking due to recorder generated errors.