

ICTP-ITU-URSI School on Wireless Networking for Development
The Abdus Salam International Centre for Theoretical Physics ICTP, Trieste (Italy), 6 to 24 February 2006

Radio-wave propagation basics

Ryszard Struzak
www.ryszard.struzak.com

Property of R. Struzak

Purpose

- The purpose of the lecture is to refresh radio wave propagation physics (basics) needed to understand the operation of wireless local area networks

Topics for discussion

- Why consider propagation?
- What is Free-space, Fresnel zone, etc.?
- What are long-term and short term modes?
- What are reflections effects?
- What is DTM and how to produce it?
- ...

Important notes

- Copyright © 2006 Ryszard Struzak. This work is licensed under the Creative Commons Attribution License (<http://creativecommons.org/licenses/by/1.0>) and may be used freely for individual study, research, and education in not-for-profit applications. Any other use requires the written author's permission. These materials and any part of them may not be published, copied to or issued from another Web server without the author's written permission. If you cite these materials, please credit the author.
- Beware of misprints!!! These materials are preliminary notes for my lectures and may contain misprints. If you notice some, or if you have comments, please send these to r.struzak@ieee.org.

Lightning



Source: Wikipedia

• <http://en.wikipedia.org/wiki/Lightning>

- Natural phenomenon known from the beginning of human existence
- Effects:
 - Lightning flash, Acoustic pulse, Heat stroke, EM pulse,
 - Can destroy electronic and electric networks, trees, buildings, etc.
- Continuing studies:
 - Artificially provoked lightning's to facilitate observations/measurements

Basic concepts

Classical physics

~100 years from Coulomb to Maxwell

~100 years from Maxwell to IEEE 802.11

Coulomb (1736-1806)

Galvani (1737-1798)

Volta (1745-1827)

Ampere (1775-1836),

Faraday (1791-1867)

Henry (1791-1878),

Maxwell (1831-1879)

Heaviside (1850-1925)

Tesla (1853-1943)

Hertz (1857-1894)

Popov (1859-1906)

Marconi (1874-1937)

What is EM field?

- A spatial distribution of stress
 - forces acting on an electric charge
 - A pair of vectors E and H
 - (Magnitude, Direction, Orientation)
 - Varying in time and space
 - Six numbers at every point:
 - $E_x(x,y,z,t)$, $E_y(x,y,z,t)$, $E_z(x,y,z,t)$
 - $H_x(x,y,z,t)$, $H_y(x,y,z,t)$, $H_z(x,y,z,t)$

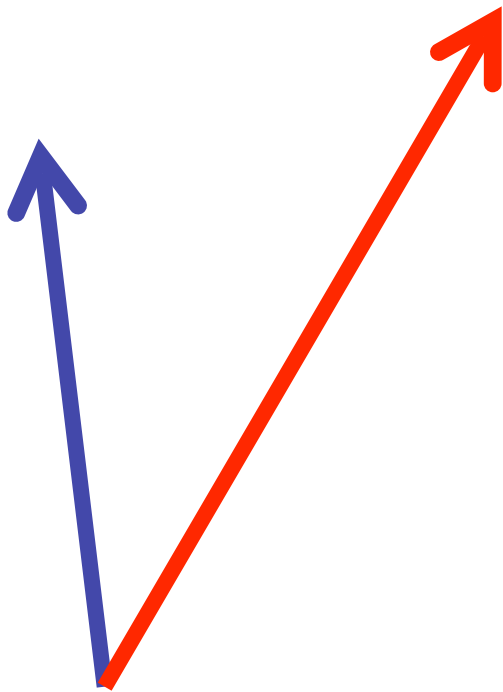

EM interactions

- EM fields interact with the matter
 - Electric component (E) interacts with electric charges, fixed and moving
 - Magnetic component (H) interacts only with moving electric charges
- Electricity and magnetism were considered as separate (and mysterious) phenomena (until Maxwell)

Classic theory

- EM wave is associated with accelerating/ decelerating charges
 - When an electric charge accelerates or decelerates, EM wave is produced
 - When EM wave acts on an electric charge, it accelerates or decelerates
- Maxwell equations (+ Hertz, + Heaviside)
 - <http://www.amanogawa.com/archive/wavespdf.html>

Quiz: How strong?

- Imagine 2 persons at 1 m distance.
 - Their bodies consist of balanced set of electrons & protons, but - by some magic - we decrease the number of protons by 1% in each
 - Now they have more electrons than protons -- they repulse each other
 - How strong is the repulsive force?
 - Could it be strong enough to move a hair?
Or stronger?

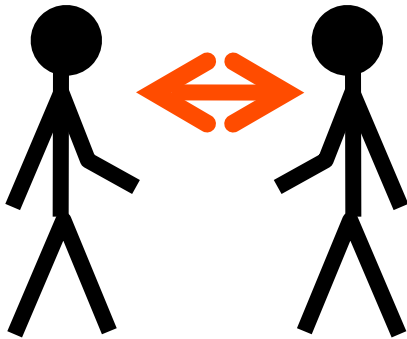

- The force would be strong enough to lift the whole Earth!

– As calculated by
Richard Feynman



Quiz: How far?

- At which distances the EM forces act?
 - At meter distances? Or thousand kilometers?



[Click image to enlarge](#)

- Classic electromagnetic theory does not impose any distance limits
 - » In vacuum or in uniform dielectric lossless material
- EM energy is radiated into space where it travels to infinity.
 - » During the travel, the EM energy can transform into another form
- Evidence:
 - We see light (i.e. visible EM waves) from stars and galaxies
 - EM forces generated there move electrons on the Earth!

Quiz: How long?

- How long the EM forces can last?
 - Seconds? Hours? Years?

- Classic EM theory does not impose any time limits
 - for EM waves in vacuum or in unlimited dielectric
- Arno Penzias & Robert Wilson, of Bell Telephone Labs, observed in 1965 the residual cosmic (galactic) radio noise
 - » (i.e. chaotic EM forces moving electrons in their antenna)
- They showed that the noise has been generated in a specific moment billions years ago!
- It was a strong experimental argument in support the Big-Bang theory of the Origin of the Universe. They have got the 1978 Nobel Prize
 - » Electric charges that caused them ceased to exist in the meantime (like lasting lightning effects)

- A consequence:
 - The EM field in any point around us is a result of vector combination of uncountable components coming from the Universe
 - Generated by natural processes and by man-made devices during the past time elapsed from the big-bang up to present moment
 - Such is the environment in which we live and in which modern wireless communication systems have to operate

Simplest waves

TEM - simplest EM wave

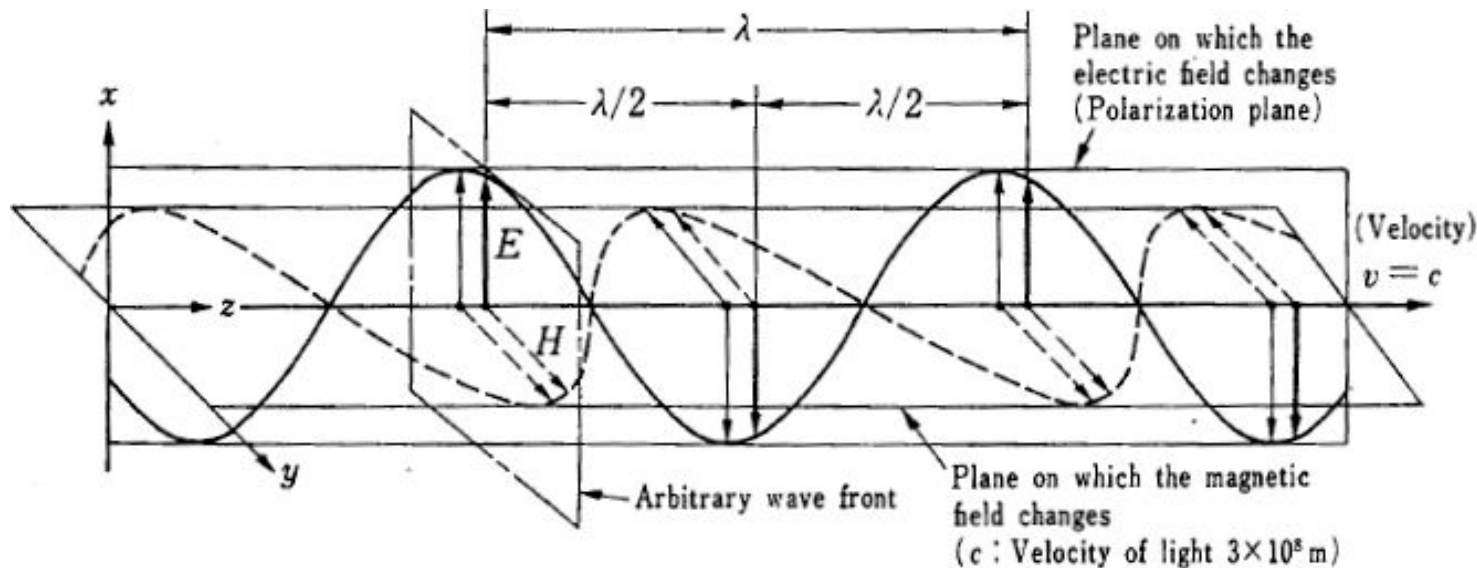

Linearly-polarized plane wave traveling in vacuum with the speed of light:

$$(x, t) = A \sin[\omega(t - x/c) + \varphi]; \quad \omega = 2\pi F; \quad c \sim 3 \cdot 10^8 \text{ m/s}$$

Demo propag: <http://www.amanogawa.com/archive/wavesA.html>

Power vs. field-strength

- $[E] = \text{V/m}$
- $[H] = \text{A/m}$
- TEM plane wave in vacuum:
 - $E \perp H \perp$ direction of wave propagation
 - $E/H = 120\pi$ (~ 377) ohm - wave impedance
 - PDF (Power-flux-density) –
 - $P_1 = E \times H \text{ W/m}^2$
 $= E^2 / 120\pi \text{ W/m}^2$

Energy spreading

- Sometimes one ignores vectorial character of EM waves, considering PDF (energy treated as scalar)
- Spherical spreading:
 - » $\text{PDF} = \text{EIRP}/(4\pi d^2)$ decreases with distance squared (in vacuum)
- Planar spreading (2-D duct):
 - » $\text{PDF} = \text{EIRP}/(a2\pi d)$ decreases with distance (vacuum)
- No spreading (planar wave; 1-D duct):
 - » $\text{PDF} = \text{EIRP}/(b^2)$ does not depend on distance (vacuum)
 - PDF: power-flux density, W/m^2
 - EIRP: equivalent isotropically radiated power, W
 - a : duct equivalent size, m
 - b : duct equivalent cross-section, m^2
 - d : distance from the radiation source (transmitter), m

Vectorial power-flow treatment: <http://www.amanogawa.com/archive/docs/EM8.pdf>

Frequency

$$f = \frac{c}{\lambda}$$

$$c \approx 3 \times 10^8 \text{ m/s}$$

- A linear radio frequency scale of 1Hz = 1/3 mm (10⁹m) would extend beyond the Moon (3.8x10⁸m)
- Almost all RF spectrum is regulated and allocated to various services

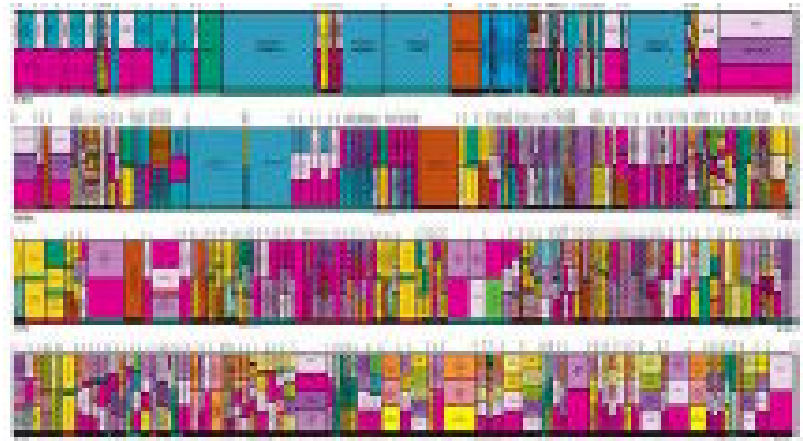
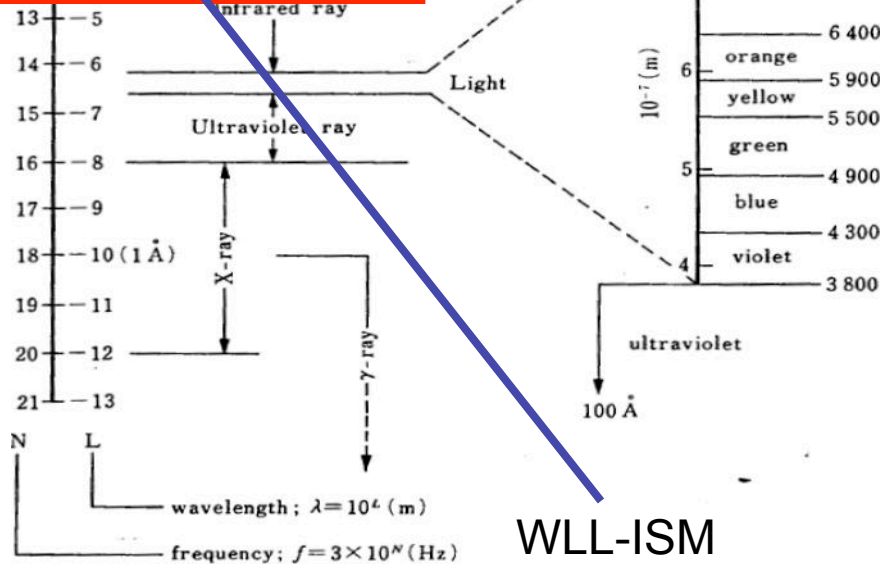
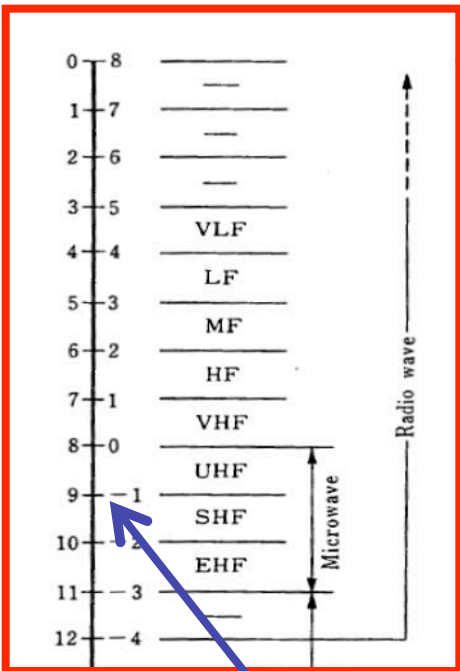

Prefixes

Numerical multiplier prefix

10^{18}	E (exa)		10^{-1}	d (deci)
10^{17}			10^{-2}	c (centi)
10^{16}			10^{-3}	m (milli)
10^{15}	P (peta)		10^{-4}	
10^{14}			10^{-5}	
10^{13}			10^{-6}	μ (micro)
10^{12}	T (tera)		10^{-7}	
10^{11}			10^{-8}	
10^{10}		$10^0 = 1$	10^{-9}	n (nano)
10^9	G (giga)		10^{-10}	
10^8			10^{-11}	
10^7			10^{-12}	p (pico)
10^6	M (mega)		10^{-13}	
10^5			10^{-14}	
10^4			10^{-15}	f (femto)
10^3	k (kilo)		10^{-16}	
10^2	h (hecto)		10^{-17}	
10^1	da (deca)		10^{-18}	a (atto)

Latency & frequency shift

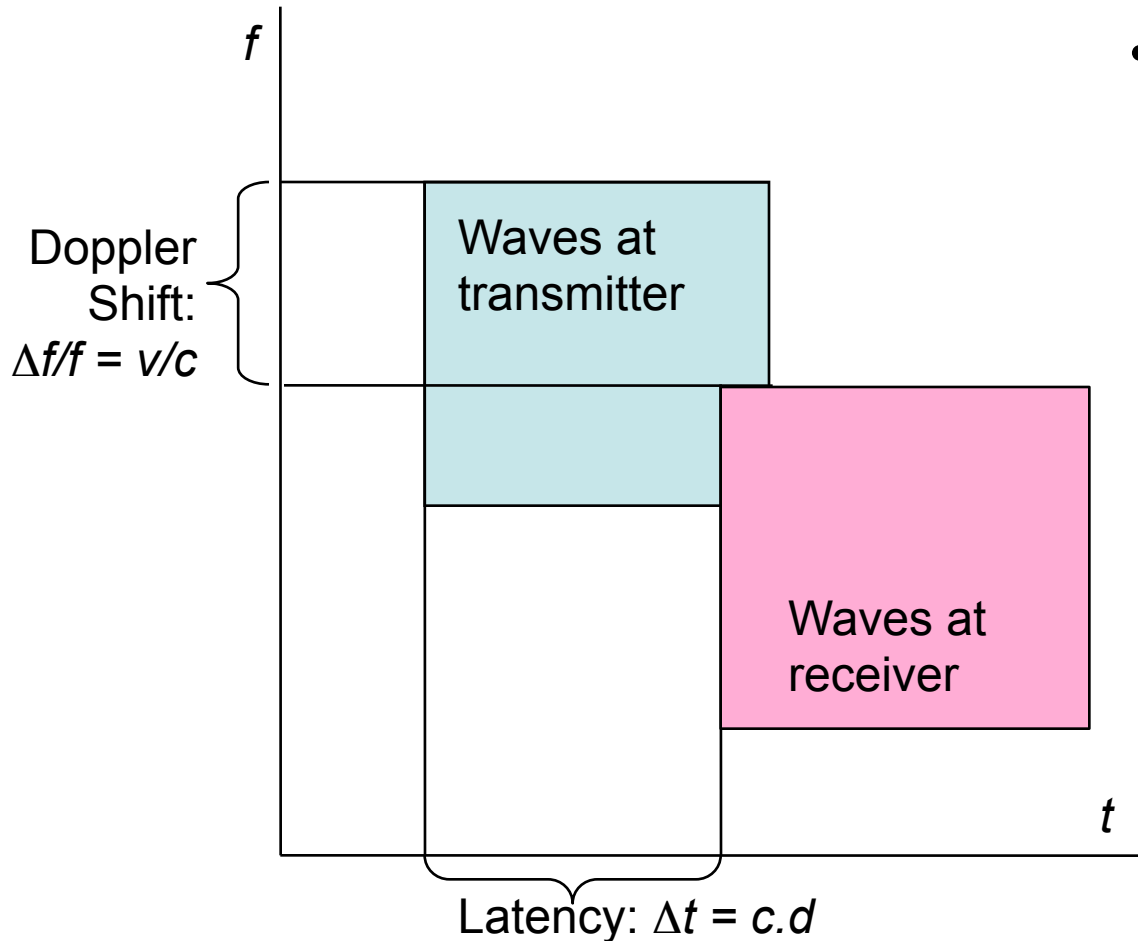

- Consequences of limited velocity of radio wave:
 - Received wave is delayed due to the travel time
 - Received wave-frequency is shifted due to Doppler effect (if transmitter and receiver move)

Quiz

- What is latency of signals
 - From HAPS (dist. 20 km)? <http://en.wikipedia.org/wiki/HAPS>
 - From International Space Station (360 km)? http://en.wikipedia.org/wiki/International_Space_Station
 - From a geostationary satellite (35,786 km)? http://en.wikipedia.org/wiki/Geostationary_satellite
 - From Voyager 1 cosmic sonde (14.2 billion km) http://en.wikipedia.org/wiki/Voyager_1#Distance_travelled

Doppler effect

= the apparent change in frequency of a wave that is perceived by an observer moving relative to the source of the wave

- » http://en.wikipedia.org/wiki/Doppler_effect
- » Simulation: <http://www.falstad.com/ripple/ex-doppler.html>



Johann Christian Andreas Doppler (1803 – 1853; Austrian mathematician and physicist) http://en.wikipedia.org/wiki/Christian_Doppler

Quiz

- What is Doppler shift of 3 GHz signal received at a fixed station
 - From a car (100 km/h)?
 - From jet aircraft (1000 km/h)?
 - From Voyager-1 cosmic vehicle (17.2 km per second)?

Phase representation

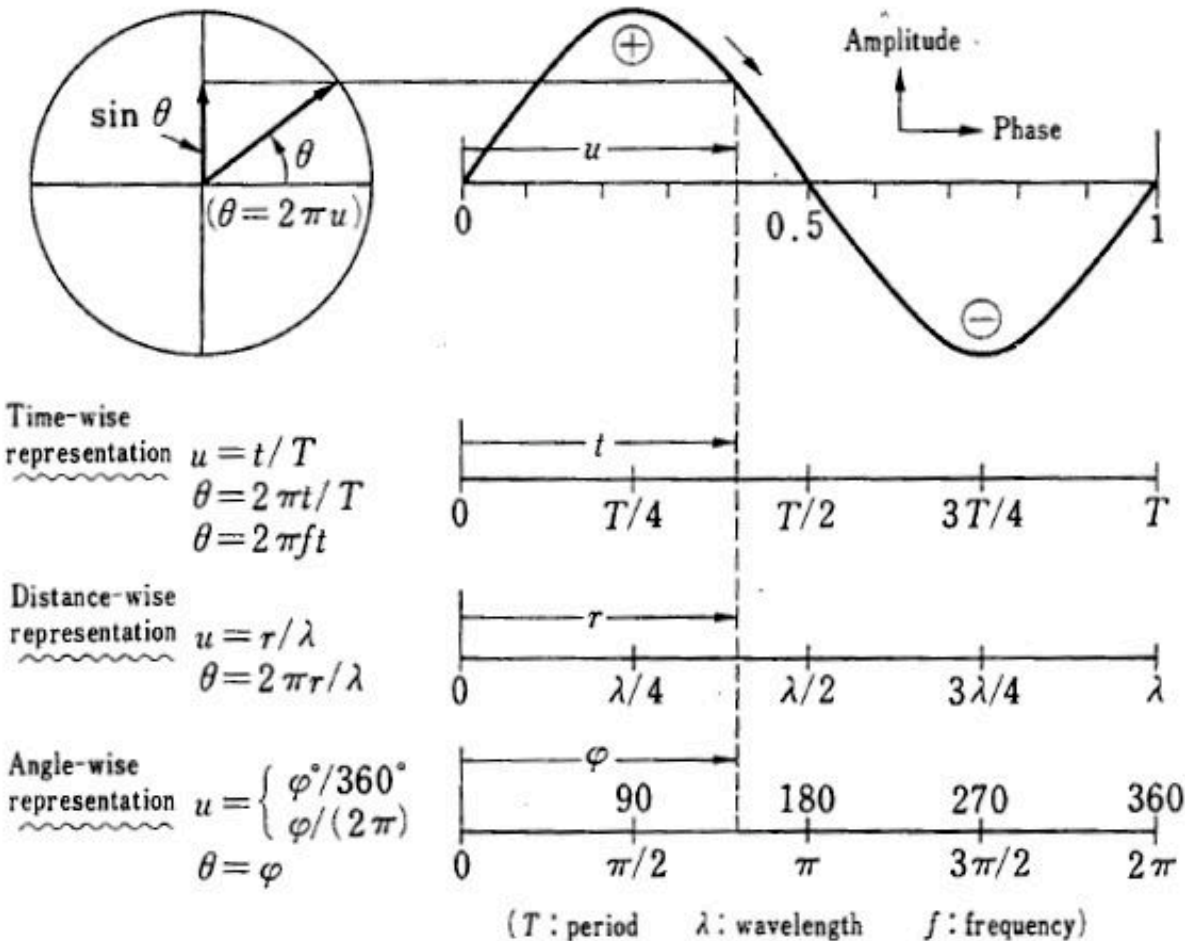

Sum of two linearly-polarized waves

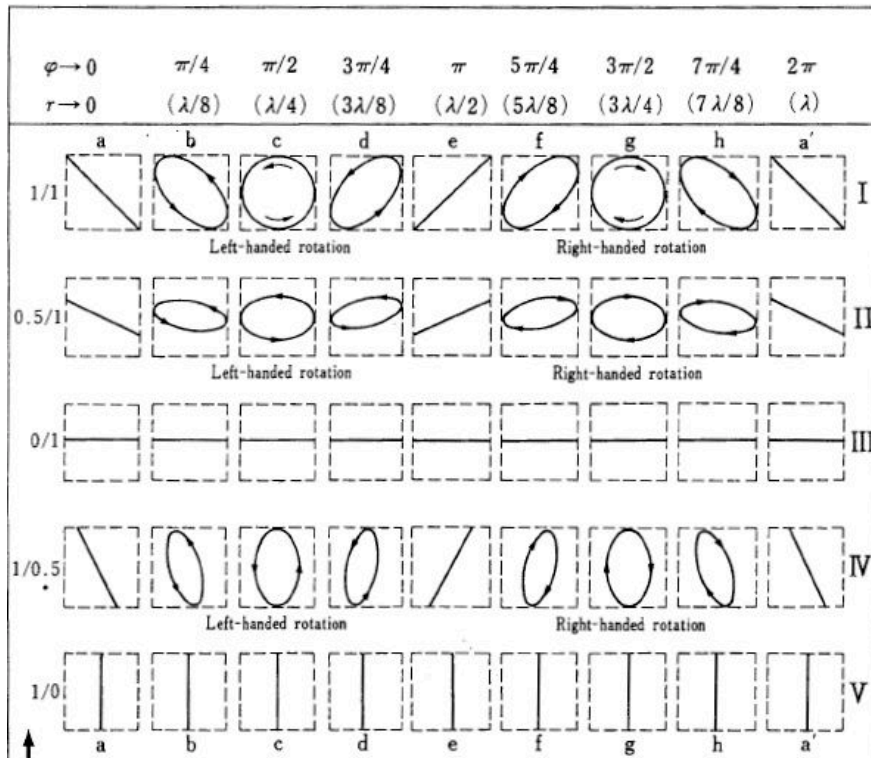
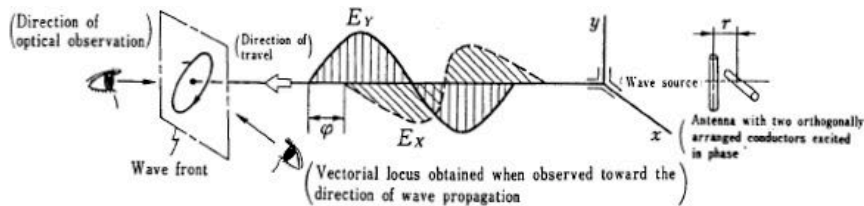

Demo polariz: <http://www.amanogawa.com/archive/wavesA.html>

E_y/E_x
Amplitude ratio)

Polarization

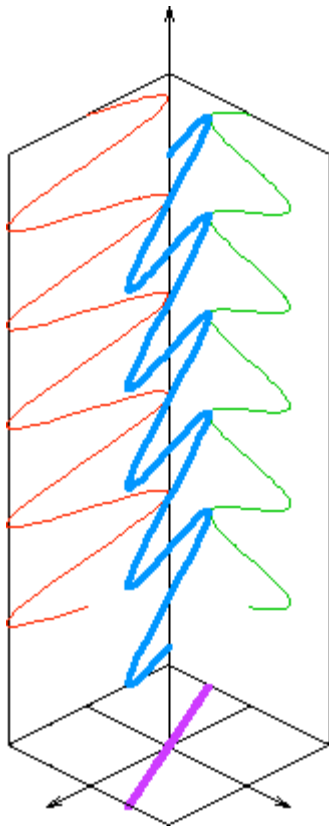

Linear

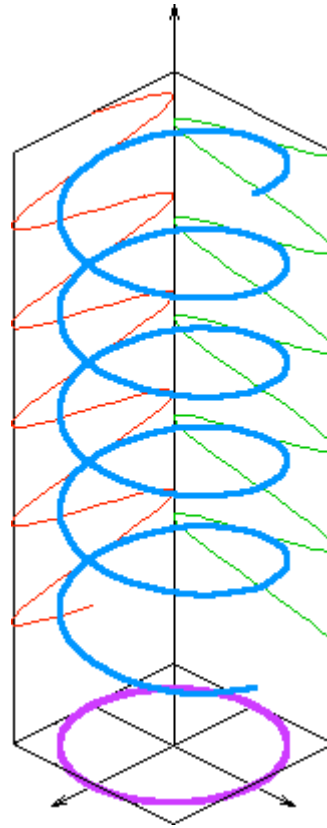

Circular

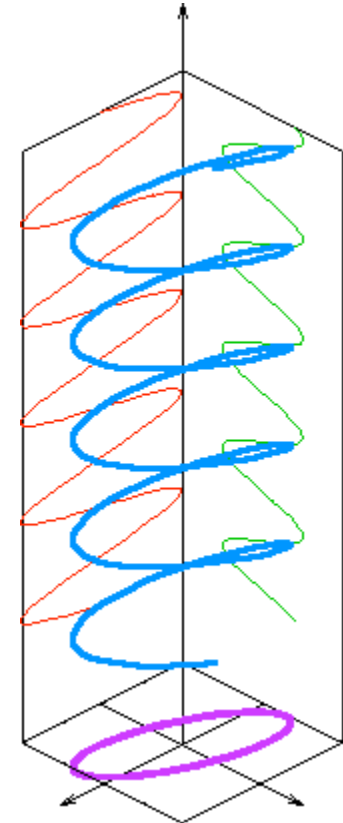

Elliptical

<http://en.wikipedia.org/wiki/Polarization>

Polarization ellipse

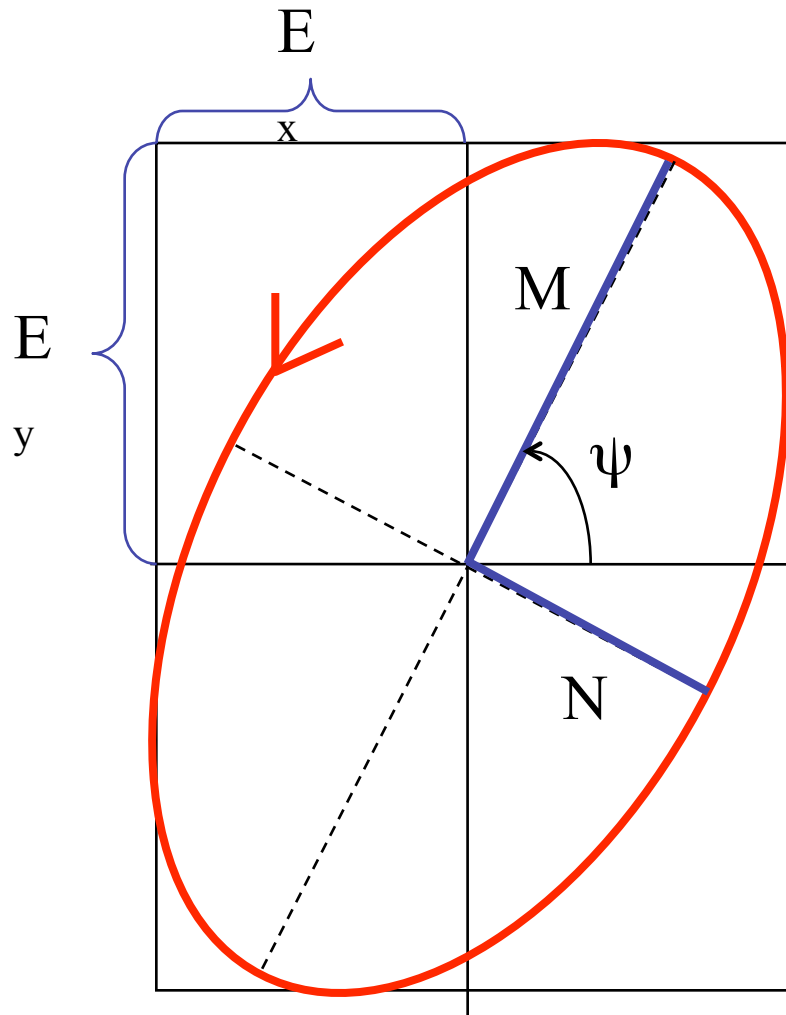

- The superposition of two plane-wave components results in an elliptically polarized wave
- The polarization ellipse is defined by its axial ratio N/M (ellipticity), tilt angle ψ and sense of rotation

– Interactive applets on wave propagation physics

- <http://www.amanogawa.com/archive/wavesA.html>
- <http://www.falstad.com/mathphysics.html>

Comments on Polarization

- At any moment in a chosen reference point in space, there is actually a single electric vector E (and associated magnetic vector H).
- This is the result of superposition (addition) of the instantaneous vectors E (and H) produced by all radiation sources
- The separation of fields by their wavelength, polarization, or direction is the result of 'filtration'

Radio link

Radio transmission: 2 viewpoints

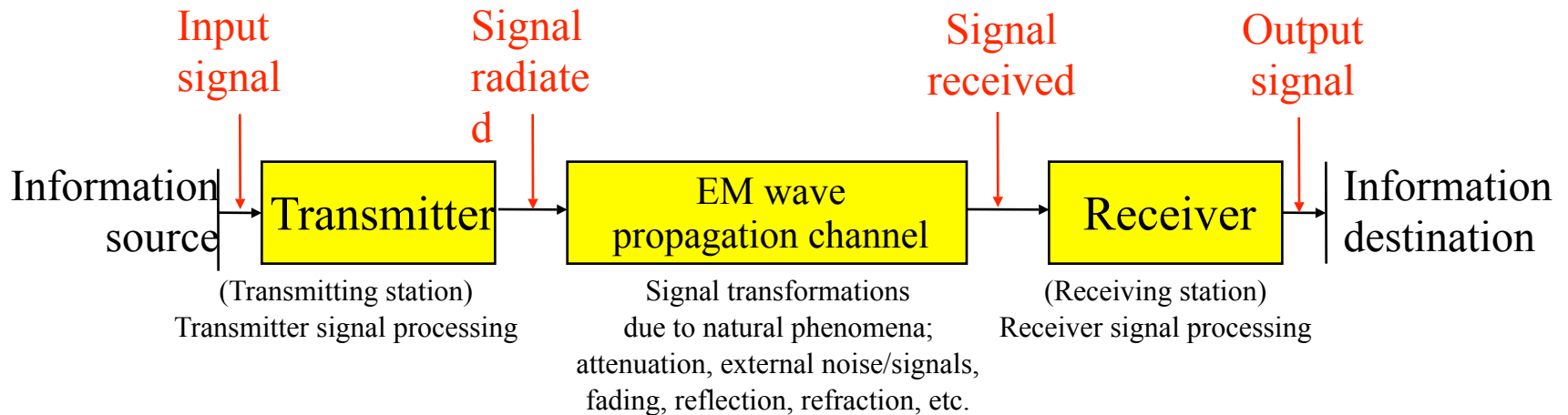
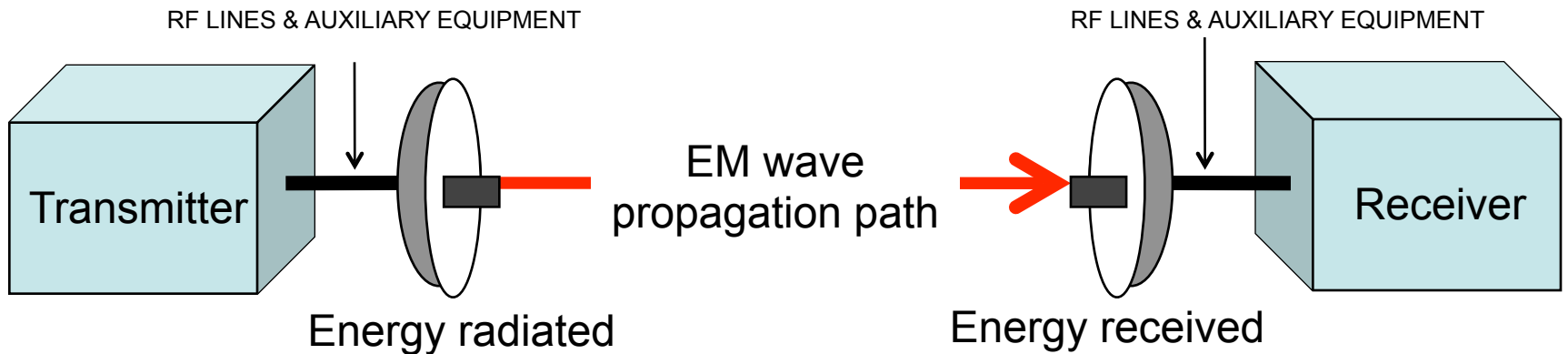

Radio Link model

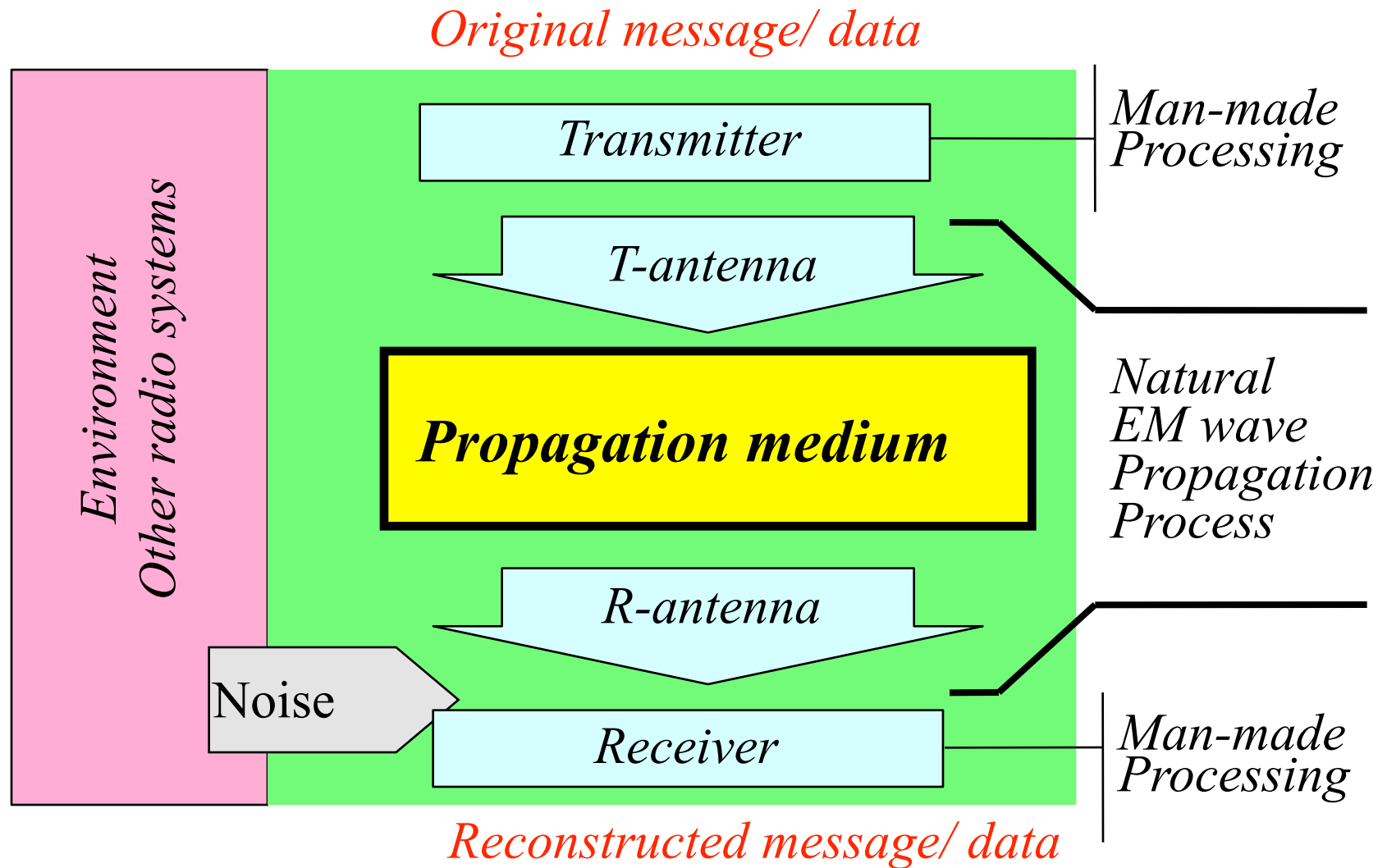

Why consider propagation?

1. Could my system operate correctly (wanted signal)?

- Required signal intensity/ quality of service over required distance/ area/ volume, given the geographic/ climatic region and time period

2. Could my system coexist with other systems (unwanted signals)?

- Degradation of service quality and/ or service range/ area due to potential radio interference?
 - Will my system suffer unacceptable interference?
 - Will it produce such interference to other systems?

Principal propagation effects

1. Basic energy spreading
2. Effects of obstructions (indoor, outdoor)
3. Effects of the ground
4. Tropospheric effects (outdoor)
 - clear air
 - non-clear air
5. Ionospheric effects (outdoor)

Generally, dependence on

- Wavelength (frequency) & polarization
- Environment/ climate/ weather
- Time

What is propagation model?

- Relation between the signal radiated and signal received as a function of distance and other variables
- Different models
 - Various dominating propagation mechanisms
 - different environments (indoor-outdoor; land-sea-space; ...)
 - different applications (point-to-point, point-to-area, ...)
 - different frequency ranges
 - ...
- Some models include random variability

Indoor propagation

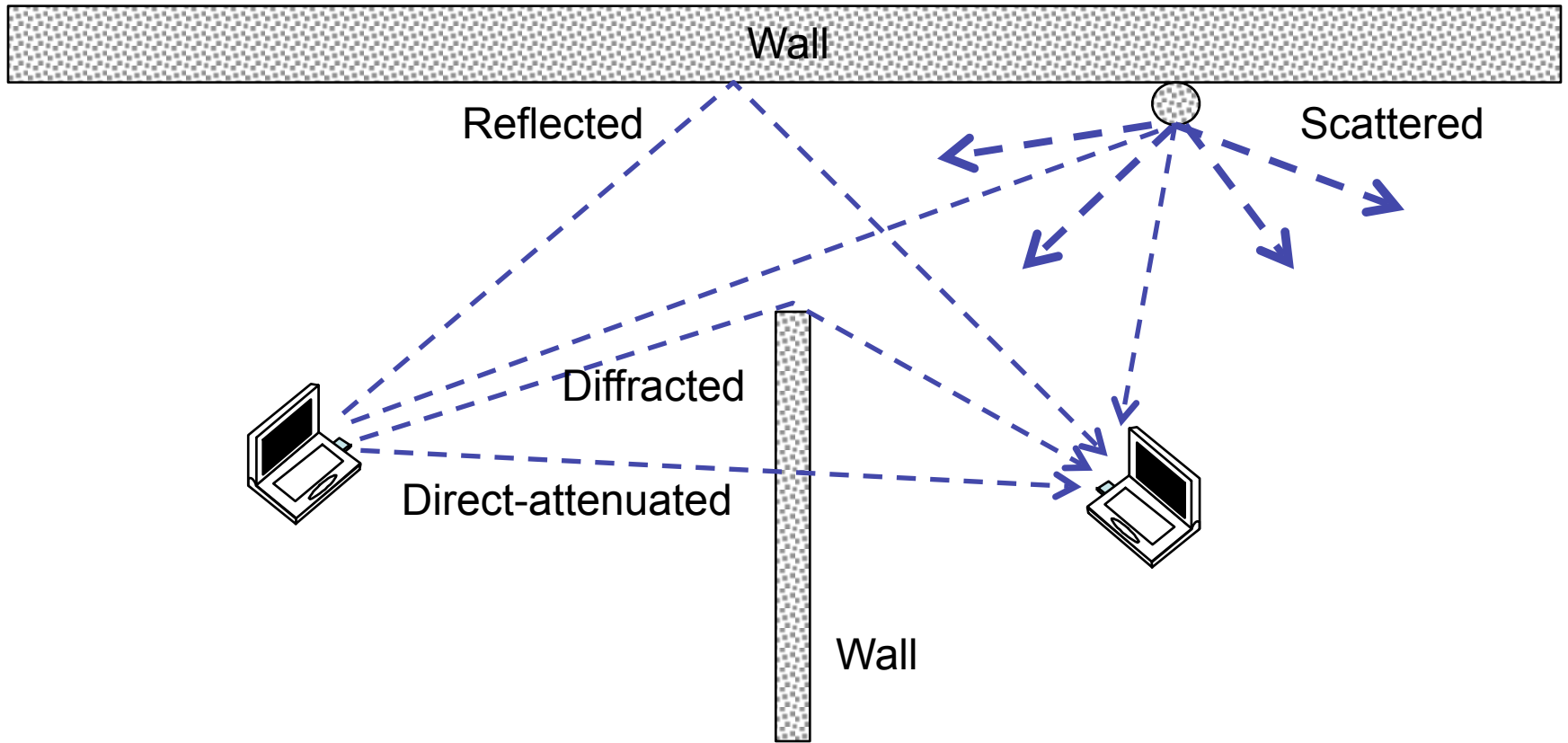

Outdoor propagation: long-term modes

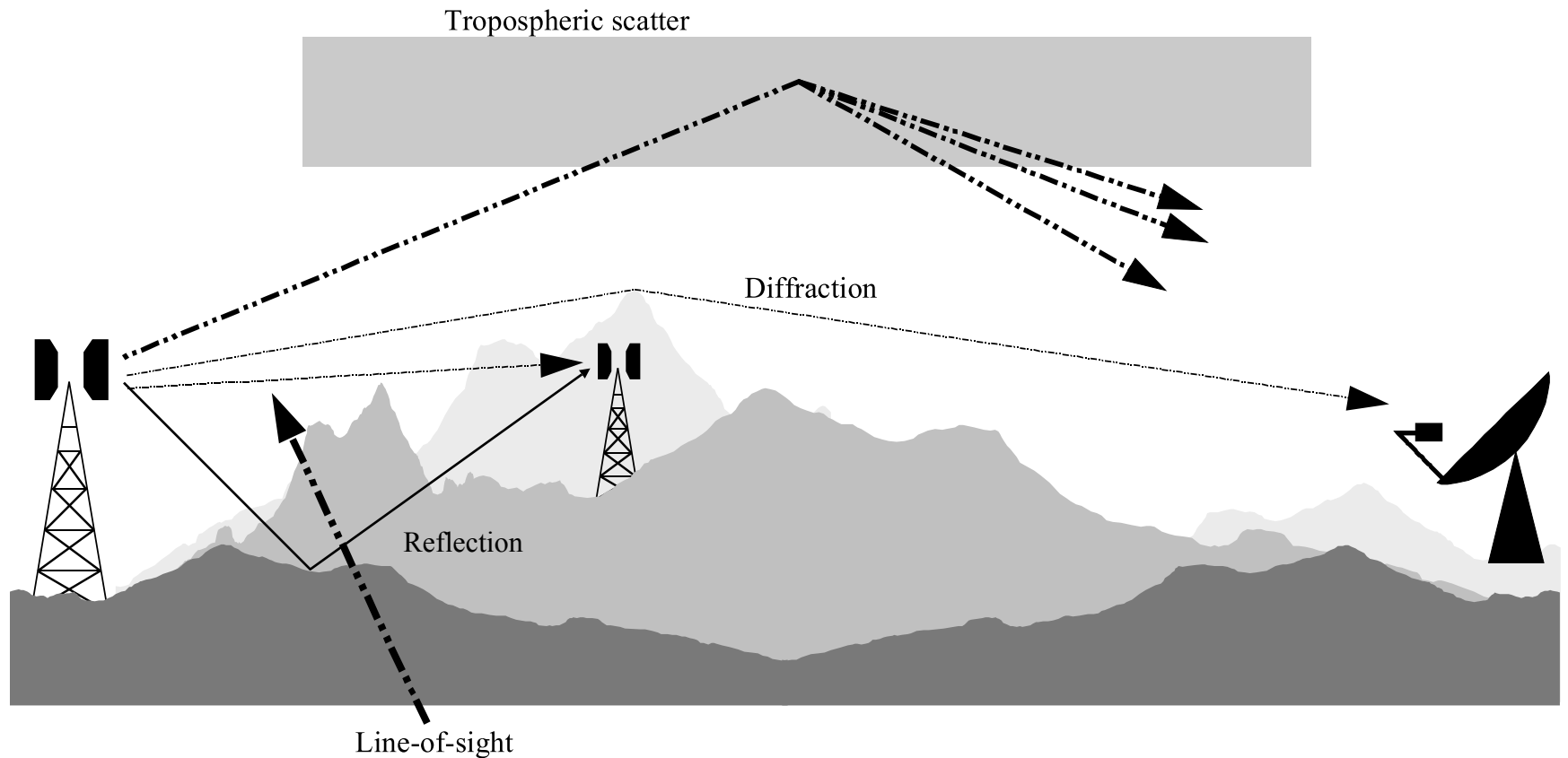

Outdoor propagation: short-term modes

Anomalous (short-term) interference propagation mechanisms

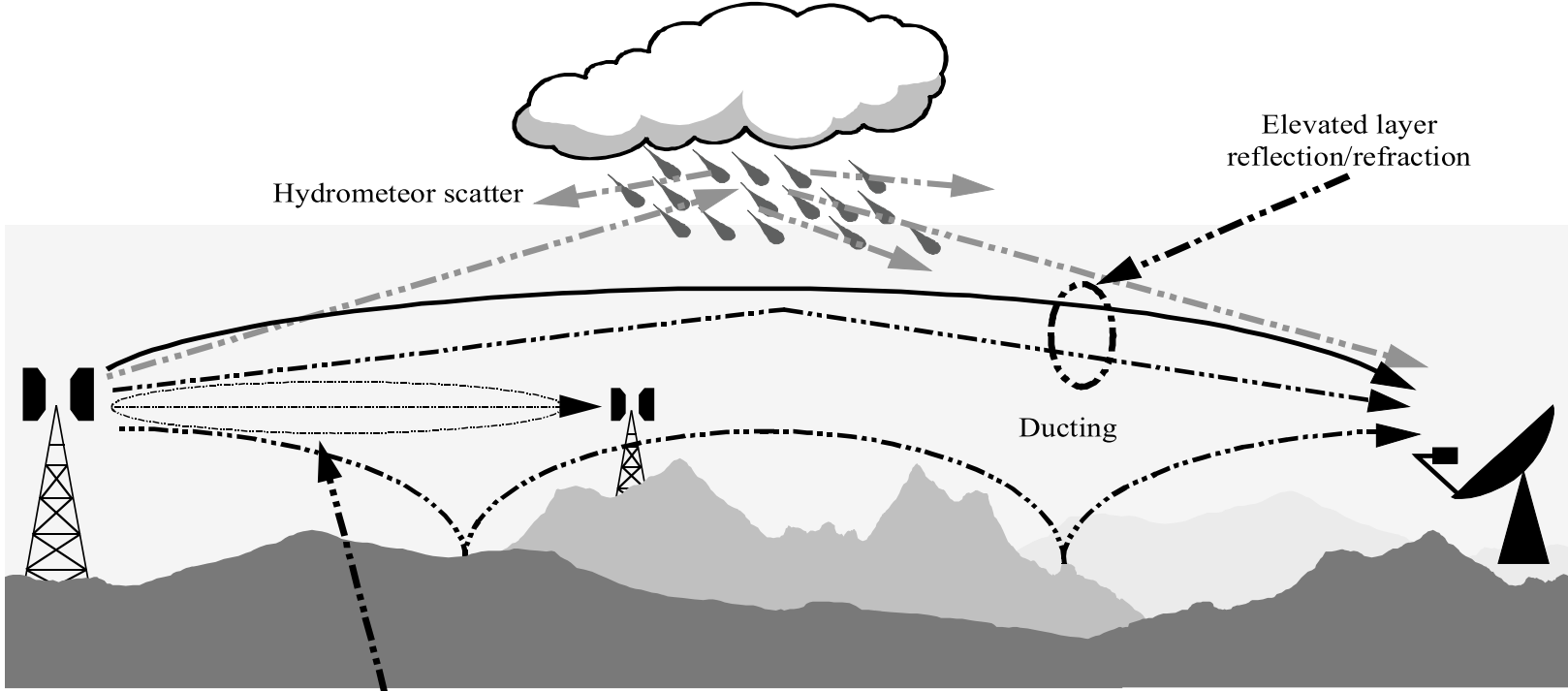

Line-of-sight with multipath enhancements

Ionospheric “reflections”

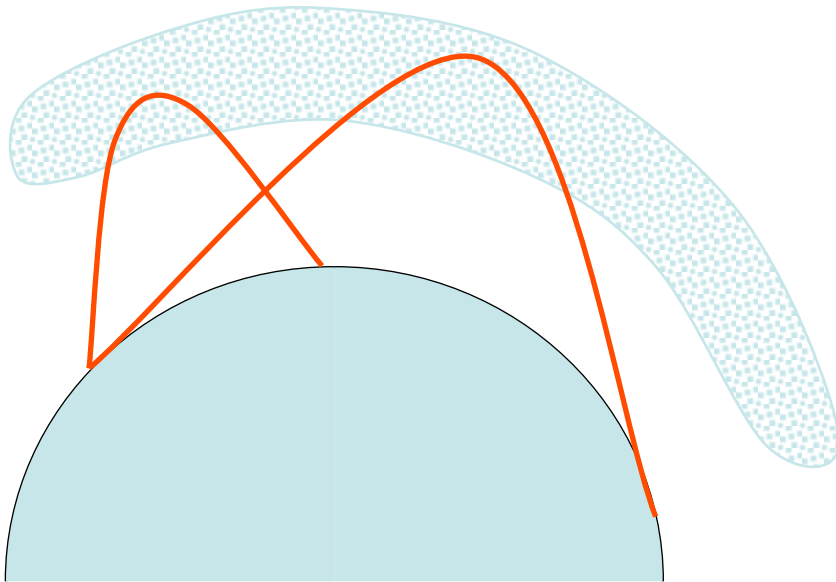

Ionospheric reflectivity depends on time, frequency of incident wave, electron density, solar activity, etc. Difficult to predict with precision.

- The ionosphere is transparent for microwaves but reflects HF waves
- There are various ionospheric layers (D, E, F1, F2, etc.) at various heights (50 – 300 km)
- Over-horizon communication range: several thousand km
- Suffers from fading

Basic mechanisms

Radio Wave Components

<i>Component</i>	<i>Comments</i>
Direct wave	Free-space/ LOS propagation
Attenuated wave	Through walls etc. in buildings, atmospheric attenuation (>~10 GHz)
Reflected wave	Reflection from a wall, passive antenna, ground, ionosphere (<~100MHz), etc.
Refracted wave	Standard, Sub-, and Super-refraction, ducting, ionized layer refraction (<~100MHz)
Diffraction wave	Ground-, mountain-, spherical earth- diffraction (<~5GHz)
Surface wave	(<~30 MHz)
Scatter wave	Troposcatter wave, precipitation-scatter wave, ionized-layer scatter wave

Reflection

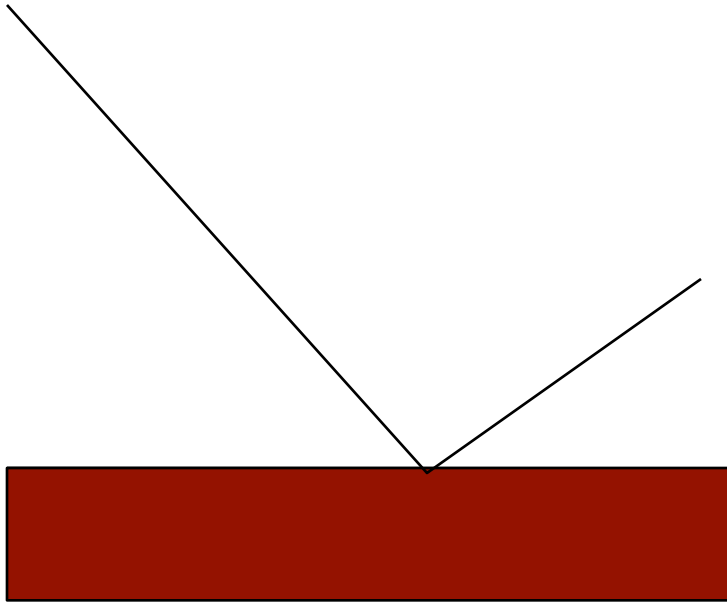

- = the abrupt change in direction of a wave front at an interface between two dissimilar media so that the wave front returns into the medium from which it originated.
- Reflecting object is large compared to wavelength.

Scattering

- - a phenomenon in which the direction (or polarization) of the wave is changed when the wave encounters propagation medium discontinuities smaller than the wavelength (e.g. foliage, ...)
- Results in a disordered or random change in the energy distribution

Diffraction

- = the mechanism the waves spread as they pass barriers in obstructed radio path (through openings or around barriers)
- Diffraction - important when evaluating potential interference between terrestrial/stations sharing the same frequency.

Absorption

- = the conversion of the transmitted EM energy into another form, usually thermal.
 - The conversion takes place as a result of interaction between the incident energy and the material medium, at the molecular or atomic level.
 - One cause of signal attenuation due to walls, precipitations (rain, snow, sand) and atmospheric gases

Refraction

- = redirection of a wavefront passing through a medium having a refractive index that is a continuous function of position (*e.g.*, a graded-index optical fibre, or earth atmosphere) or through a boundary between two dissimilar media
 - For two media of different refractive indices, the angle of refraction is approximated by Snell's Law known from optics

Super-refraction and ducting

Atmospheric refraction effects on radio signal propagation

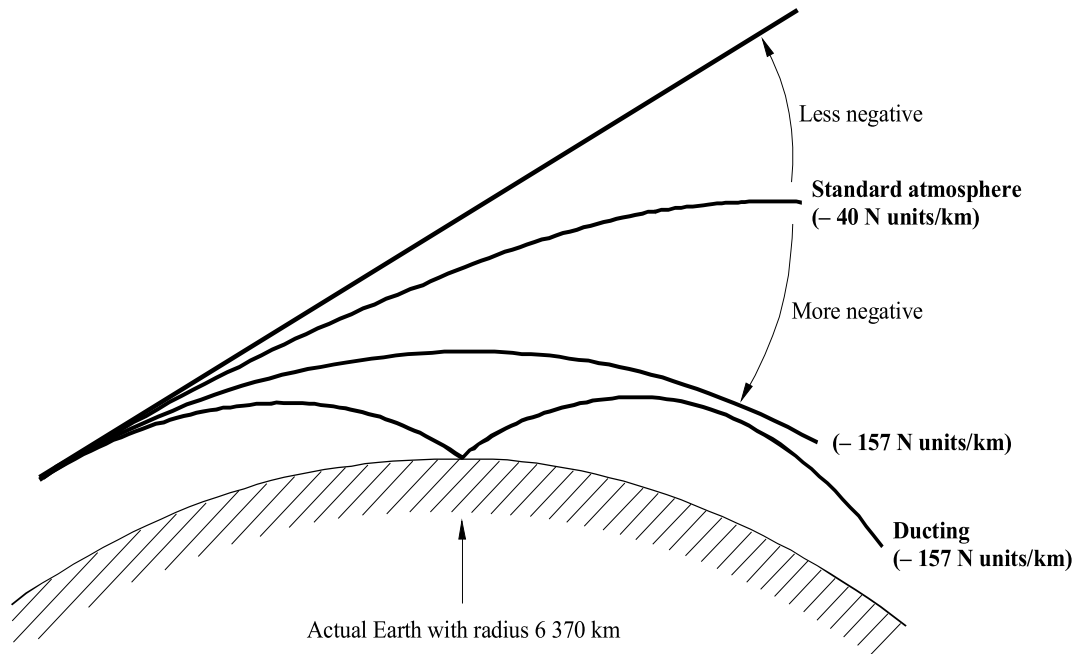

Standard atmosphere: -40 N units/km (median), temperate climates
Super-refractive atmosphere: < -40 N units/km, warm maritime regions
Ducting: \leq -157 N units/km (fata morgana, mirage)

Important when evaluating potential interference between terrestrial/ earth stations sharing the same frequency

- coupling losses into duct/layer
 - geometry
- nature of path (sea/ land)
- propagation loss associated with duct/ layer
 - frequency
 - refractivity gradient
 - nature of path (sea, land, coastal)
 - terrain roughness

Simplest models

The simplest model: Free-space

$$P_R = P_T \times G_{TR} \times G_{RT} \times \left(\frac{\lambda}{4\pi d_{TR}} \right)^2$$

$$P_{RdB} = P_{TdB} + G_{TRdB} + G_{RTdB} + 10 \log_{10} \left(\frac{\lambda}{4\pi d_{TR}} \right)^2$$

P_T = transmitted power [W]

d = distance between antennas Tx and Rx [m]

P_R = received power [W]

G_T = transmitting antenna power gain

G_R = receiving antenna power gain

P_R/P_T = free-space propagation (transmission) loss (gain)

Notes:

1. Propagation of a plane EM wave in a homogeneous ideal absorption-less medium (vacuum) unlimited in all directions.
2. Doubling the distance results in four-times less power received; the frequency-dependence is involved (antenna gains vary with frequency)
3. Matched polarizations
4. Specific directions

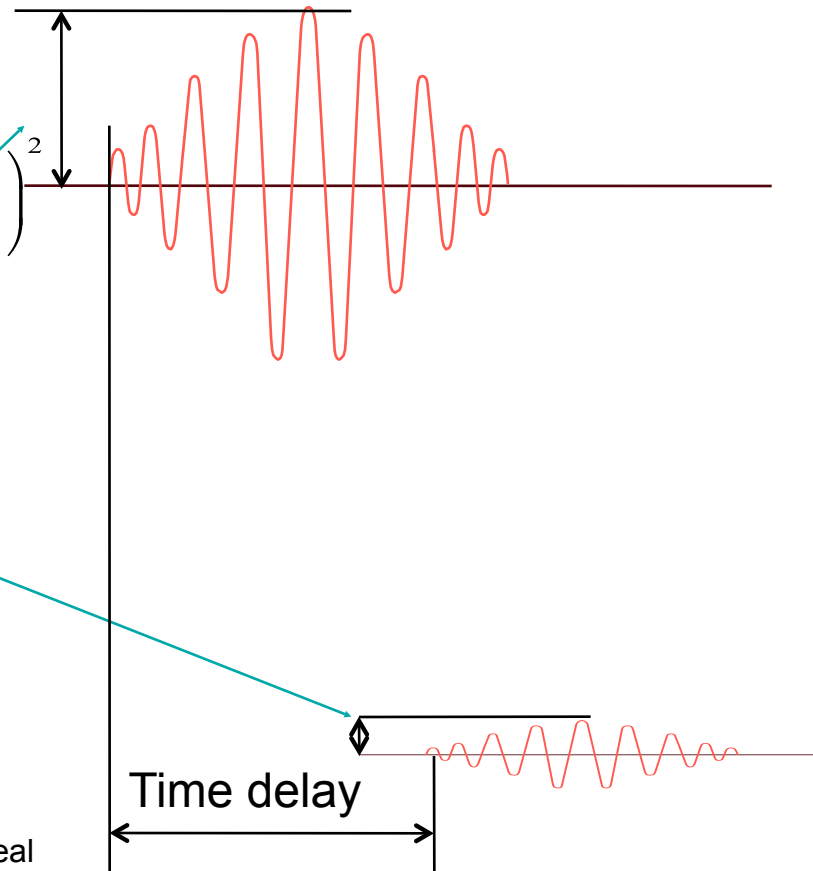

LOS model

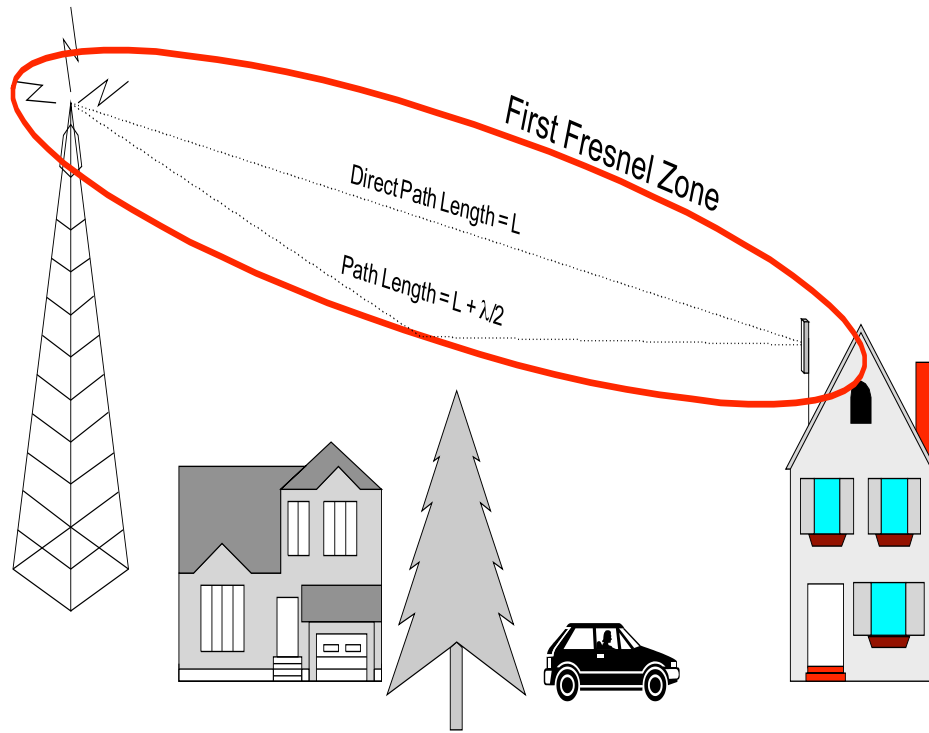

Avaya

- Power flow from T to R concentrates in the 1st Fresnel zone
- LOS model approximates the free-space model if:
 - 1st Fresnel zone unobstructed
 - no reflections, absorption & other propagation effects

Fresnel Zone

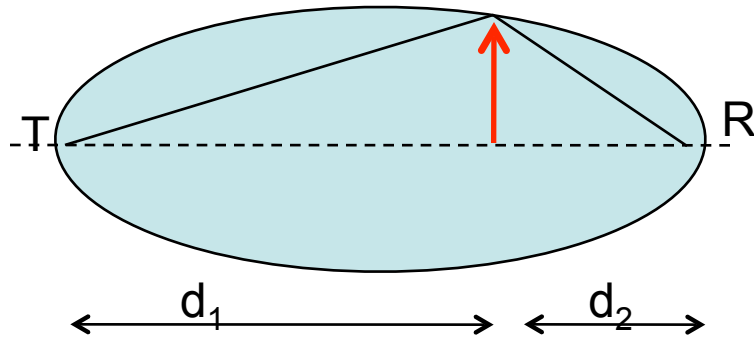

$$r_1 = \sqrt{\frac{\lambda d_1 d_2}{d}} \leq \frac{1}{2} \sqrt{\lambda d}$$

r_1 : radius of the 1st Fresnel zone, m

$d = d_1 + d_2$: distance T-R, m

λ : wavelength, m

d_1, d_2 : distance to R and to T, m

Example: max. radius of the 1st Fresnel zone
at 3 GHz ($\lambda = 0.1\text{m}$) with T – R distance of 4 km:
 $= (1/2)\text{sqrt}(0.1*4000) = 10\text{m}$

- Fresnel zones are loci of points of constant path-length difference of $\lambda/2$ (180° phase difference)
 - The n-th zone is the region enclosed between the 2 ellipsoids giving path-length differences $n(\lambda/2)$ and $(n-1)(\lambda/2)$
- The 1st Fresnel zone corresponds to $n = 1$

Okumura-Hata model

Microwave transmission gain up to the radio horizon:

$$G_{avg} = Kd^{-n}$$

K, n – constants

Typically: $3 \leq n \leq 5$

$n = 2$: free space

$n = 4$: two-ray model

The best results – when the constants are determined experimentally for a given environment

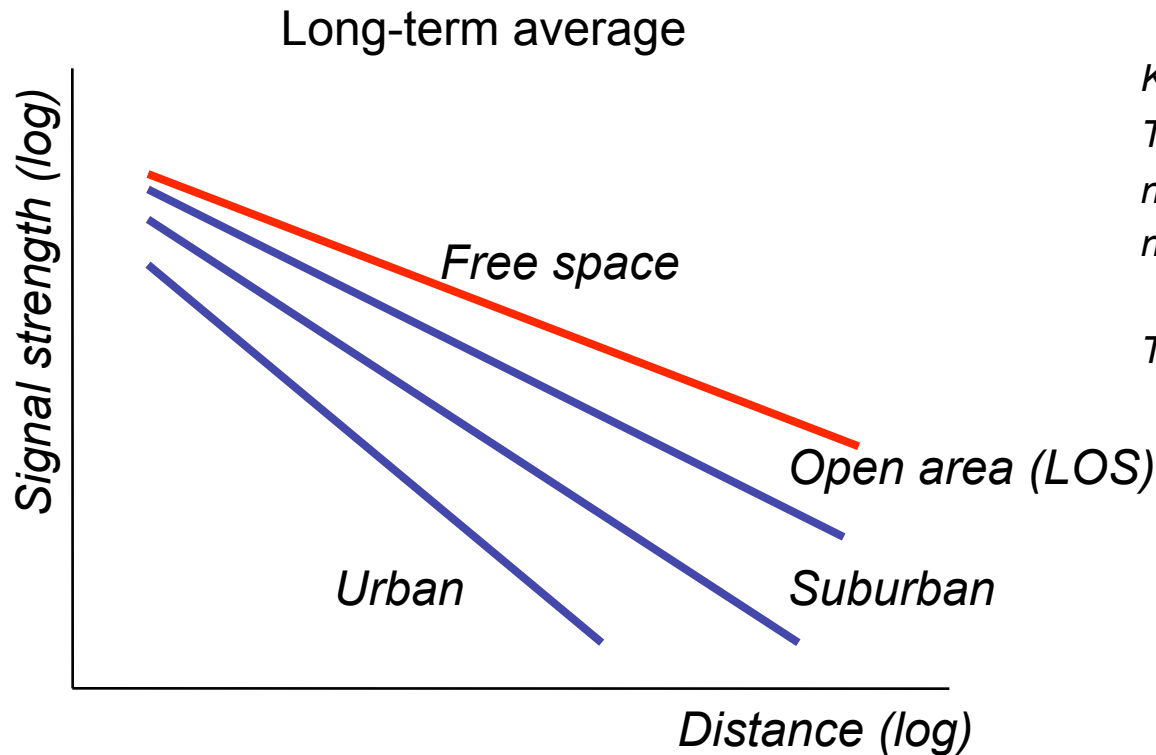

- MAPL = Max. Allowable Path Loss

$$\text{MAPL}_{\text{dB}} = P_{T\text{max(dB)}} - P_{R\text{min(dB)}}$$

- Max range:

$$P_R \cong P_T G_T G_R \left(\frac{\lambda}{4\pi d} \right)^n$$

$$(d)^n \cong \frac{P_T}{P_R} G_T G_R \left(\frac{\lambda}{4\pi} \right)^n$$

MAPL & max range

n	P_{TdBm}	P_{RdBm}	MAPL dB	2.4 GHz range m	5 GHz range m
2	0	-80	80	100	45
2	+20	-80	100	1000	450
4	0	-80	80	6	4
4	+20	-80	100	32	21

Power budget example

<i>Parameters</i>	<i>To access Peer to peer at different data rate point</i>			
	<i>11 Mbps</i>	<i>5.5 Mbps</i>	<i>2 Mbps</i>	<i>1 Mbps</i>
Frequency (GHz)	2.45	2.45	2.45	2.45
Transmit power (W)	0.020	0.020	0.020	0.020
Transmit power (dBW)	16.9	16.9	16.9	16.9
Transmit antenna gain (dBi)	2.0	2.0	2.0	2.0
Polarization loss (dB)	3.0	3.0	3.0	3.0
EIRP (dBW)	21.9	21.9	21.9	21.9
Range (m)	25.1	37.3	60.6	90.1
Path loss exponent (dB)	3.5	3.5	3.5	3.5
Free-space path loss (dB)	84.7	90.7	98.1	104.1
Rec. antenna gain (dBi)	2.0	2.0	2.0	2.0
Cable loss (dB)	1.9	1.9	1.9	1.9
Rake equalizer gain (dB)	0.5	0.5	0.5	0.5
Diversity gain (dB)	5.5	5.5	5.5	5.5
Receiver noise figure (dB)	13.6	13.6	13.6	13.6
Data rate (Kbps)	11000	5500	2000	1000
Required Eb/No (dB)	8.0	5.0	2.0	1.0
Rayleigh fading (dB)	7.5	7.5	7.5	7.5
Receiver sensitivity (dBm)	80.1	86.1	93.5	99.5
Signal-to-noise ratio (dB)	8.0	5.0	2.0	1.0
Link margin (dB)	0.0	0.0	0.0	0.0

Source: D. Liu et al.: Developing integrated antenna subsystems for laptop computers; IBM J. RES. & DEV. VOL. 47 NO. 2/3 MARCH/MAY 2003 p. 355-367

Non-LOS propagation

- – when the 1st Fresnel zone is obstructed and/ or the signal reached the receiver due to reflection, refraction, diffraction, scattering, etc.
 - An obstruction may lie to the side, above, or below the path.
 - » Examples: buildings, trees, bridges, cliffs, etc.
 - » Obstructions that do not enter in the 1st Fresnel zone can be ignored. Often one ignores obstructions up to $\frac{1}{2}$ of the zone

Quiz

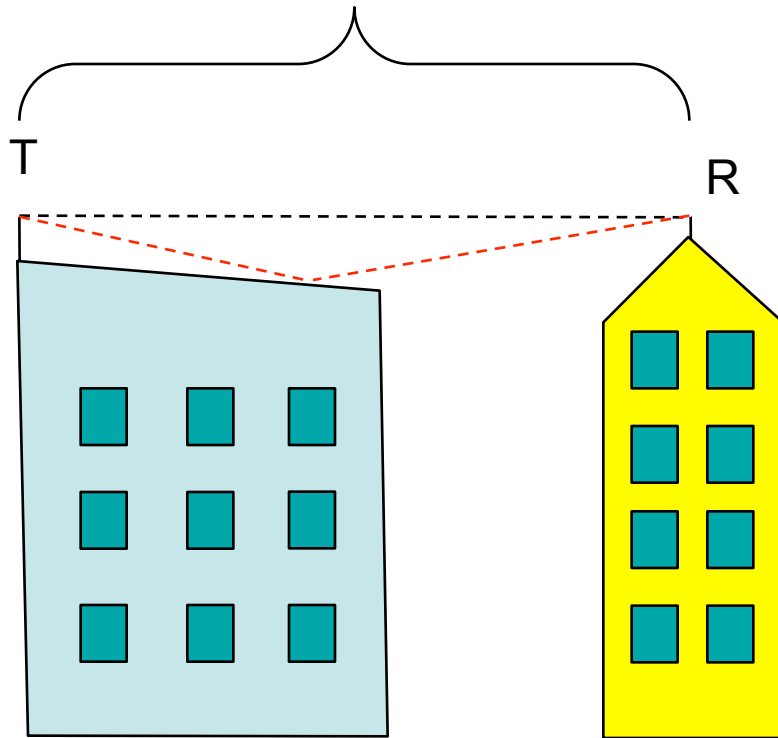

- A LOS link shown in the figure was designed with positive link budget. After deployment, no signal was received
- Why?

Reflection

Reflection: what it does?

- Changes the direction, magnitude, phase and polarization of the incident wave
 - Depending on the reflection coefficient, wave polarization, and shape of the interface
- Reflection may be specular (*i.e.*, mirror-like) or diffuse (*i.e.*, not retaining the image, only the energy) according to the nature of the interface.
- [Demonstration \(laser pointer\)](#)

- **Boundary conditions**
 - Tangential components of E (and H) at both sides of the border are equal to each other
 - With ideal conductor, tangential component of E is zero at the border

Reflection coefficient

- = The ratio of the complex amplitudes of the reflected wave and the incident wave

$$R_{HP} = \frac{\sin\psi - \sqrt{\epsilon_c - \cos^2\psi}}{\sin\psi + \sqrt{\epsilon_c - \cos^2\psi}}$$

$$R_{VP} = \frac{\epsilon_c \sin\psi - \sqrt{\epsilon_c - \cos^2\psi}}{\epsilon_c \sin\psi + \sqrt{\epsilon_c - \cos^2\psi}}$$

$\epsilon_c = \epsilon_r - j60\sigma\lambda$ (complex dielectric const.)

ψ : grazing angle (complementary angle of incidence)

ϵ_r : dielectric const. of reflection surface

σ : conductivity of reflection surface, 1/ohm.m

λ : wavelength, m

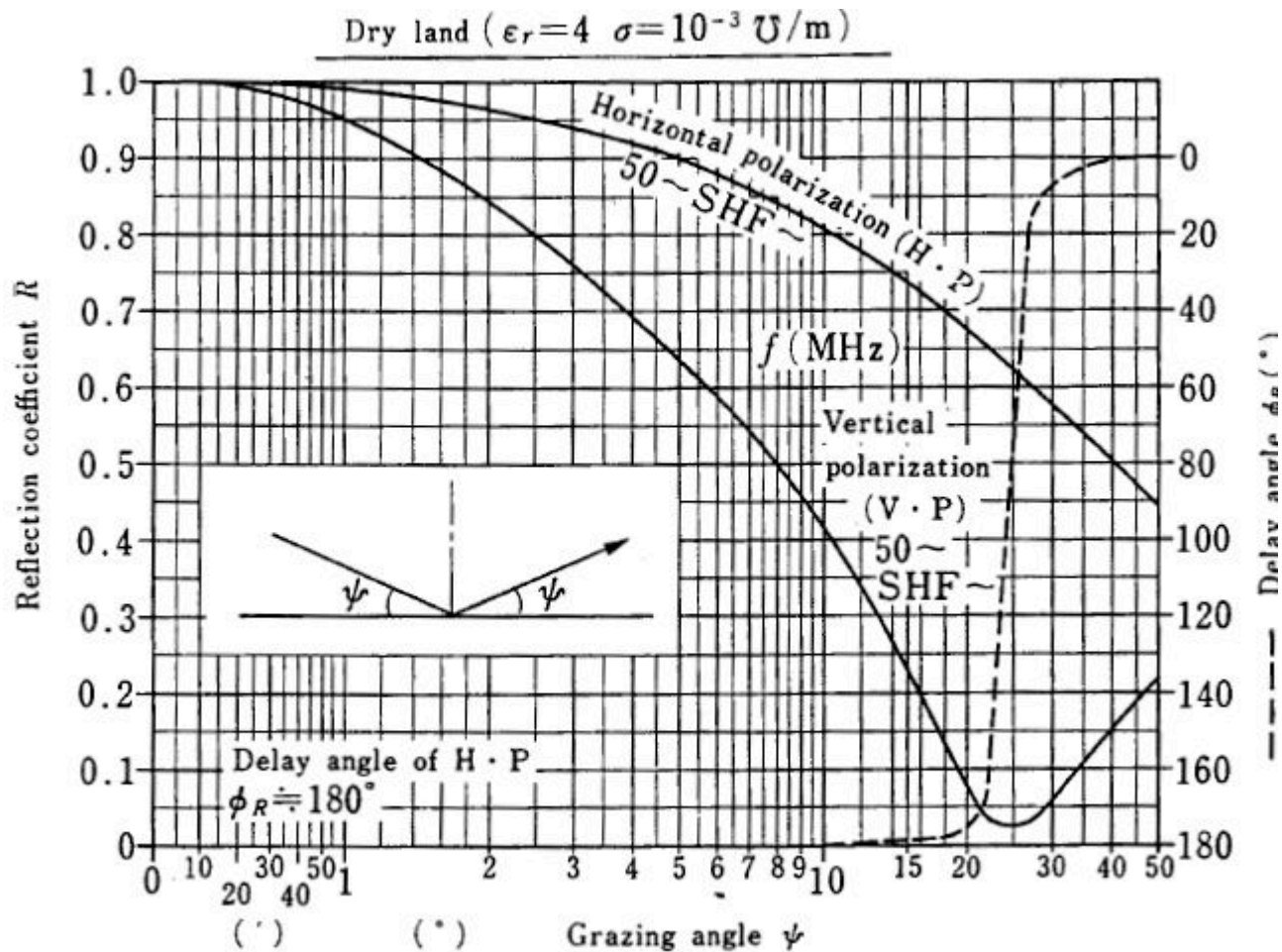

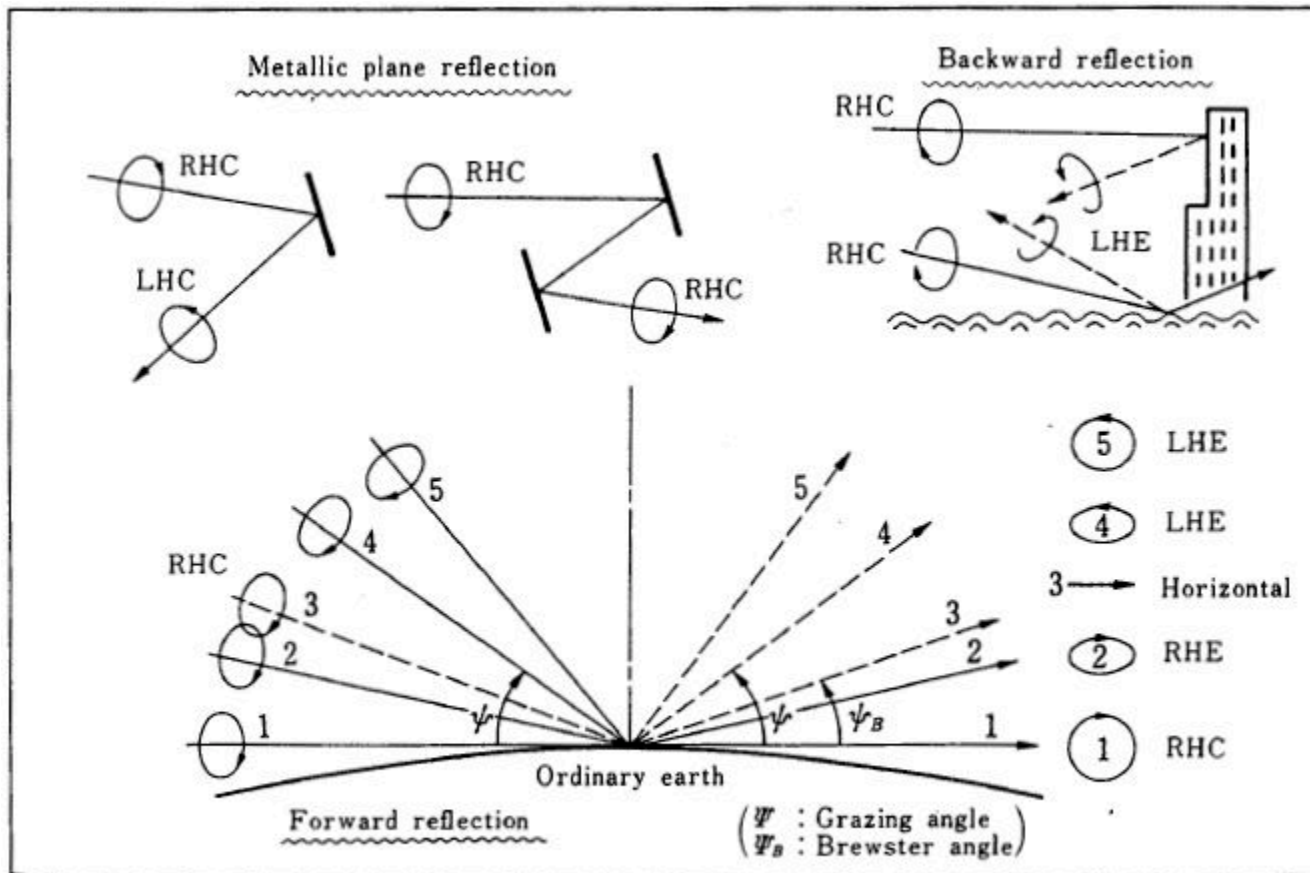

Note : RHC (Right-handed circular)
 LHC (Left-handed circular)

RHE (Right-handed elliptical)
 LHE (Left-handed elliptical)

2 ray propagation model

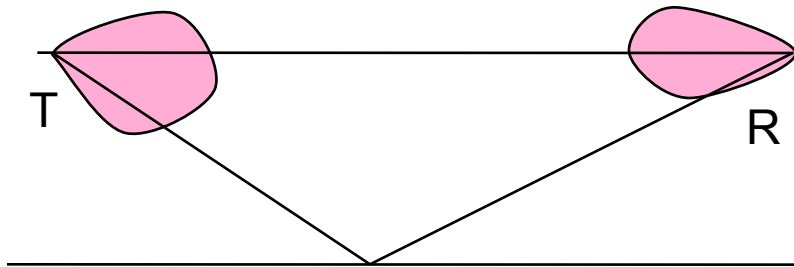

- The received direct and reflected waves differ due to
 - Path-lengths difference
 - Transmitting antenna (phase characteristics)
 - Receiving antenna (phase characteristics)
 - The antenna directive radiation pattern may have different magnitudes and phases for the direct ray and for the reflected ray

2 Rays: Path-length Difference

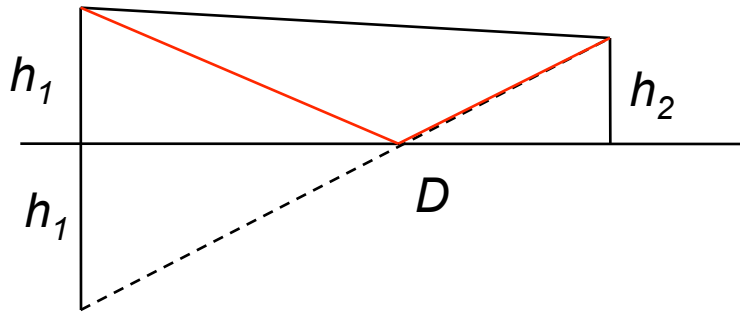

$$\text{Direct ray: } d_d = \sqrt{D^2 + (h_1 - h_2)^2} = D \sqrt{1 + \left(\frac{h_1 - h_2}{D}\right)^2} \approx D \left[1 + \frac{1}{2} \left(\frac{h_1 - h_2}{D}\right)^2 \right]$$

$$\text{Reflected ray: } d_r = \sqrt{D^2 + (h_1 + h_2)^2} = D \sqrt{1 + \left(\frac{h_1 + h_2}{D}\right)^2} \approx D \left[1 + \frac{1}{2} \left(\frac{h_1 + h_2}{D}\right)^2 \right]$$

$$\sqrt{(1+x)} = 1 + \frac{1}{2}x - \frac{1}{2} \frac{1}{4}x^2 + \frac{1}{2} \frac{1}{4} \frac{3}{6}x^3 - \dots \approx 1 + \frac{1}{2}x, \quad \text{if } x = 1$$

$$\Delta = d_r - d_d \approx \frac{(h_1 + h_2)^2}{2D} - \frac{(h_1 - h_2)^2}{2D} = \frac{h_1^2 + 2h_2h_1 + h_2^2 - h_1^2 + 2h_2h_1 - h_2^2}{2D} = \frac{2h_1h_2}{D}$$

Quiz

- At what distance difference the phase of the direct ray differ from that of the reflected ray by 180 deg at
 - 3 MHz?
 - 300 MHz?
 - 3 GHz?

2 rays: resultant field strength

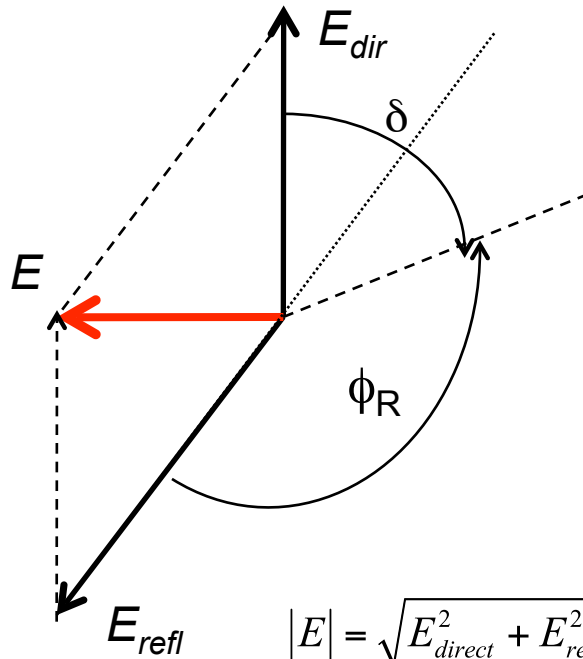

Plane TEM wave: $PF D = P_T / (4\pi D^2)$

$$E_0 = \sqrt{120\pi PF D} = \sqrt{30P_T} / D$$

$PF D$: free-space power flux density, W/m^2

P_T : power radiated (isotropic antenna), W

D : distance between antennas, m

E_0 : free space field strength (isotropic antenna), V/m

Note: With real antennas, use e.i.r.p. instead of P

$$|E| = \sqrt{E_{direct}^2 + E_{refl}^2 - 2E_{direct}E_{refl} \cos(\delta + \phi_R - \pi)} = E_{direct} \sqrt{1 + R^2 - 2R \cos(\delta + \phi_R - \pi)}$$

$$R = \left| \frac{E_{refl}}{E_{direct}} \right| e^{-j\phi_R}; \quad \delta = 2\pi\Delta/\lambda \quad (= \text{lagging angle due to path-length difference})$$

$\Delta =$ length difference = (reflected path) - (direct path)

$$\delta \rightarrow 4\pi h_1 h_2 / \lambda D, \text{ if } D / (h_1 + h_2) \rightarrow \infty$$

2-ray model: max signal

$$E = E_{direct} \sqrt{1 + R^2 - 2R \cos(\delta + \phi_R - \pi)}$$

$$\max \text{ if } \cos(\delta + \phi_R - \pi) = -1$$

$$E_{\max} = E_{direct} \sqrt{1 + R^2 + 2R} = E_{direct} (1 + R)$$

$$\cos(.) = -1 \text{ if } (\delta + \phi_R - \pi) = \pi, 3\pi, \dots, (2k + 1)\pi$$

$$\delta = 2k\pi - \phi_R$$

substituting for δ , we have

$$\frac{4\pi h_1 h_2}{\lambda D} \approx 2k\pi - \phi_R$$

$$\text{if } \phi_R = 0, \text{ then } \frac{2h_1 h_2}{\lambda D} \approx k$$

2-ray model: min signal

min if $\cos(\delta + \phi_R - \pi) = 1$

$$E_{\min} = E_{\text{direct}} \sqrt{1 + R^2 - 2R} = E_{\text{direct}} (1 - R)$$

$$(\delta + \phi_R - \pi) = 0, 2\pi, \dots, 2k\pi$$

$$\delta = (2k + 1)\pi - \phi_R$$

substituting for δ , we have

$$\frac{4\pi h_1 h_2}{\lambda D} \approx (2k + 1)\pi - \phi_R$$

$$\text{if } \phi_R = 0, \text{ then } \frac{4h_1 h_2}{\lambda D} \approx (2k + 1)$$

2 rays: $R \cong -1$

$$\frac{E}{E_{direct}} = \sqrt{2(1 - \cos \delta)} = 2 \sin \frac{\delta}{2}$$

$$\frac{E}{E_{direct}} = 2 \sin \frac{2\pi h_1 h_2}{\lambda D}$$

$$\sin x = x - \frac{x^3}{3!} + \frac{x^5}{5!} - \dots$$

$$\frac{E}{E_{direct}} \approx \frac{4\pi h_1 h_2}{\lambda D} \quad \text{if} \quad \frac{2\pi h_1 h_2}{\lambda D} = 1$$

Distance Dependence

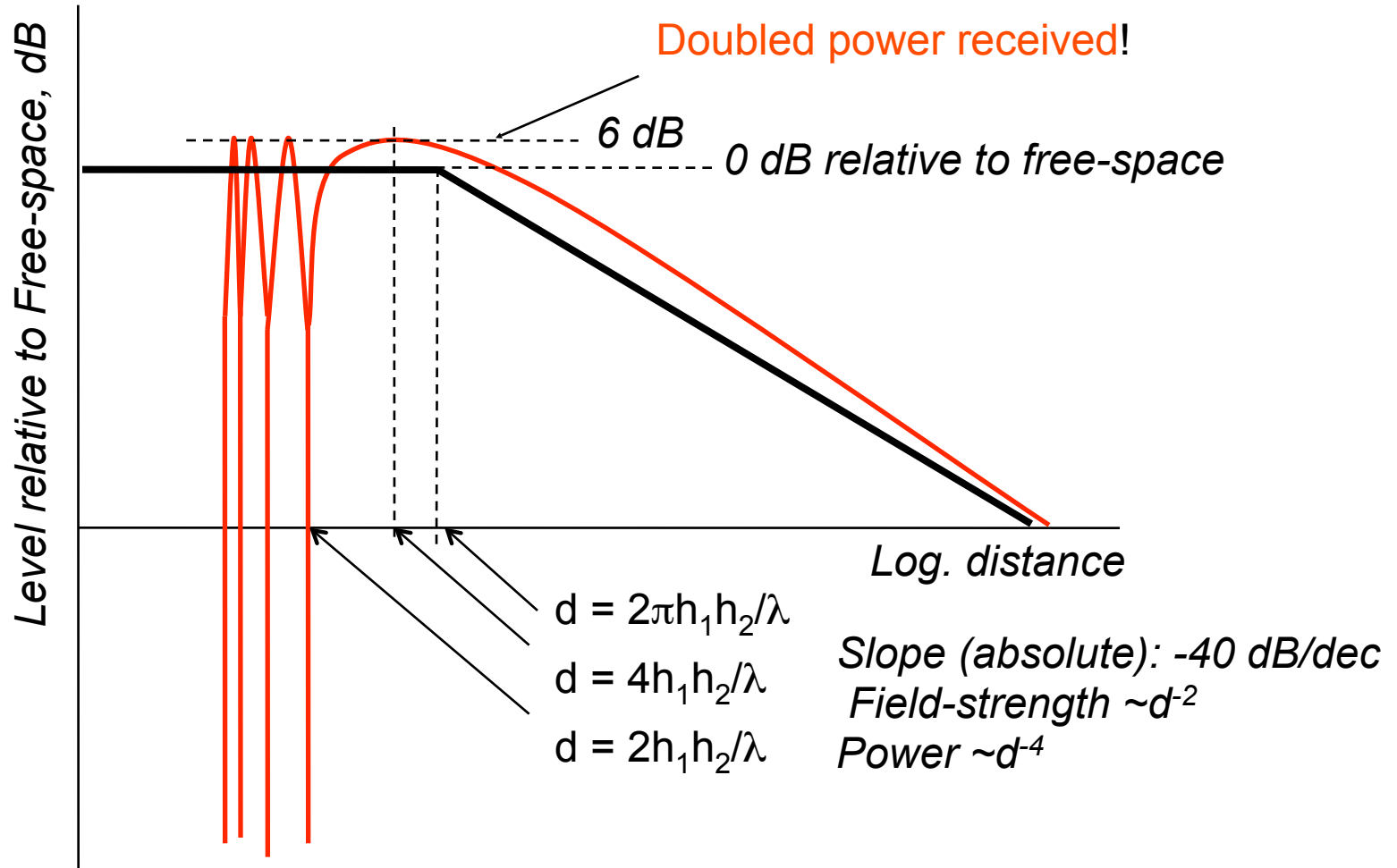

Simulated Experiments

- Distance dependence
- Height dependence
- Frequency dependence

Example 1: distance

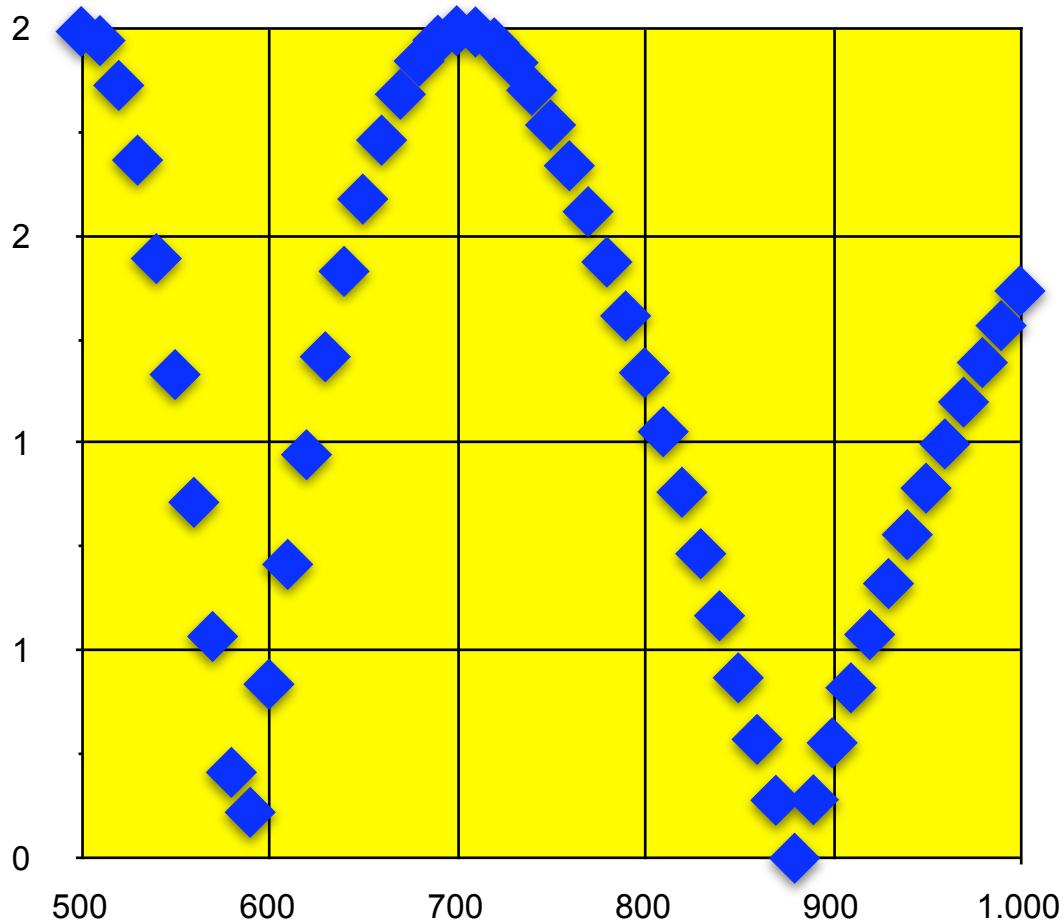

Variable:
 $d = 500-1000\text{m}$
Step = 10m

Fixed parameters:
 $F = 2.4 \text{ GHz}$
 $H1 = 11\text{m}$
 $H2 = 10\text{m}$
 $|R| = 1$
 $\text{Arg}(R) = 180^\circ$

Example 2: height

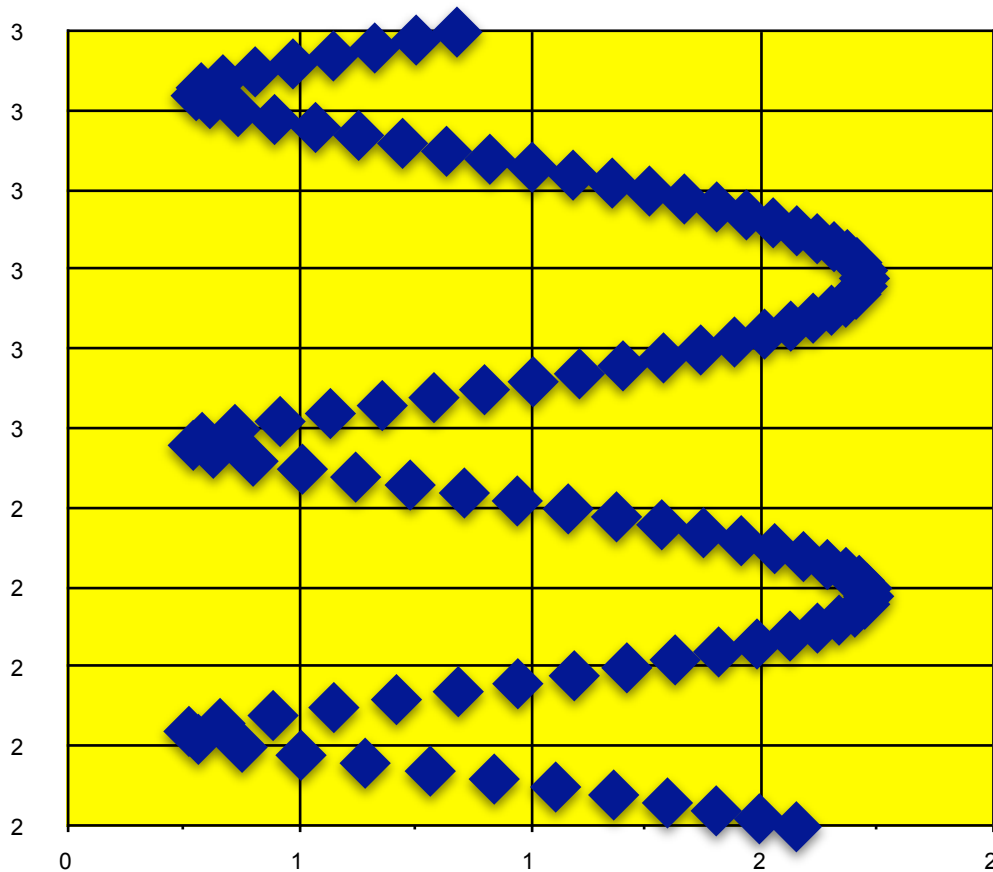

Property of R. Struzak

Variable:

$$H2 = 2 - 3\text{m}$$

$$\text{Step} = 1\text{ cm}$$

Fixed

parameters:

$$F = 2.4\text{GHz}$$

$$H1 = 1\text{m}$$

$$D = 3\text{m}$$

$$|R| = 1$$

$$\text{Arg}(R) = 180^\circ$$

Example 3: frequency

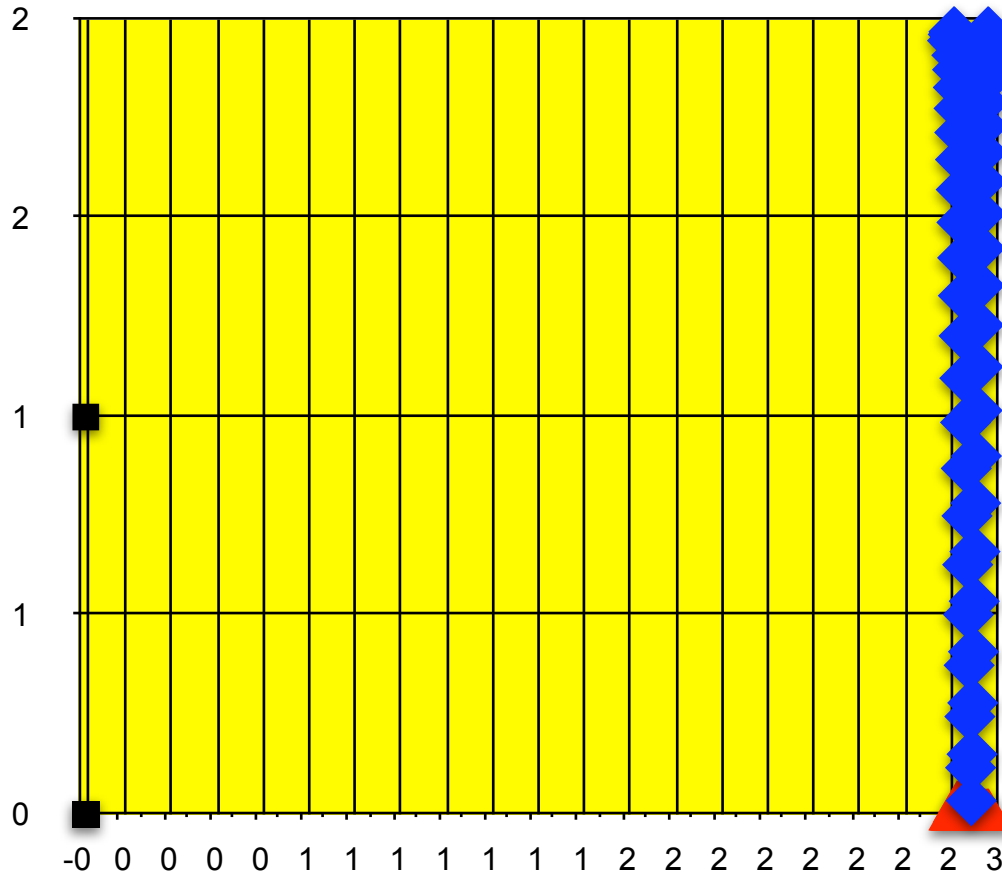

Variable:

$F = 2.4 - 2.6$
GHz Step = 2
MHz

Fixed

parameters:

$H1 = 14$ m

$H2 = 12$ m

$D = 104$ m

$|R| = 1$

$\text{Arg}(R) = 180^\circ$

Quiz

- What precision of antenna location (ΔD , Δh) is required to assure $|E/E_{\text{direct}}| < 3$ dB (assuming 2-rays propagation model) at frequency
 - 30 MHz?
 - 300 MHz?
 - 3 GHz?

Field-strength measurements



- The field strength strongly depends on local environment
- Measurement results depend on the antenna location/ orientation, local cables, etc.
- Measurement uncertainty can be reduced by statistical evaluation of many measurements at slightly changed antenna positions

Avoiding negative reflection effects

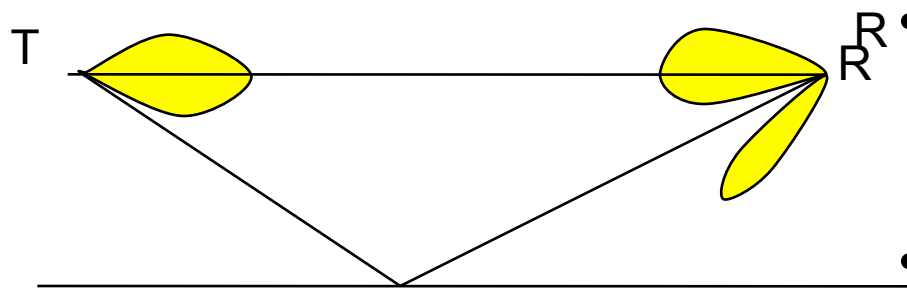

- Controlling the directive antenna gain at the transmitter and/or receiver

- Blocking the reflected ray at the transmitter-reflector path and/or reflector – receiver path

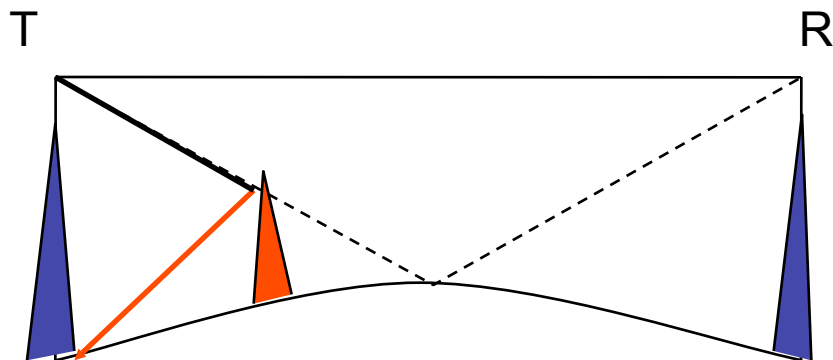

- Combine constructively the signals using correlation-type receiver

- Antenna diversity (~10 dB)
- Dual antennas placed at $\lambda/2$ separation

Absorbing reflections



- Absorbing the reflected wave
- Covering reflecting objects by absorbing material (Black-body in optics)

Passive relaying

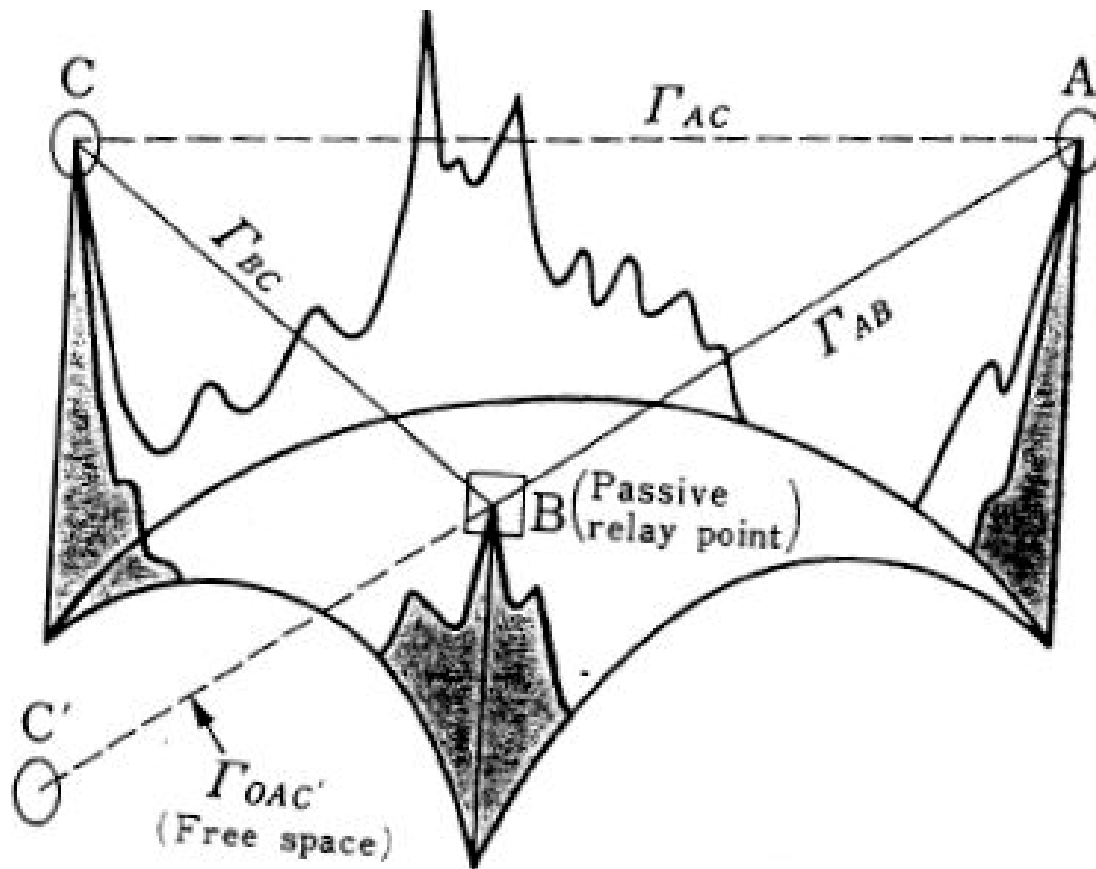

Multipath

Multipath propagation

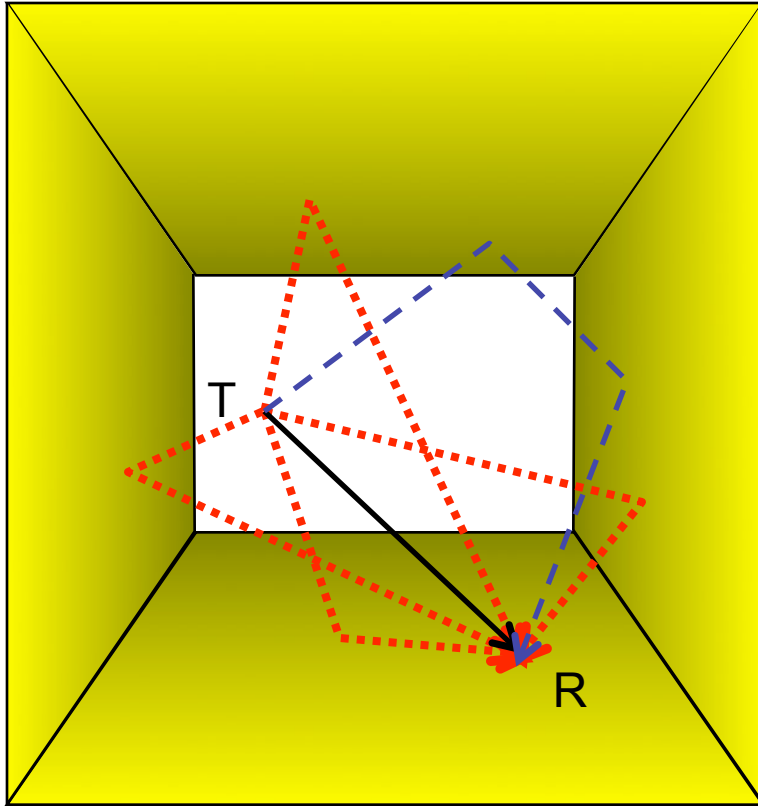

Indoor

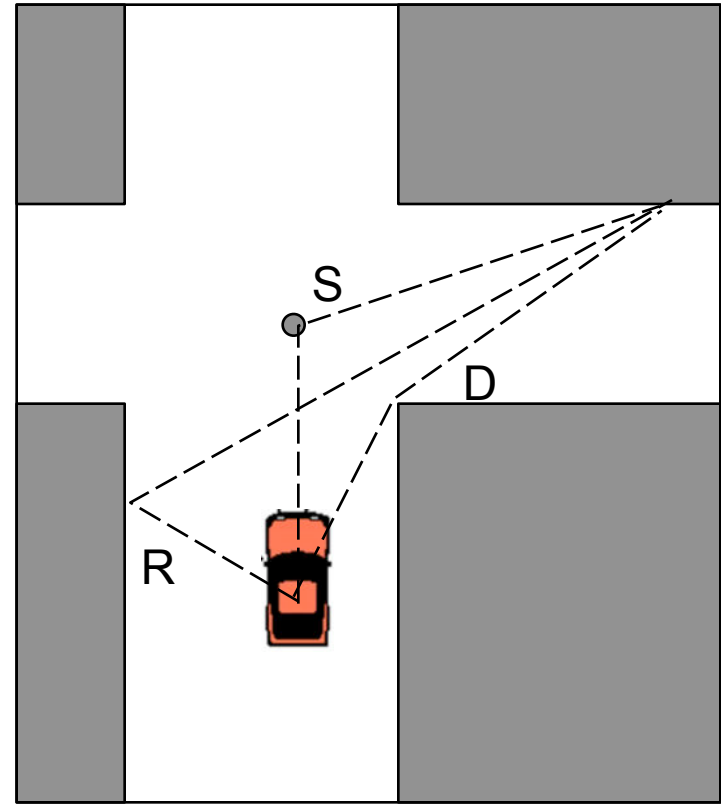

Outdoor: reflection (R),
diffraction (D), scattering (S)

- The effects of multipath include constructive and destructive interference, and phase shifting of the signal. This causes *Rayleigh fading*, with standard statistical distribution known as the *Rayleigh distribution*.
- Rayleigh fading with a strong line of sight content is said to have a *Rician distribution*, or to be *Rician fading*.
 - » http://en.wikipedia.org/wiki/Rayleigh_fading; http://en.wikipedia.org/wiki/Lord_Rayleigh;

Time – Frequency Characteristics

- Radio channel can be treated as a linear two-terminal-pair transmission channel (input port: transmitting antenna; output port: receiving antenna).

$$Y(\omega) = X(\omega)H(\omega)$$

$$y(t) = \int_{-\infty}^{\infty} x(t)h(t-\tau)d\tau = x(t) \otimes h(t)$$

$$H(\omega) = \int_{-\infty}^{\infty} h(t)e^{-j\omega t} dt \text{ (frequency transfer function of the channel)}$$

$$h(t) = \frac{1}{2\pi} \int_{-\infty}^{\infty} H(\omega)e^{j\omega t} d\omega \text{ (impulse response of the channel)}$$

$$\omega = 2\pi f$$

$x(t)$, $X(\omega)$: input signal time and spectral representation

$y(t)$, $Y(\omega)$: output signal time and spectral representation

Direct RF Pulse Sounding

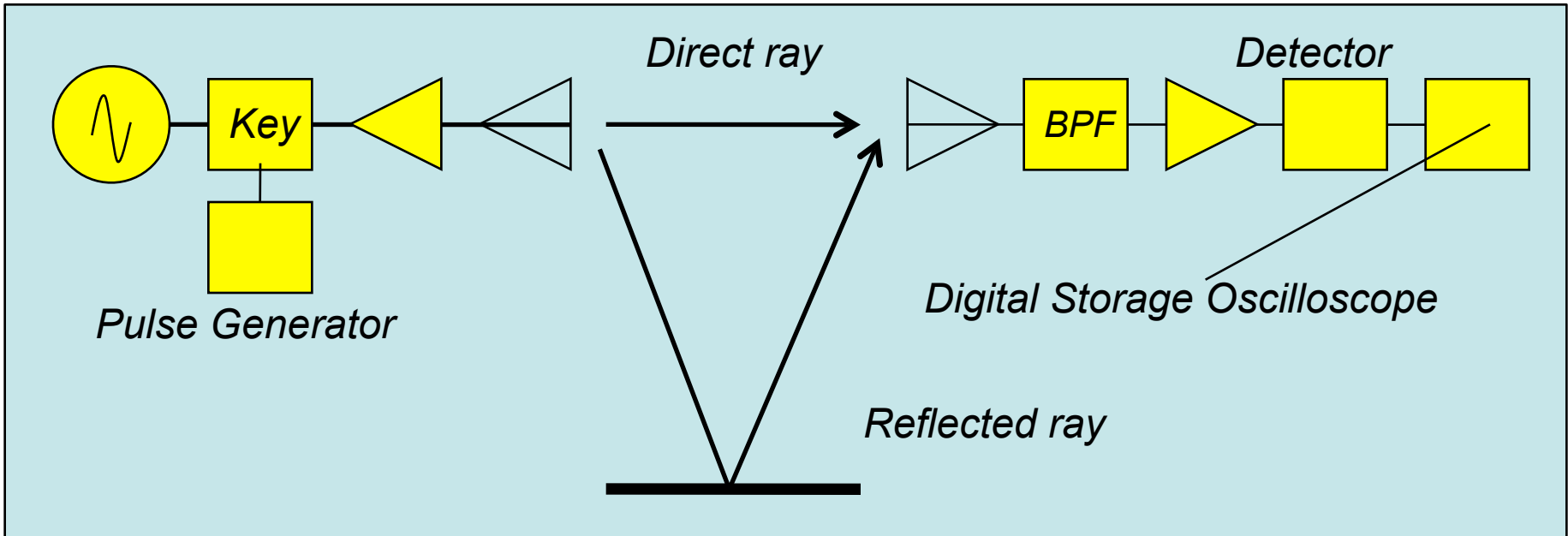

Frequency Domain Sounding

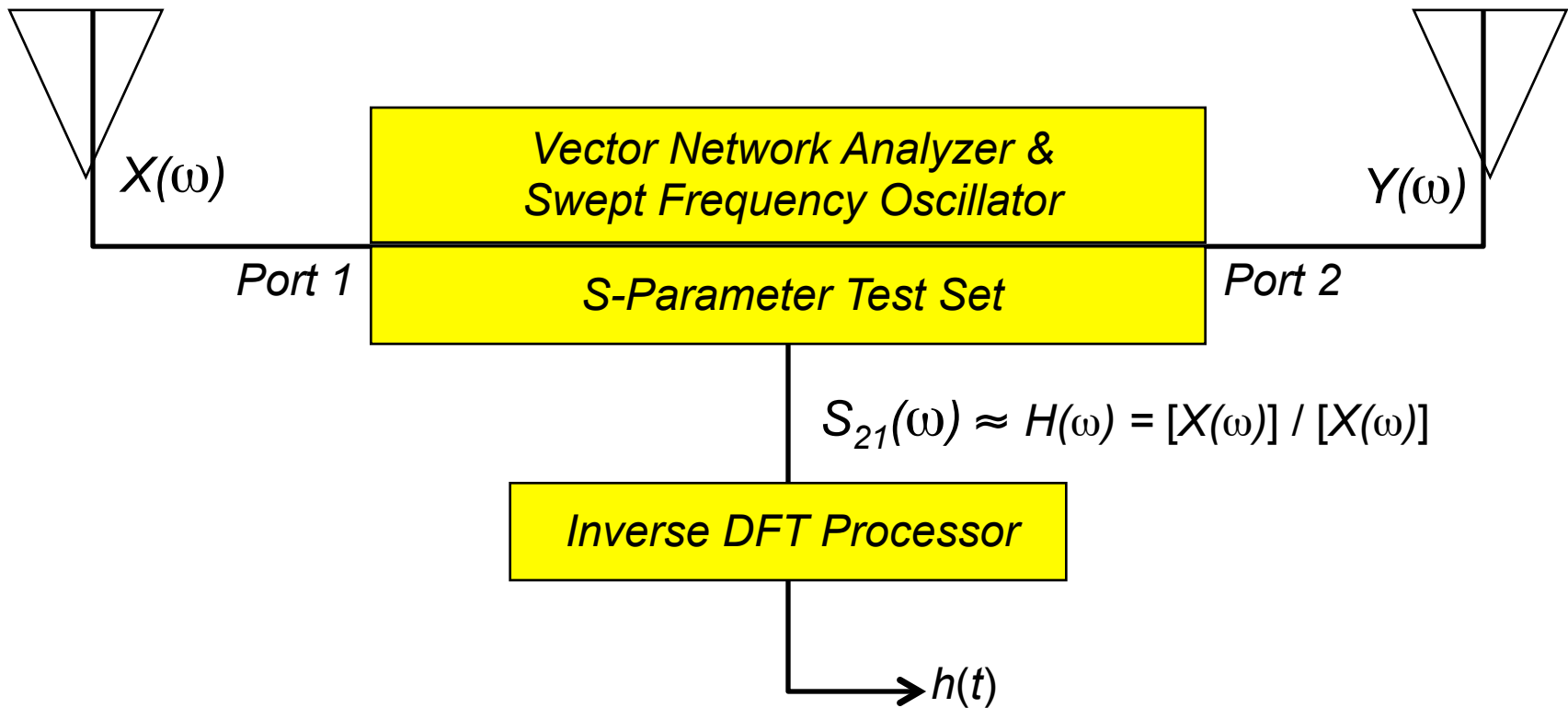

$$h(t) = \text{Inverse Fourier Transform of } H(\omega)$$

Time Response, 2 Rays

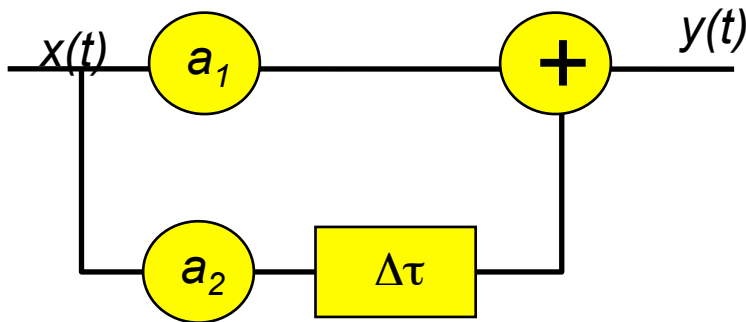
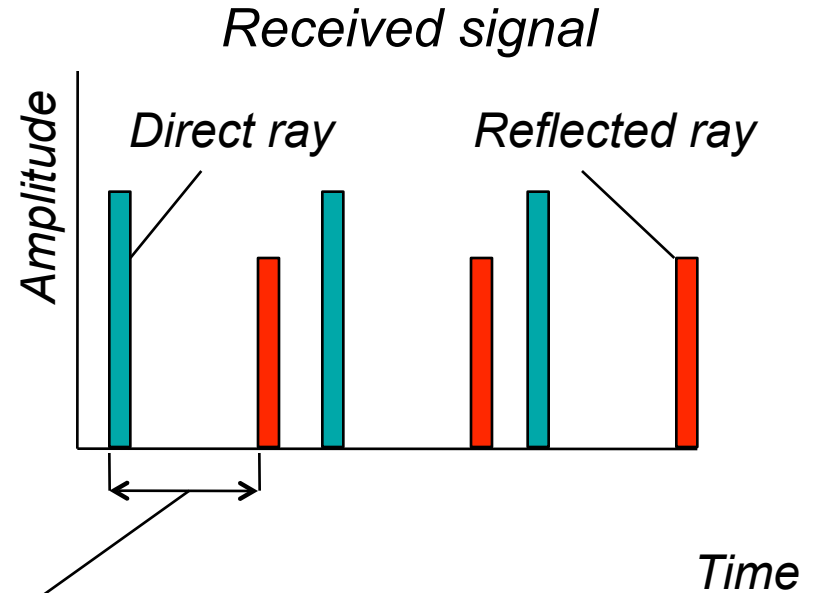
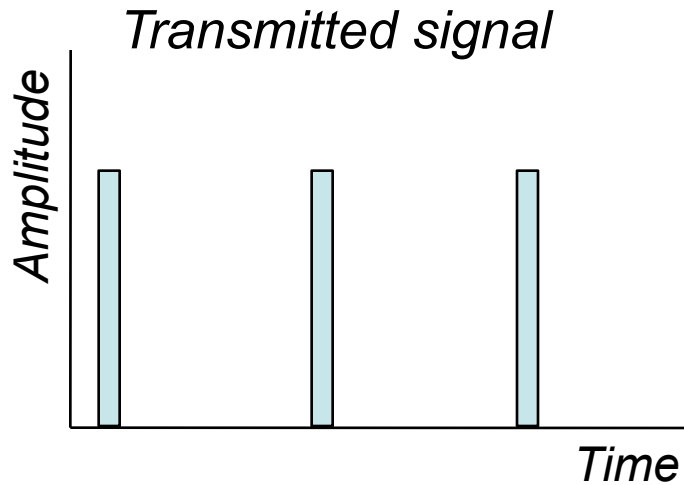

$$\Delta\tau = c(d_{\text{reflect}} - d_{\text{direct}})$$

Light velocity
Path-length difference

Power Delay Profile

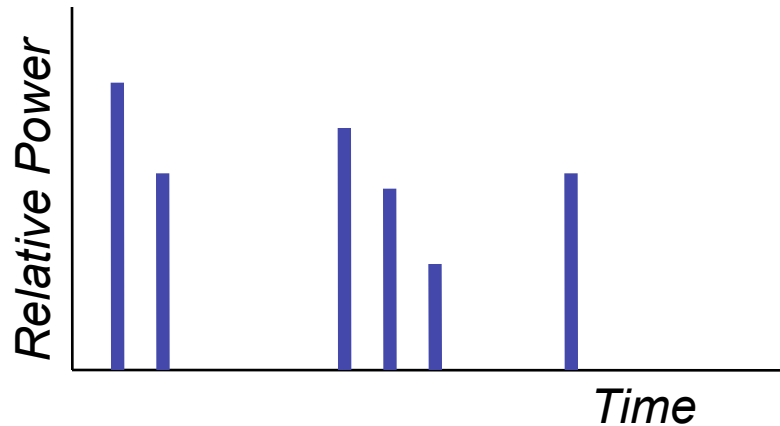

$$\tau_{aver} = \frac{\sum_{k=1}^N \tau_k \alpha_k^2}{\sum_{k=1}^N \alpha_k^2}$$

$$\tau_{rms} = \sqrt{\frac{\sum_{k=1}^N (\tau_k - \tau_{aver})^2 \alpha_k^2}{\sum_{k=1}^N \alpha_k^2}}$$

- If an impulse is sent from transmitter in a multiple-reflection environment, the received signal will consist of a number of impulse responses whose delays and amplitudes depend on the reflecting environment of the radio link. The time span they occupy is known as delay spread
- The dispersion of the channel is normally characterized using the RMS Delay Spread, or standard deviation of the power delay profile

Inter-symbol Interference

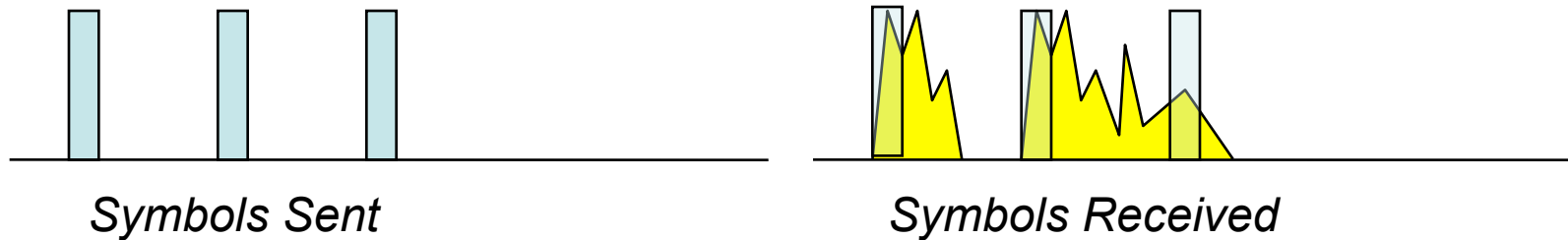

- The delay spread limits the maximum data rate: no new impulse should reach the receiver before the last replica of the previous impulse has perished.
- Otherwise the symbol spreads into its adjacent symbol slot, the two symbols mix, the receiver decision-logic circuitry cannot decide which of the symbols has arrived, and inter-symbol interference occurs.

Error Bursts

- When the delay spread becomes a substantial fraction of the bit period, error bursts may happen.
- These error bursts are known as irreducible since it is not possible to reduce their value by increasing the transmitter power.

Error Reduction

- Elimination of reflections as discussed earlier, plus
- Applying error-resistant modulations, codes, and communication protocols
- Applying Automatic Repeat Request (ARQ)
 - Retransmission protocol for blocks in error

Microcell vs. Macrocell

	Microcell	Macrocell
Cell radius	0.1-1 km	1-20 km
Tx power	0.1-1 W	1-10 W
Fading	Ricean	Rayleigh
RMS delay spread	10-100 ns	0.1-10 μ s
Bit Rate	1 Mbps	0.3 Mbps

After R.H.Katz CS294-7/1996

Propagation effects

Troposphere

- = the lower layer of atmosphere (between the earth surface and the stratosphere) in which the change of temperature with height is relatively large. It is the region where convection is active and clouds form.
- Contains ~80% of the total air mass. Its thickness varies with season and latitude. It is usually 16 km to 18 km thick over tropical regions, and less than 10 km thick over the poles.

Troposphere effects (clear air)

- absorption by atmospheric gases
 - molecular absorption by water vapor and O₂
 - important bands at ~22 and ~60 GHz
- refractive effects
 - ray bending
 - super-refraction and ducting
 - multipath
 - Scintillation
 - » scintillation: a small random fluctuation of the received field strength about its mean value. Scintillation effects become more significant as the frequency of the propagating wave increases.

LOS – Radio Horizon

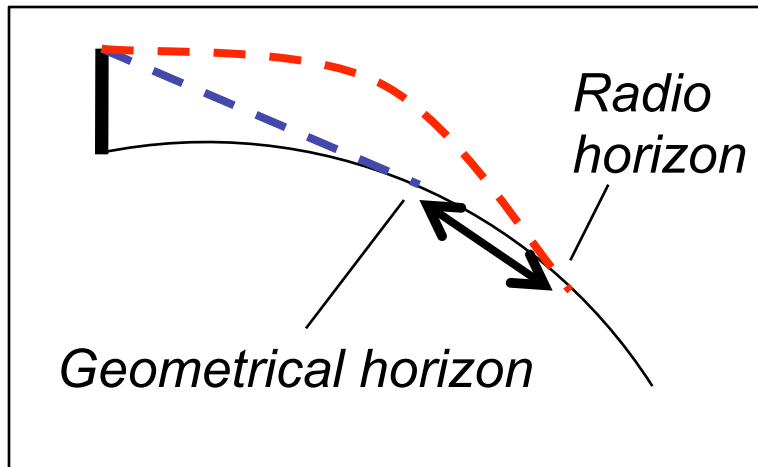
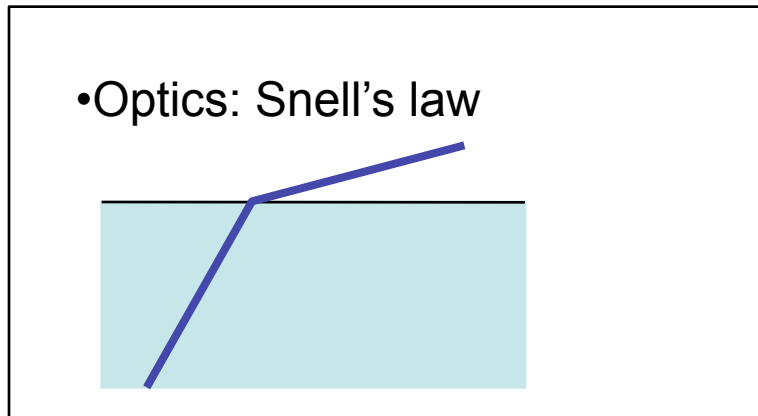

- *Earth curvature*
- *Radio waves go behind the geometrical horizon due to refraction: the air refractivity changes with height, water vapor contents, etc.*
- *In standard conditions the radio wave travels approximately along an arc bent slightly downward.*
- *K-factor is a scaling factor of the ray path curvature. $K=1$ means a straight line. For the standard atmosphere $K=4/3$. An equivalent Earth radius KR_{earth} 'makes' the path straight*
- *Departure from the standard conditions may lead to subrefraction, superrefraction or duct phenomena.*

Atmospheric Absorption

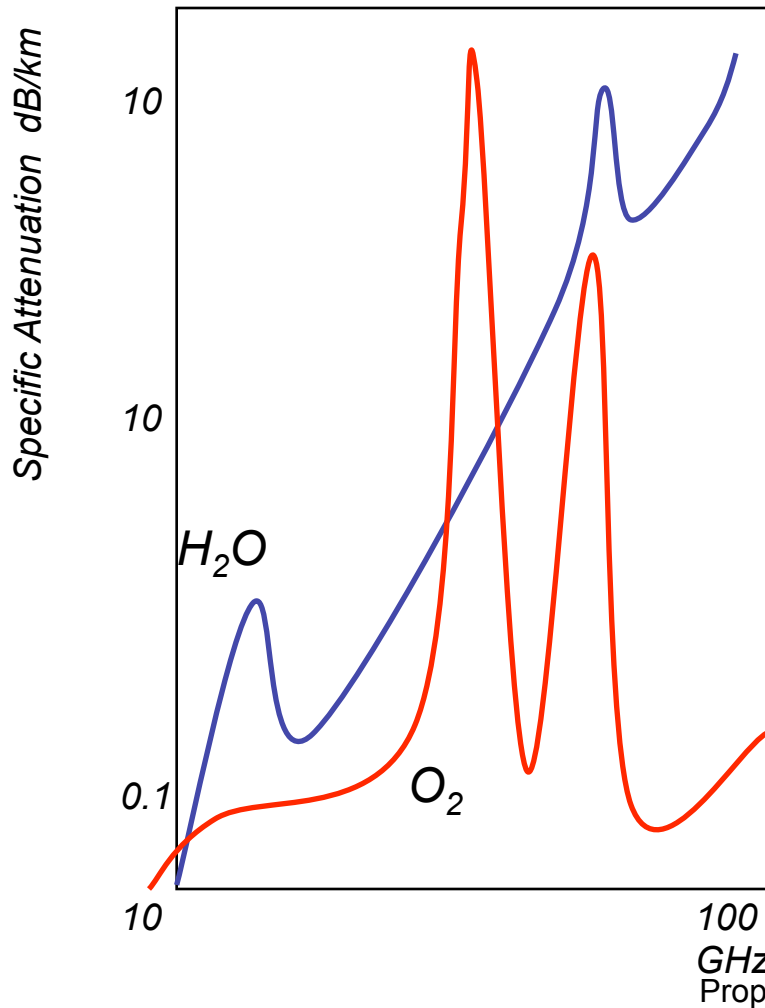

- Important at frequencies >10 GHz
- The atmosphere introduces attenuation due to interaction of radio wave at molecular/ atomic level
 - Exploited in Earth-exploration passive applications
 - New wideband short-distance systems

Ground and obstacles

- terrain (smooth Earth, hills and mountains)
 - diffraction, reflection and scattering
- buildings (outside and inside)
 - diffraction, reflection and scattering
- vegetation
 - attenuation
 - scattering

Obstacles & diffraction

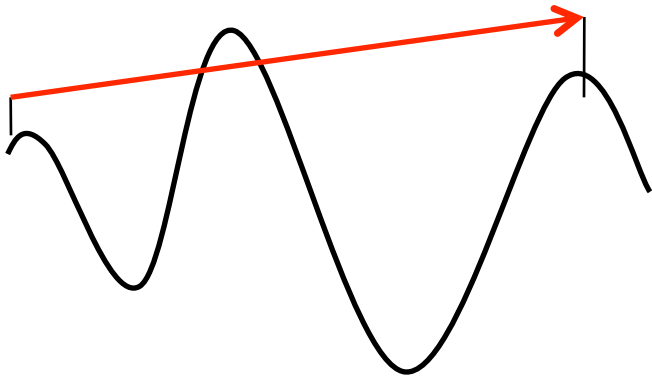

Obstacles such as a mountain range or edge of a building are often modeled as *knife-edge* obstacle

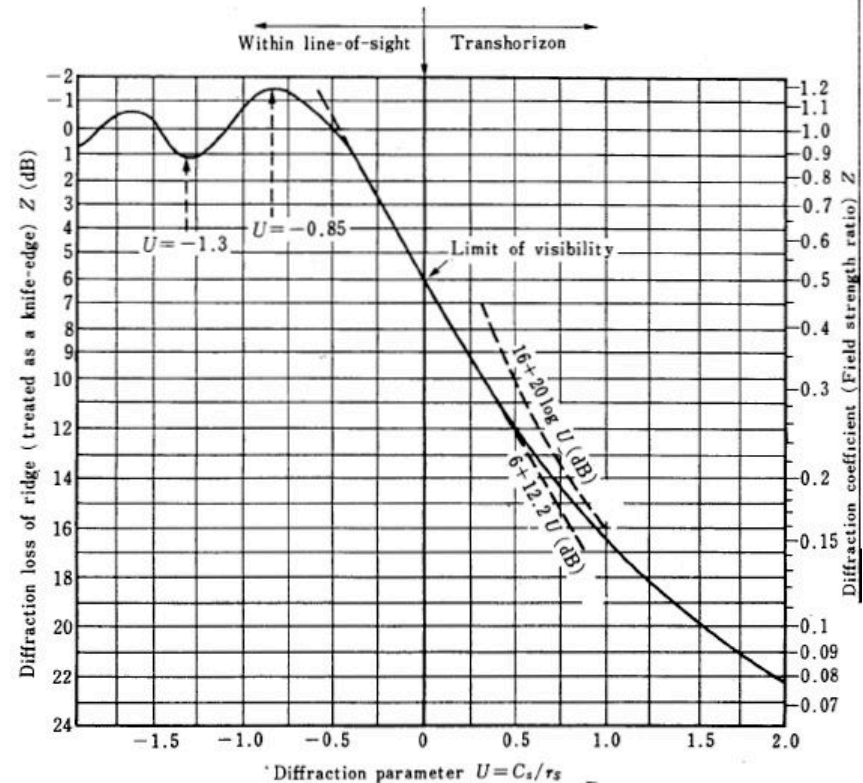
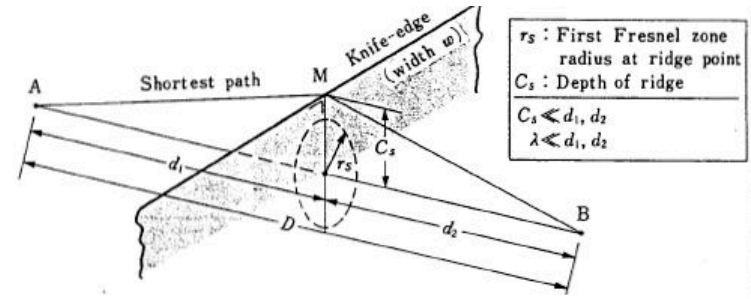

Huygens principle

- Dutch physicist and astronomer [Christiaan Huygens](#) (1629 - 1695) offered an explanation of [wave](#) propagation near obstacles ([diffraction](#)) in the [far field](#).
 - Each point of an advancing wave front acts as a source of secondary spherical waves. The advancing wave as a whole is the sum of all the secondary waves arising from points in the medium already traversed. When the wave front approaches an opening or barrier, only the wavelets approaching the unobstructed section can get past. They emit new wavelets in all directions, creating a new wave front, which creates new wavelets and new wave front, etc. - the process self-perpetuates.
 - Example: two rooms are connected by an open doorway and a sound is produced in a remote corner of one of them; in the other room the sound seems to originate at the doorway.

Effects of Buildings - inside

- Important for the planning of indoor LAN's and wireless private business exchanges for high data rate services
 - Reflection, multipath and diffraction from objects
 - delay spread 70 - 150 ns (~2 GHz; residential – commercial; compare with symbol length)
 - statistical or site-specific propagation models
 - Path loss through walls and floors
 - frequency re-use?
 - Channeling of energy along the building structures

Effects of Buildings - outside

- Important in the planning of short-range mobile and personal communication systems, LAN's and Wireless Local Loop systems
 - Wall/ roof attenuation if antennas located in the building
 - Line-of-sight path outside
 - Attenuation (free-space, atmospheric gases, rain, etc.)
 - Non line-of-sight path
 - reflection, diffraction and scatter
 - building height, density, street width, orientation
 - crossing streets, corner angle (street canyon)
 - Multipath delay spread e.g. 0.8 - 3 μ s (urban - suburban)

Troposphere effects (non-clear air)

- rain effects
 - attenuation
 - depolarization
 - scattering
- cloud effects
 - attenuation
- system availability considerations
 - 99.9 % availability (rain at 0.1 % time)
 - 90 % availability (cloud at 10 % time)

Effects of vegetation shadowing

Pine tree

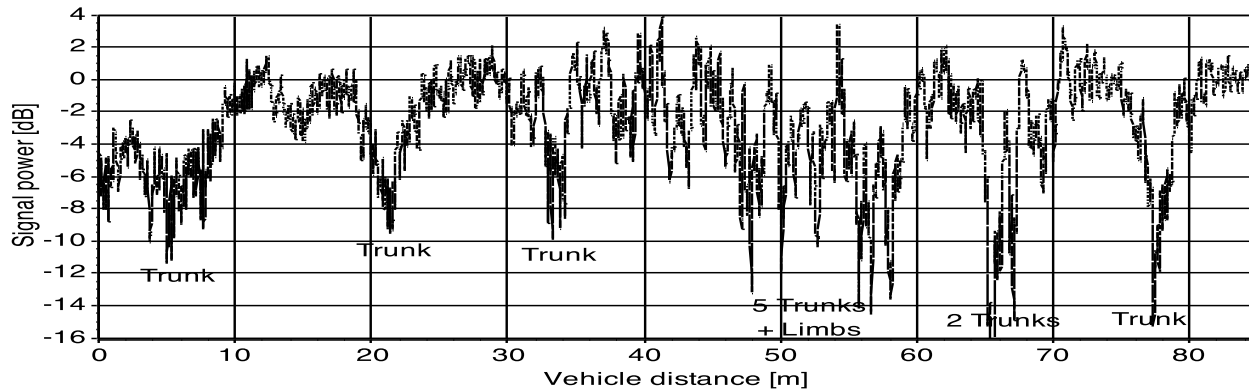

Attenuation
up to 20 dB

Depends on the
species of tree,
density and structure
of foliage, movement
of branches and
foliage, etc.

Palm tree

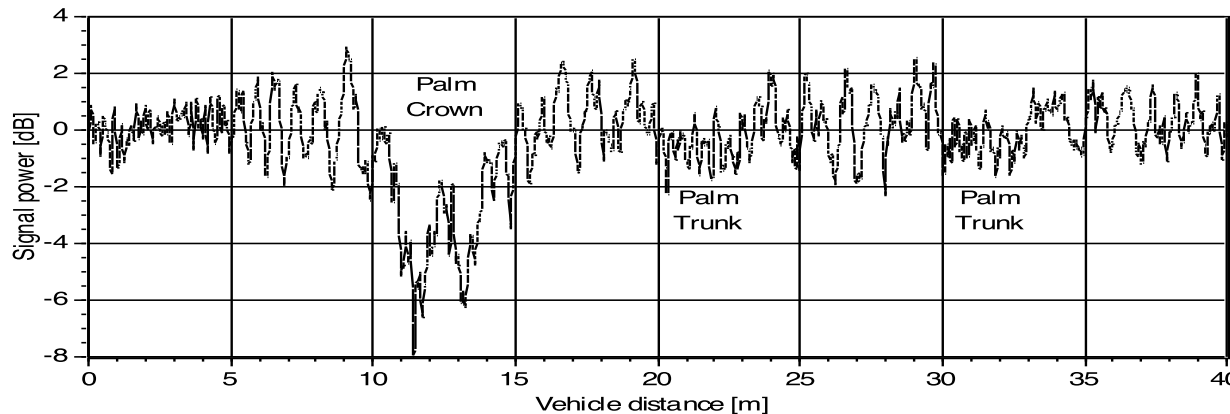

Important for the
planning of
microwave
propagation path
over wooded areas

Fading

- Case of more than one propagation path (mode) exists between T and R
- Fading = the result of variation (with time) of the amplitude or relative phase, or both, of one or more of the frequency components of the signal.
- Cause: changes in the characteristics of the propagation path with time.

- Variations

Shadowing: log-normal distribution

$$p(\overline{G}_s) = \frac{1}{\sigma_s \sqrt{2\pi}} \exp \left[-\frac{(\overline{G}_s - \overline{G}_{avg})^2}{2\sigma_s^2} \right]$$

$p(\overline{G}_s)$: probability density function

σ_s : standard deviation (8 – 12dB)

Multipath fading: Rayleigh, Rice,
and/or Nakagami-Rice distributions

Digital terrain model

SISP

- SISP – Site Specific propagation models based on an analysis of all possible rays between the transmitter and receiver to account for reflection, diffraction & scattering
- Requires exact data on the environment
 - Indoor: detailed 3D data on building, room, equipment
 - Outdoor: 3D data on irregular terrain infrastructure, streets, buildings, etc. (Fresnel-Kirchoff or Deygout theoretical constructions)
 - Large databases
 - Satellite/ aerial photographs or radar images,

Signal coverage map



- Example of computer-generated signal-level distribution superimposed on a terrain map
 - Light-blue = strong signal

DTM

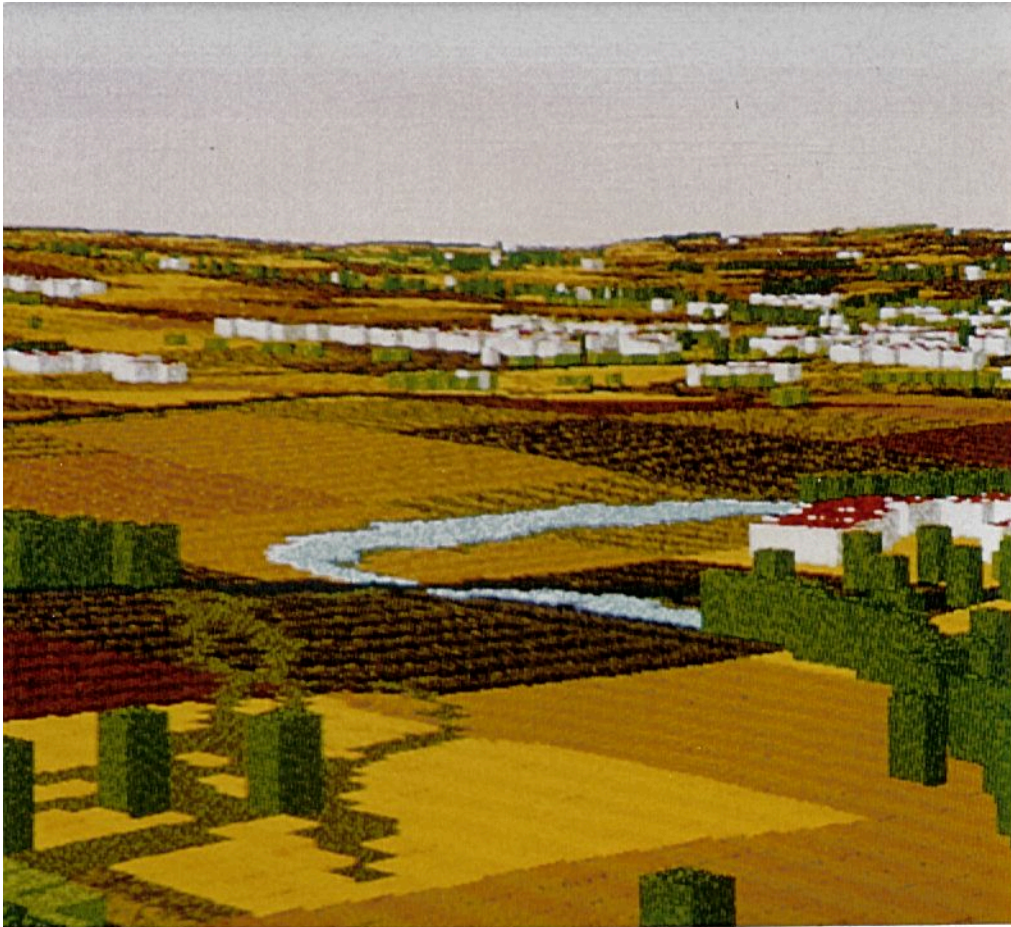

- Application of detailed propagation prediction models requires topographical information: Digital Terrain Model (DTM) or Digital Terrain Elevation Data (DTED)

DTM data base

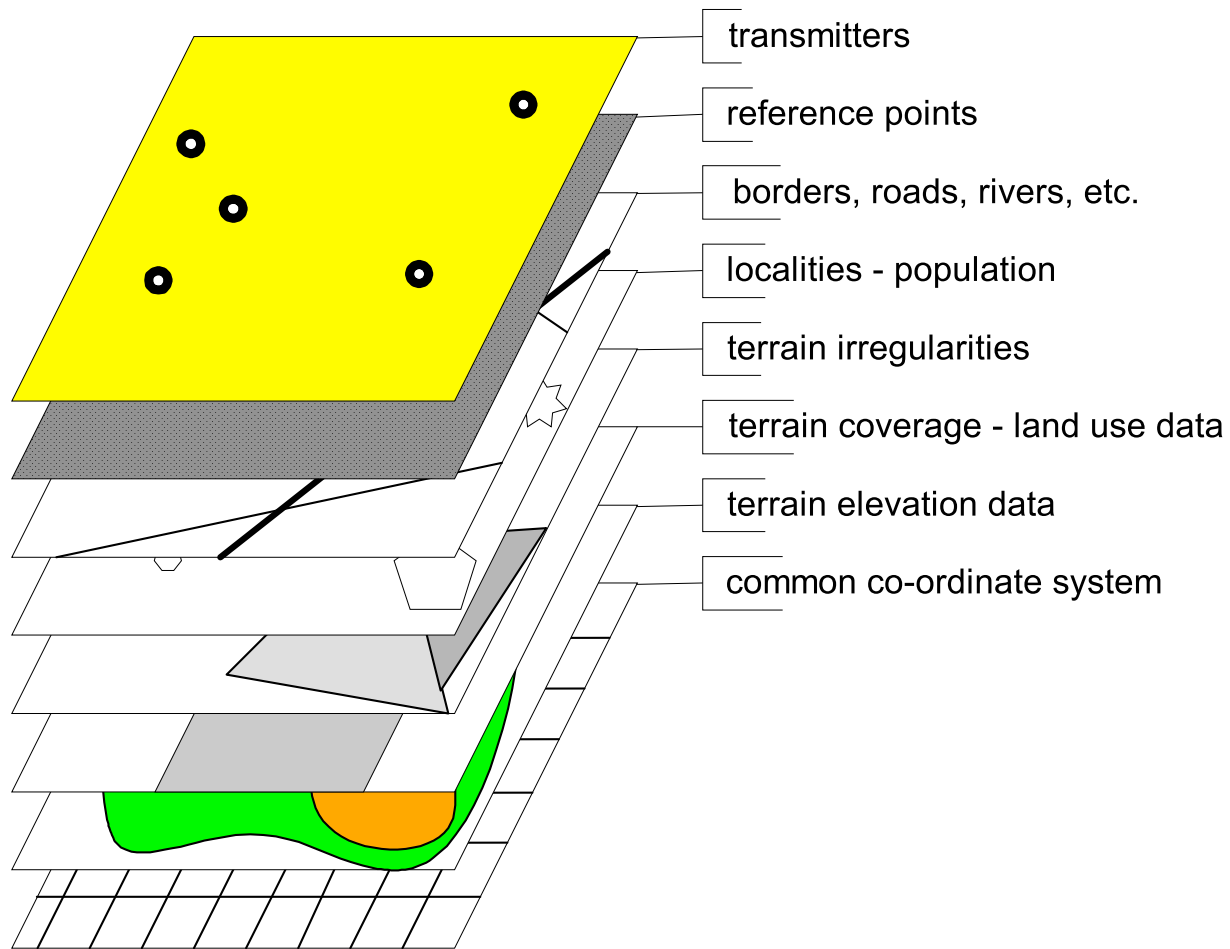

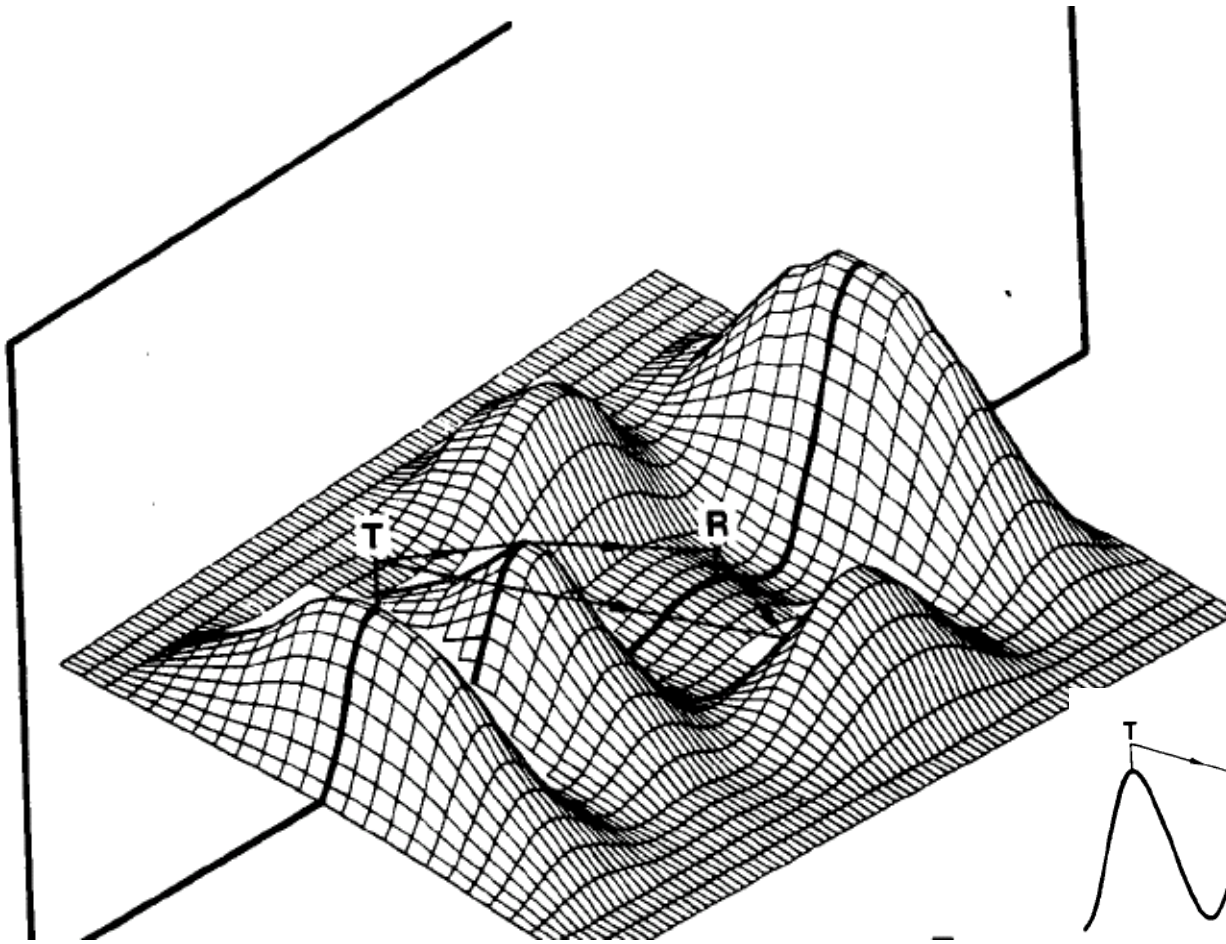

- Production of 2-D profile from 3-D DTM

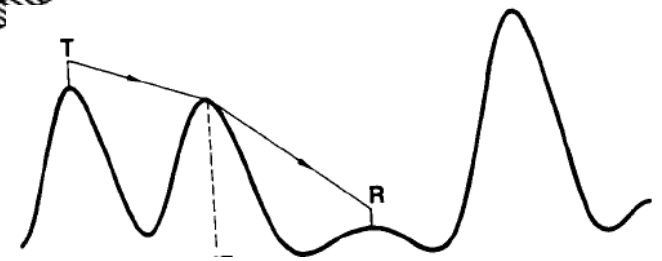

- Direct geodetic terrain measurements
- Scanning/ digitizing paper maps/ plans
- Scanning/ digitizing aerial photographs
- Scanning/ digitizing satellite photographs
- Direct stereoscopic satellite/ aerial radar/ lidar/ infrared measurements

DTM production

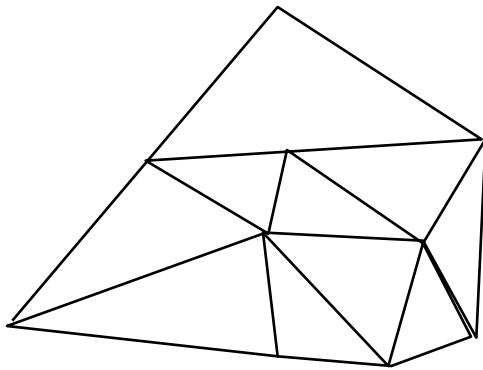

- Irregularly-distributed data (triangulation)
- Regularly-distributed data (x_i, y_i)

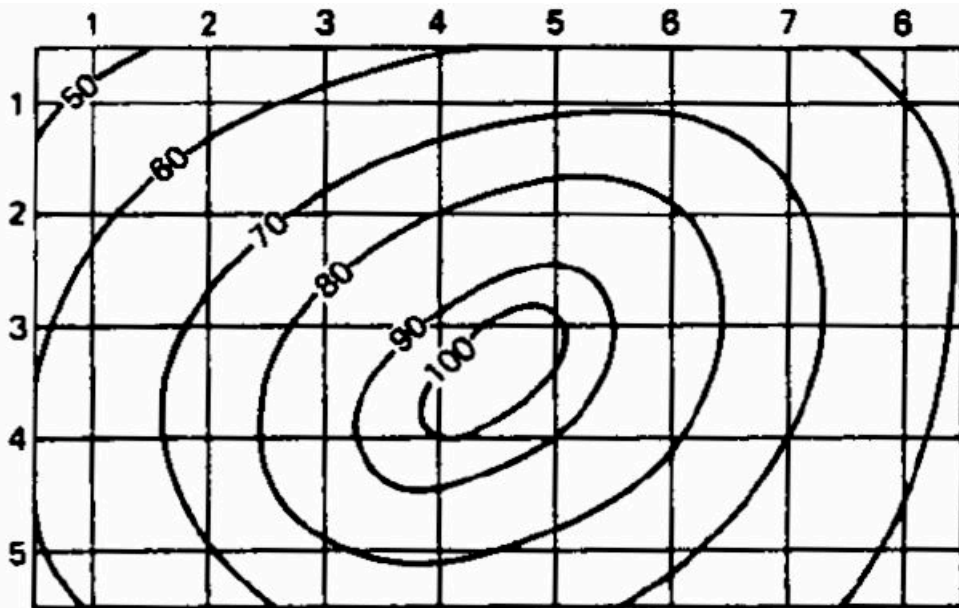

		Column							
		1	2	3	4	5	6	7	8
Row	1	51	58	61	66	69	69	66	60
	2	59	68	73	80	83	81	71	63
	3	63	72	83	94	101	85	73	63
	4	64	74	86	100	90	81	70	62
	5	63	70	79	81	78	72	65	59

- DTM (height) produced from a 'paper map' as set of interpolated numerical values at intersections of grid lines

Digital terrain elevation maps

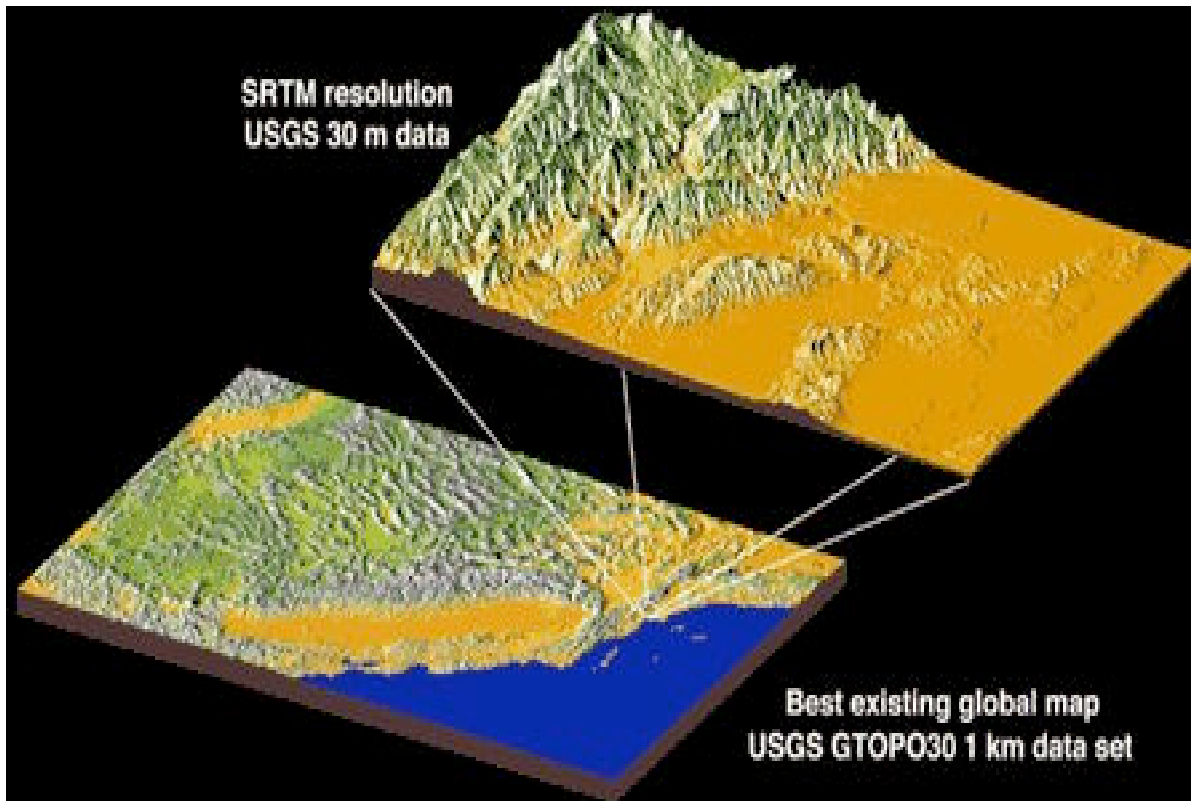

Most of DTM & DTED were created from paper maps

Recently, they were also produced from radar data collected from satellite

Best resolution: 1 arc-sec (~30 m)

30 times as precise as the best global maps in use today. First such maps were planned for 2004.

Source: NASA (<http://www2.jpl.nasa.gov/srtm/>)

Radar Topography

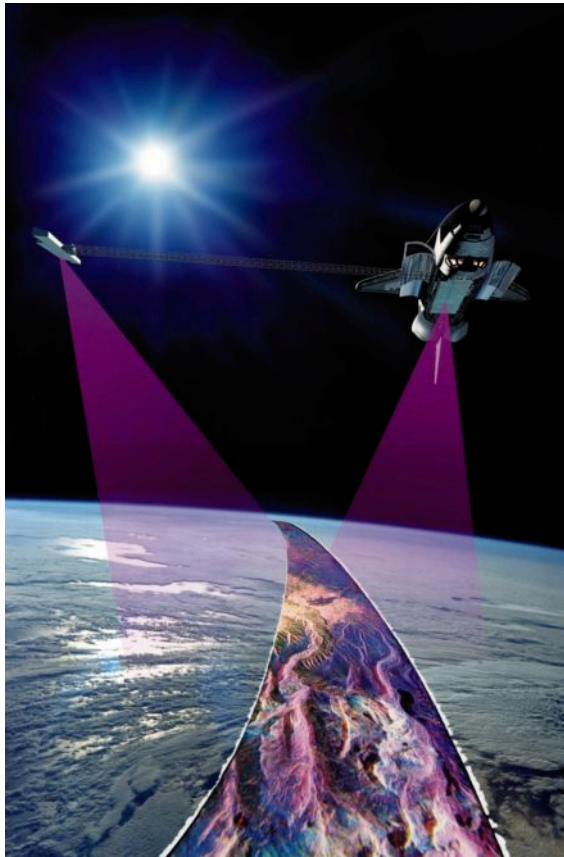

Radar interferometry compares two radar images taken at slightly different locations

Combining the two images produces a single 3-D image.

Shuttle Radar Topographic Mission (SRTM) used single-pass interferometry: the two images were acquired at the same time -- one from the radar antennas in the shuttle's payload bay, the other from the radar antennas at the end of a 60-meter mast extending from the shuttle.

Source: NASA

Shuttle Radar Topography Mission 2000

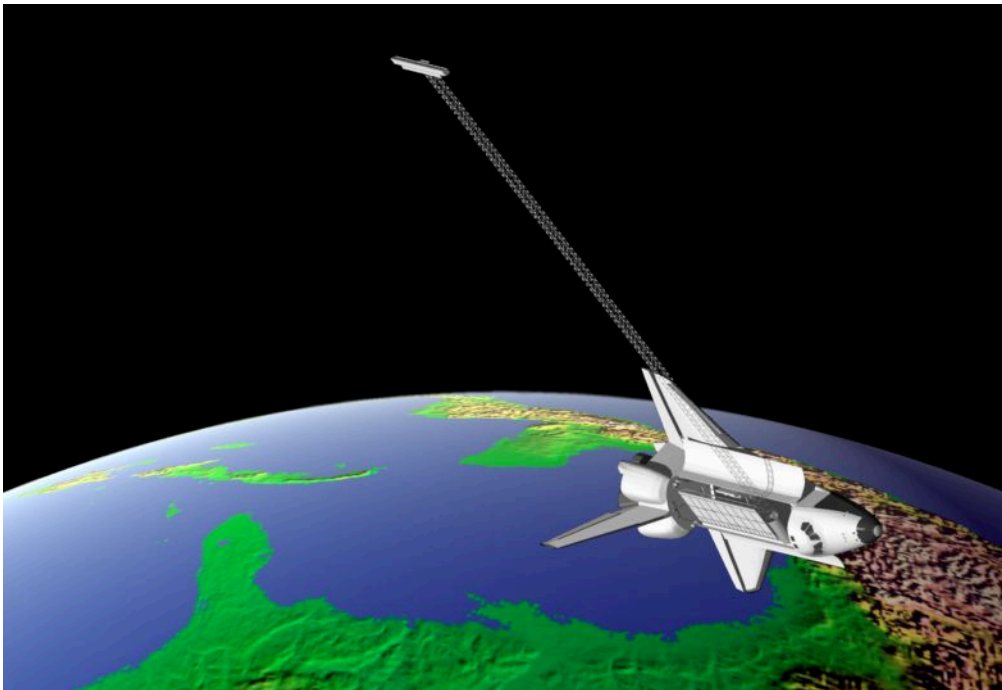

- Mission: 11-22 Feb. 2000
- Collected: 9 terabytes of raw data (~15,000 CDs)
- More than 80 hours data recording

- Orbiter: Shuttle Endeavour (7.5km/sec)
- Nominal altitude: 233 km (with orbital adjustment once per day)
- Inclination: 57 degrees
- 6-member crew
 - to activate payload, deploy and stow mast, align inboard and outboard structures, monitor payload flight systems, operate on-board computers & recorders, & handle contingencies

Source: NASA

Google Earth

- Download: <http://earth.google.com/download-earth.html>

Summary

What we have learned

- Radio propagation conditions decide on the system performance
- The best transmitter, receiver, antennas, cables, etc. may not work as expected if the relevant propagation effects are ignored or incorrectly taken into consideration
- The propagation mechanisms of the wanted signal and unwanted signals must be carefully analyzed

Selected references

- Some software available at ICTP:
 - MLINK
 - RadioMobile
 - ITS Irregular Terrain Model
 - SEAMCAT
- International recommendations
 - ITU-R recommendations series SG3
 - http://www.itu.int/publications/main_publ/itur.html
 - Major propagation models & related computer programs: see ITU (www.itu.int) and ERO documents (e.g. www.ero.dk/seamcat - free!)
- Books:
 - Shigekazu Shibuya: *A basic atlas of radio-wave propagation*; Wiley
 - Freeman RL: *Radio System Design for Telecommunications*, Wiley
 - Coreira LM: *Wireless Flexible Personalised Communications*, Wiley
 - » Acknowledgment: Some of the material is based on Dr. Kevin Hughes' presentations at previous ICTP Schools

Any question?

Thank you for your attention