

# Digital Video Measurements

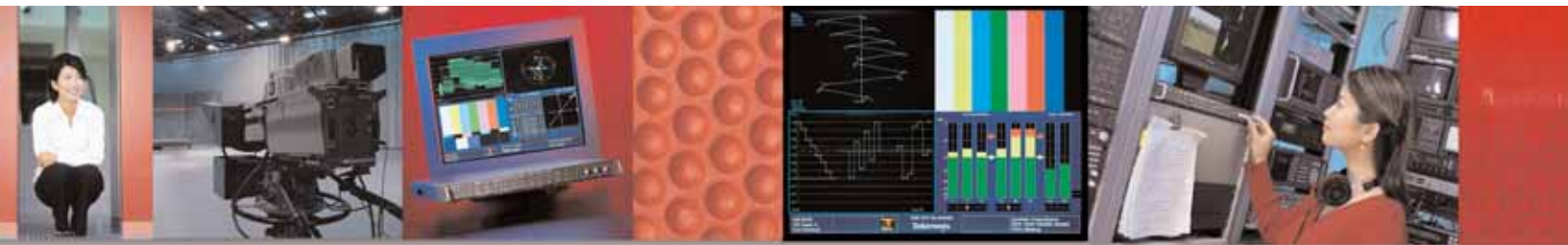

A Guide to Standard and High-Definition Digital Video Measurements



▶ A Guide to Standard and High-Definition Digital Video Measurements	
▶ Contents	
▶ In The Beginning	1
Traditional television	1
▶ The “New” Digital Television	2
Numbers describing an analog world	2
Component digital video	2
▶ Moving Forward from Analog to Digital	3
The RGB component signal	3
Gamma correction	4
Gamma correction is more than correction for CRT response	5
Conversion of R'G'B' into luma and color difference	5
▶ The Digital Video Interface	7
601 sampling	9
The parallel digital interface	11
The serial digital interface (SDI)	12
High-definition video builds on standard definition principles	14
▶ Timing and Synchronization	17
Analog video timing	17
Horizontal timing	18
Vertical timing	20
Analog high-definition component video parameters	24
▶ Digital Studio Scanning Formats	25
Segmented frame production formats	25
▶ Digital Studio Synchronization and Timing	27
Telecine synchronization	30
▶ Digital Audio	31
Embedded audio in component digital video	32
Extended embedded audio	33
Systemizing AES/EBU audio	34
Basic HD embedded audio	35
Audio control packet	37
▶ Video Measurements	38
Monitoring and measuring tools	38
Monitoring digital and analog signals	39
Assessment of video signal degradation	39
Video amplitude	39
Signal amplitude	40
Frequency response	42

Group delay	42
Non-linear effects	43
Differential gain	44
Differential phase	44
Timing between video sources	44
Intrachannel timing of component signals	44
Waveform method	44
Timing using the Tektronix Lightning display	45
Bowtie method	46
<b>▶ Operating a Digital Television System</b>	<b>48</b>
RGB and color-difference waveforms	48
Component gain balance	48
The vector display	48
The Lightning display	50
The Diamond display	51
The Arrowhead display	52
<b>▶ Digital System Testing</b>	<b>53</b>
Stress testing	53
Cable length stress testing	53
SDI check field	53
CRC error testing	54
Jitter testing	54
Eye pattern testing	55
Conclusion	56
<b>▶ Appendix A – Color and Colorimetry</b>	<b>57</b>
White	58
Red, green, and blue components	58
Gamut, legal, valid	61
Format conversion tables	63
<b>▶ Appendix B – Television Clock Relationships</b>	<b>65</b>
<b>▶ Appendix C – Standard Definition Analog Composite Video Parameters</b>	<b>67</b>
<b>▶ Appendix D – Reference Standards and Practices for Television</b>	<b>69</b>
<b>▶ Appendix E – Bibliography</b>	<b>71</b>
<b>▶ Appendix F – Glossary</b>	<b>73</b>
Acknowledgements	81
About the authors	81
Disclaimer	81

## ▶ In The Beginning

It is tempting to think of digital television as something very scientific and even complex. But when we view the end result, we find something very familiar; something television engineers have sought since the very beginning... an experience that just keeps getting better and better... quality video and audio conveying the artist's performance to the viewing audience. The only thing new in digital television is the way the message gets from here to there.

Does it really matter how the message travels? The artist and the viewer (and in many countries, the advertiser) probably don't care what path the signal takes. They can benefit from digital television's improved performance without knowing the details. Ah, but the science... that's where the fun comes in. Those of us involved in the technical side of television do care; and we do benefit from the significant advances in television science over the past 60+ years... and in particular the advances brought about by digital television over the past 20 years.

Program video, digital audio, and associated ancillary data signals together make up the digital television signal. In the analog world of television, video and audio can exist in totally separate paths from source to the home television receiver. Digital signals may be organized with much more freedom, with video, audio, and other signals working together as a stream of data. All we need to know is how the data is organized to pick out what we want.

### Traditional television

We can call analog video and analog audio the elements of traditional television. But it is important to realize we are still trying to accomplish the traditional goals... and maybe more. Digital television builds on analog, and our understanding of digital television builds on what we already know

about analog television. Light into the camera lens and sound into the microphone, are still analog. Light from the display and sound to your ears are still analog phenomena.

We already know that analog video is a "sampling" of light values. Values of brightness represented by a voltage. And additional information provides the color of the samples. The samples are synchronized through the transmission system to reproduce an image of the original scene on our display. Analog video travels as a "serial" stream of voltage values containing all of the "data" necessary to make a picture when the receiver knows what to do with the information. So you can see that by just substituting a few words, and by just doing a few things differently to take advantage of what we have learned over the past fifty years, we can understand that digital video is really not very different than analog video.

So if we start with analog light and end with analog light, why use digital video at all? In many cases, the camera sensor is still producing analog video, but it is now common to almost immediately convert the varying analog voltage representing the instantaneous value of video to digital for handling with essentially no degradation. In some cases, such as computer-generated video or graphics, the video will start out in digital format, and with the new digital television systems, it can reach the display never going to analog.

We can still send and receive television signals via analog NTSC, PAL, or SECAM transmissions, but we are already using digital transmissions to convey higher quality, more efficient television signals to the home. Digital television is an available part of everyday life. Some of us will use it and contribute to its improvement. Some of us will take advantage of it without needing to know the details.

### ▶ The “New” Digital Television

Digital signals have been a part of television for many years, at first buried inside equipment such as test signal and character generators; later throughout entire systems. In this primer, we will deal first with the video portion of the television signal for simplicity. Audio will be digital as well, and will take its place in the digital data stream for recovery at the television receiver. Digital audio will be discussed in later chapters.

Digital video is a simple extension of analog video. Once we understand analog video, it is easy to understand how digital video is created, handled, processed, and converted to and from analog. Analog and digital video have many of the same constraints, and many of the problems that may occur in the digital domain are a result of incorrect analog source video. Therefore, it is important to have standards to reference for the design and operation of both analog and digital video devices.

#### Numbers describing an analog world

Early digital video was merely a digital description of the analog NTSC or PAL composite analog video signal. Standards were written to describe operating limits and specify the number data describing each voltage level and how each number was generated and recovered. Because of the high speed of the data, it was common to handle digital video data internally on an eight- or ten-bit bus, and initial standards described a multi-wire external connection as well. The standards also described certain ancillary and housekeeping data to synchronize the receiver and the transported data, and to permit additional services such as embedded audio. Later, as higher processing speeds became practical, a single wire composite serial interface standard was developed. In its basic form, digital video is a numeric representation of analog voltage, with number data occurring fast enough to accommodate changing video and necessary ancillary data.

#### Component digital video

The designers of early analog special effects equipment recognized the advantage of keeping the red, green, and blue video channels separate as

much as possible during any processing. The NTSC and PAL encoding/decoding process is not transparent and multiple generations of encoding and decoding progressively degrade the signal. The signal in the camera starts out with independent channels of red, green, and blue information, and it is best to handle these signals through the system with as few format generations as possible before encoding them into NTSC or PAL for transmission to the home. But handling three separate coordinated channels of information through the television plant presents logistic and reliability problems. From a practical standpoint, these three signals should all coexist on one wire, or commonly a single coaxial cable. As it turns out, we can simply matrix these three components, the red, green, and blue video channels, to a more efficient set consisting of luma and two color-difference signals; digitize each of them, and multiplex the data onto a single coaxial cable. We can handle this data signal much as we do traditional NTSC or PAL composite video. Now we are handling a high speed stream of numeric data. Although this data signal contains energy changing at a much faster rate than the 5 to 6 MHz energy in an NTSC or PAL video signal, it can be handled losslessly and with less maintenance over reasonable distances. Once the video signal is in the digital domain, we can easily extract its components for individual processing and recombine them again in the digital domain without any further loss or interaction among the channels.

Component and digital techniques contribute significant advantages in video quality control, and the speed of digital devices has made the bandwidth of high-definition video practical. Digital also lends itself to processing with various compression algorithms to reduce the total amount of data needed. It is now possible to convey high-definition video and associated multichannel audio in the bandwidth required for high quality real-time analog video. The subject of video compression is covered in many publications (see **Bibliography**) and will not be addressed in this primer.

## ▶ Moving Forward from Analog to Digital

The digital data stream can be easily broken down into its separate components, often serving the same function as their analog counterparts. We will continue with this analogy as we describe and compare the analog and digital video domains. Once we clearly understand the similarity between analog and digital video we can move to HDTV, which is often a digital representation of the corresponding high-definition analog format.

NTSC and PAL video signals are composites of the three camera channels, the primary color components red, green, and blue, matrixed together to form a luminance channel summed with the modulation products of a suppressed subcarrier containing two channels of color information. A third system of single-channel composite transmission is the SECAM system, which uses a pair of frequency-modulated subcarriers to convey chroma information. In the studio, there is no specific requirement that the signal be NTSC, PAL, or SECAM at any point between the camera RGB pickup devices and the RGB channels of the final display device. While an understanding of NTSC, PAL, or SECAM is useful, we need not invest in any new study of composite video.

### The RGB component signal

A video camera splits the light of the image into three primary colors – red, green, and blue. Sensors in the camera convert these individual monochrome images into separate electrical signals. Synchronization information

is added to the signals to identify the left edge of the picture and the top of the picture. Information to synchronize the display with the camera may be added to the green channel or occasionally added to all three channels, or routed separately.

The simplest hookup, as shown in Figure 1, is direct R, G, and B, out of the camera, into the picture monitor. The multi-wire transmission system is the same for analog standard or analog high-definition video. A multi-wire connection might be used in small, permanently configured sub-systems.

This method produces a high quality image from camera to display, but carrying the signals as three separate channels, involves the engineer in ensuring each channel processes the signals with the same overall gain, DC offset, time delay, and frequency response. A gain inequality or DC offset error between the channels will produce subtle changes in the color of the final display. The system could also suffer from timing errors, which could be produced from different lengths of cable or different methods of routing each signal from camera to display. This would produce timing offset between the channels producing a softening or blurring in the picture – and in severe cases multiple, separated images. A difference in frequency response between channels would cause transient effects as the channels were recombined. Clearly, there is a need to handle the three channels as one.

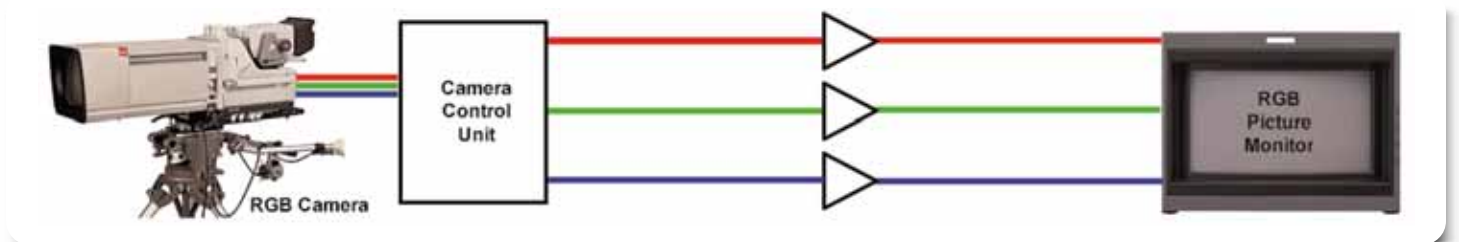

▶ **Figure 1.** RGB from the camera with direct connections to the monitor.

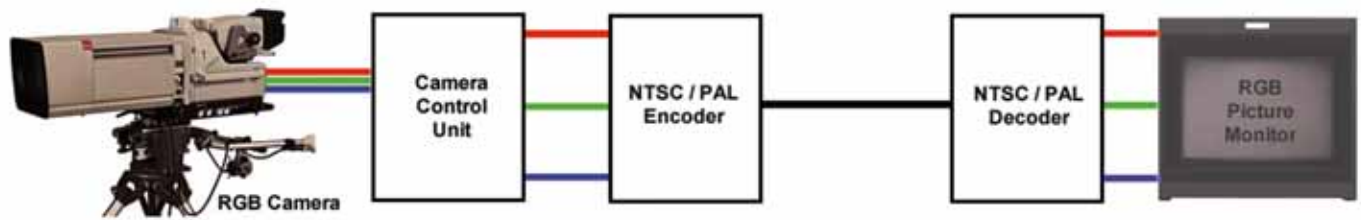

▶ **Figure 2.** Video encoded to NTSC or PAL for transmission on a single coaxial cable.

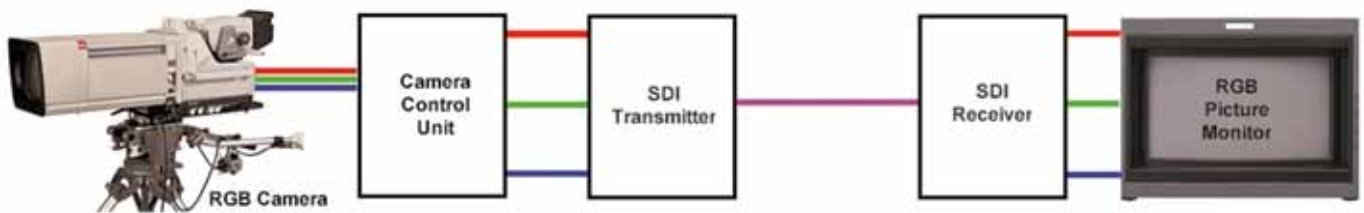

▶ **Figure 3.** Digital transmission avoids analog signal degradation.

Insertion of an NTSC or PAL encoder and decoder (Figure 2) does nothing for simplicity except make the signal easier to handle on one wire within the television plant. System bandwidth is compromised in a friendly way to contain the energy of the three-video signals in 4.2 MHz (NTSC) or 5.0 to 5.5 MHz (PAL). The single-wire configuration makes video routing easier, but frequency response and timing must be considered over longer paths. Because both chroma and luma in the NTSC or PAL composite signal share the 4.2 MHz, 5.0 or 5.5 MHz, multiple generations of encoding and decoding must be avoided.

By substituting component digital encoders and decoders, the hookup (Figure 3) is no more complex and is better in performance. Energy in the single coaxial cable is now at a data rate of 270 Mb/s for standard definition signals; 1.485 Gb/s or higher for high-definition signals. Standard definition signals could be converted to analog NTSC or PAL for transmission within traditional broadcast television channels. High-definition signals must be compressed for on-air transmission within the channel bandwidth of existing NTSC or PAL channels.

## Gamma correction

An analog factor to be considered in the handling of the video signal is the perception that the video display is accurately reproducing the brightness of each element of the scene. The Cathode Ray Tube (CRT) display is an inherently non-linear device and therefore, the amount of light output is a non-linear function of the voltage applied to the display. This function is called the gamma of the device. In order to produce a linear response, a correction factor must be applied within the TV System. Therefore, the RGB signals in the camera are gamma-corrected with the inverse function of the CRT. Gamma corrected signals are denoted  $R'$ ,  $G'$ , and  $B'$ ; the prime mark (') indicating a correction factor has been applied to compensate for the transfer characteristics of the pickup and display devices. Although the prime mark may appear a bit cumbersome, and is sometimes incorrectly omitted, it will be used throughout this primer for correlation with standards documents.

New LCD and Plasma display technologies are becoming more prevalent today, so one would think that gamma correction would not be needed in the future. However the human visual response to luminance is also a power function; approximately intensity raised to the  $1/3$  power. For best



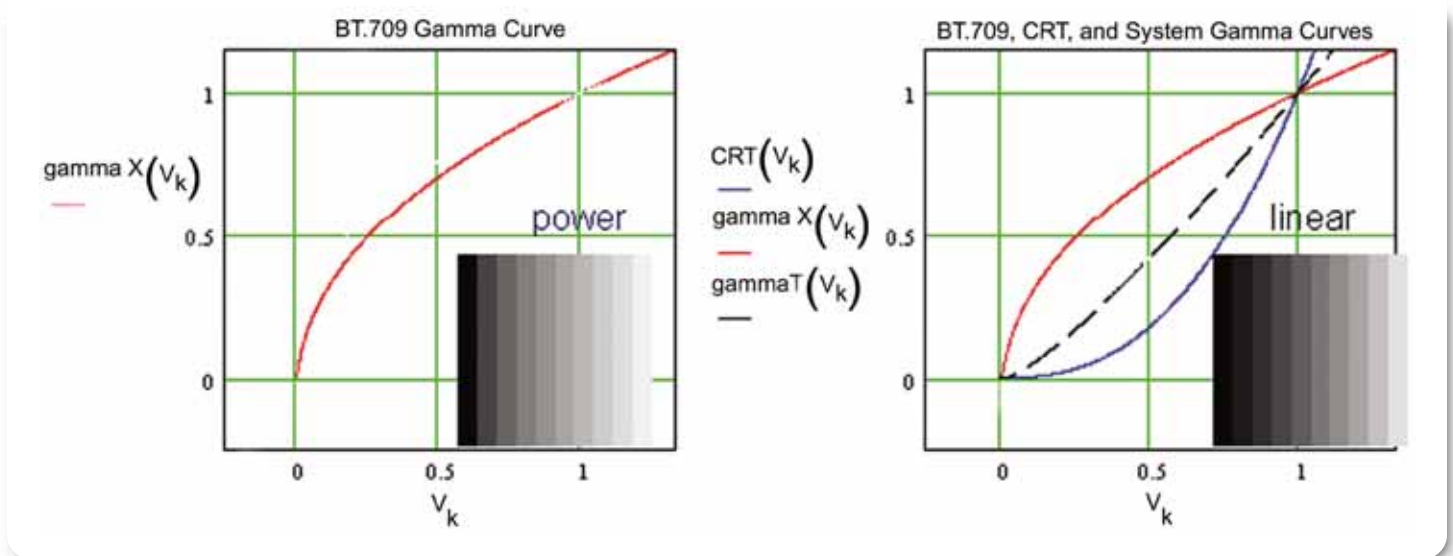

▶ **Figure 4.** BT.709 gamma correction compliments CRT display response.

contrast representation and signal to noise (S/N), video encoding uses this same power function. This is called conceptual coding.

### Gamma correction is more than correction for CRT response

The gamma correction needed for the CRT is almost optimal for conceptual correction. For this reason, care should be taken when evaluating systems where correction factors have been applied within the devices for gamma correction.

Figure 4 shows the gamma correction as a power function of 0.45 as specified in ITU-R BT.709, a predominant standard for digital high-definition video. This gamma correction is applied at the camera to correct for nonlinearities at the CRT and provide conceptual coding. Nonlinearities in the CRT exist as a power function between 2.2 to 2.6, and most CRTs have a value of about 2.5. The resulting total system gamma is about 1.2, which is nearly ideal for typical viewing conditions. This response roughly corrects for human lightness perception, which in turn reduces the number of bits required when the video signal is digitized for transmission.

### Conversion of R'G'B' into luma and color-difference

Video components red, green, and blue are native to the camera pickup devices and are almost always used by operators in managing video color. RGB, however, is not the most bandwidth-efficient method of conveying the image during video processing because all three components must be equal bandwidth. Human vision is more sensitive to changes in luminance detail than to changes in color, so we can improve bandwidth efficiency by deriving full bandwidth luma information and allot any remaining available bandwidth to color-difference information.

Processing of the video signal components into luma and color-difference values reduces the amount of information that must be conveyed. By having one full bandwidth luma channel ( $Y'$ ) represent the brightness and detail of the signal, the two color-difference channels ( $R'-Y'$  and  $B'-Y'$ ) can be limited to about half the luma channel bandwidth and still provide sufficient color information. This allows for a simple linear matrix to convert between R'G'B' and  $Y', R'-Y', B'-Y'$ . Bandwidth limiting of the color-difference channels is done after the matrix. When the channels are restored to

Table 1. Luma and Chroma Video Components

Y', R'-Y', B'-Y' commonly used for analog encoding

Format	1125/60/2:1, 720/60/1:1	525/59.94/2:1, 625/50/2:1, 1250/50/2:1
Y'	$0.2126 R' + 0.7152 G' + 0.0722 B'$	$0.299 R' + 0.587 G' + 0.114 B'$
R'-Y'	$0.7874 R' - 0.7152 G' - 0.0722 B'$	$0.701 R' - 0.587 G' - 0.114 B'$
B'-Y'	$-0.2126 R' - 0.7152 G' + 0.9278 B'$	$-0.299R' - 0.587 G' + 0.886 B'$

Y', P'b, P'r analog component

Format	1125/60/2:1 (SMPTE 240M)	1920 x 1080 (SMPTE 274M) 1280 x 720 (SMPTE 296M)	525/59.94/2:1, 625/50/2:1, 1250/50/2:1
Y'	$0.212R' + 0.701G' + 0.087B'$	$0.2126R' + 0.7152G' + 0.0722B'$	$0.299R' + 0.587G' + 0.114B'$
P'b	$(B'-Y') / 1.826$	$[0.5 / (1 - 0.0722)] (B'-Y')$	$0.564 (B'-Y')$
P'r	$(R'-Y') / 1.576$	$[0.5 / (1 - 0.2126)] (R'-Y')$	$0.713 (R'-Y')$

Y', C'b, C'r, scaled and offset for digital quantization

Format	1920x1080 (SMPTE 274M) 1280x720 (SMPTE 296M)	525/59.94/2:1, 625/50/2:1, 1250/50/2:1
Y'	$0.2126 R' + 0.7152 G' + 0.0722 B'$	$0.299 R' + 0.587 G' + 0.114 B'$
C'b	$0.5389 (B'-Y') + 350 \text{ mV}$	$0.564 (B'-Y') + 350 \text{ mV}$
C'r	$0.6350 (R'-Y') + 350 \text{ mV}$	$0.713 (R'-Y') + 350 \text{ mV}$

R'G'B' for display, brightness detail is restored at full bandwidth and spatial color detail is limited in an acceptable manner. The following paragraphs and tables discuss the conversion process for R'G'B' to Y', R'-Y', B'-Y' that takes place within encoders and decoders.

Gamma-corrected R'G'B' components are matrixed to create gamma-corrected component luma, designated Y', and two color-difference components. The luma and color-difference components are derived from R', G'

and B' to the values shown in Table 1 (the unit of each coefficient is in volts).

Table 1 shows the range of voltages for the conversion of R'G'B' to Y', (R'-Y'), (B'-Y'). The luma signal has a dynamic range of 0 to 700 mv. The color-difference signals, R'-Y' and B'-Y', may have different dynamic ranges dependent on the scaling factors for conversion to various component formats. The analog component format denoted by Y'P'bP'r is scaled so that both color-difference values have a dynamic range of  $\pm 350$  mv. This allows for simpler processing of the video signals. Analog Y'P'bP'r values are offset to produce Y'C'bC'r values typically used within the digital standards. The resulting video components are a Y' or luma channel similar to a monochrome video signal, and two color-difference channels, C'b and C'r that convey chroma information with no brightness information, all suitably scaled for quantization into digital data.

A number of other color-difference formats are in use for various applications. In particular it is important to know that the coefficients currently in use for composite PAL, SECAM, and NTSC encoding are different, as shown in Table 2.

Table 2. Luma and Chroma Values for Composite Video Encoding

Component	Approximate value (SMPTE 170M and ITU-R BT.470-6)
Y	$0.299 R' + 0.587 G' + 0.114 B'$
NTSC I	$-0.2680 (B' - Y') + 0.7358 (R' - Y')$
NTSC Q	$+0.4127 (B' - Y') + 0.4778 (R' - Y')$
PAL U	$0.493 (B' - Y')$
PAL V	$0.877 (R' - Y')$
SECAM Dr	$-1.902 (R' - Y')$
SECAM Db	$1.505 (B' - Y')$

▶ The Digital Video Interface

A quick overview of the digital interface connecting our analog world of video is appropriate at this point. The block diagrams in Figures 5 through 8 can help you understand how video production equipment handles digital component video signals. Although these block diagrams illustrate a standard definition system, the concept holds for high-definition formats. In high-definition formats, sampling and data rates will be faster and separate 10-bit busses for luma and chroma may be maintained further through the system to minimize the amount of circuitry operating at high data rates.

Gamma-corrected RGB (Figure 5) is converted in a linear matrix to a luma component,  $Y'$ , and two scaled chroma components,  $P'b$  and  $P'r$ . Since the

eye is more sensitive to changes in brightness (detail) than to changes in hue, the  $Y'$  signal will be carried through the system at a higher bandwidth (5.5 MHz in standard definition). The luma and chroma signals are low-pass filtered to eliminate higher video frequencies that might cause aliasing in the sampling (digitizing) process. The filtered luma signal is sampled at a rate of 13.5 MHz in an analog-to-digital converter to produce a ten-bit data stream at 13.5 MB/s. The two chroma channels are filtered, then sampled at 6.75 MHz in analog-to-digital converters to produce two data streams at 6.75 MB/s. The three video channels are multiplexed to a single 10-bit parallel data stream at 27 MB/s.

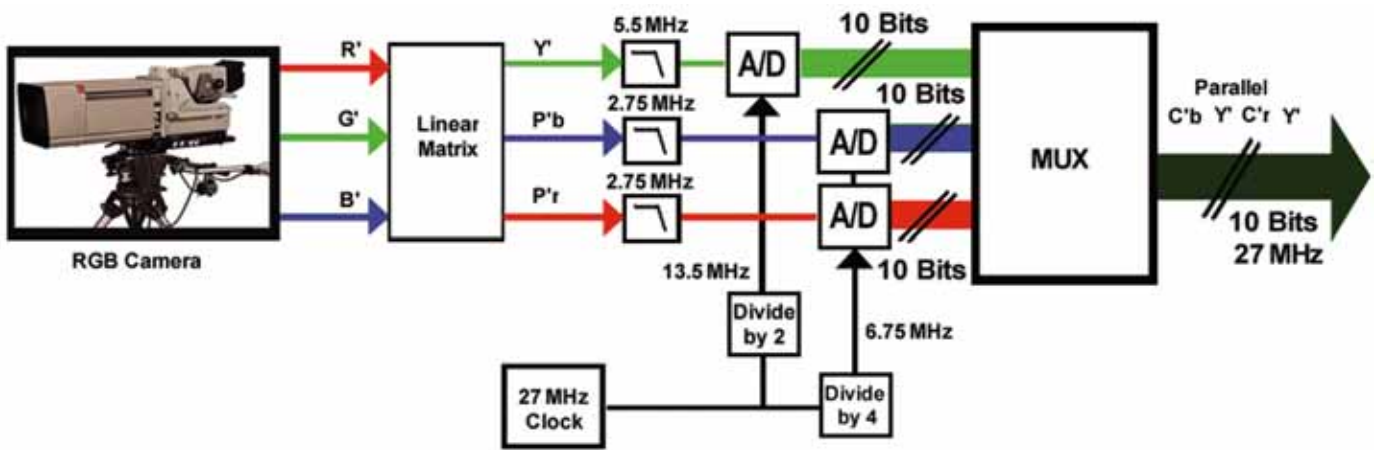

▶ Figure 5. Digitizing RGB camera video.

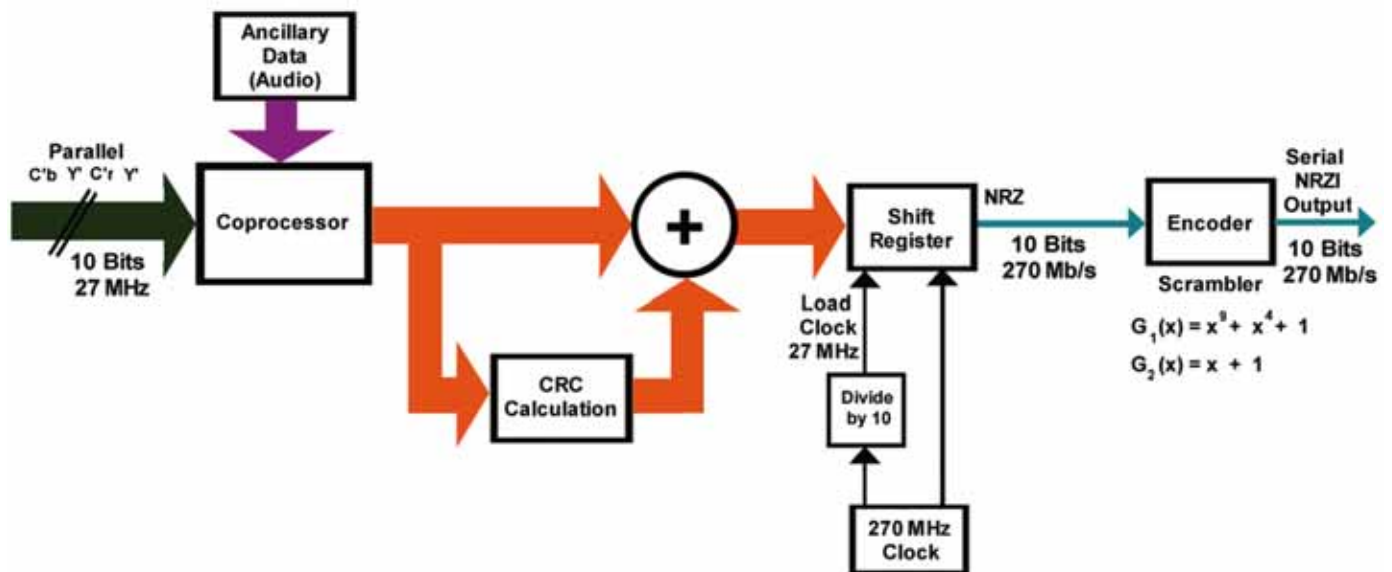

► **Figure 6.** Processing and serializing the parallel data stream.

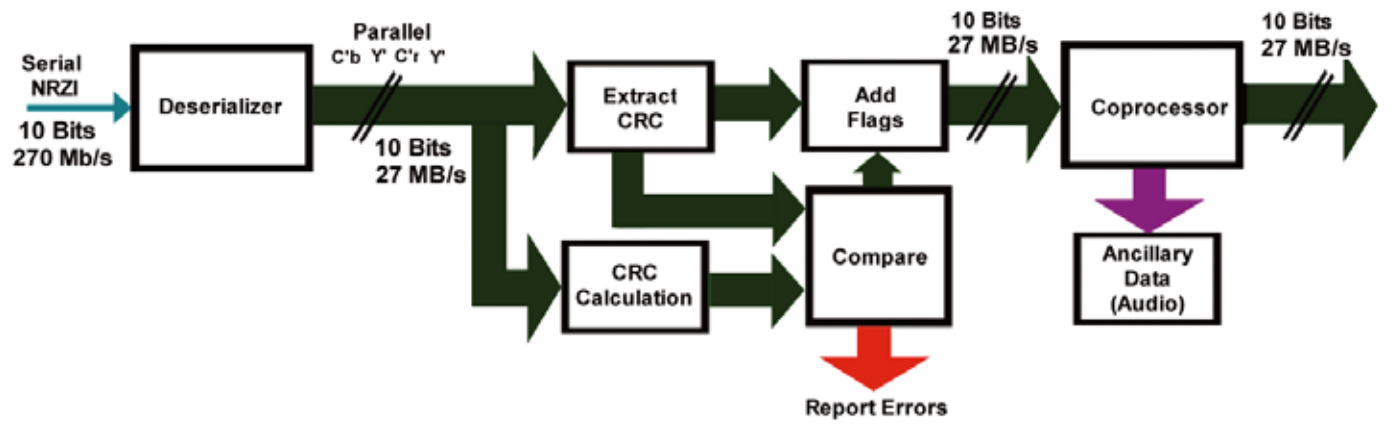

► **Figure 7.** SDI Receiver – deserializes the video data to parallel.

A co-processor (Figure 6) is used to add timing reference signals, AES/EBU formatted digital audio, and other ancillary data. A checksum is calculated for the data and added to the parallel data stream.

The 27 MB/s, 10-bit parallel data is then loaded into a shift register, or serializer, where it is clocked out at a 270 Mb/s rate and scrambled for efficient transmission compliant with, in this example, standard definition ITU-R.BT-656/SMPTE 259M.

Standard definition ITU-R.BT-656/SMPTE 259M compliant signals can be carried by standard video cables up to about 300 meters with near 100% data integrity. high-definition SMPTE 292M compliant signals at a data rate of 1.485 Gb/s are limited to about 100 meters.

At the receiver (Figure 7), energy at half-clock frequency is sensed to apply an appropriate analog equalization to the incoming 270 Mb/s data signal. A new 270 MHz clock is recovered from the NRZI signal edges, and the equalized signal is sampled to determine its logic state. The deserializer

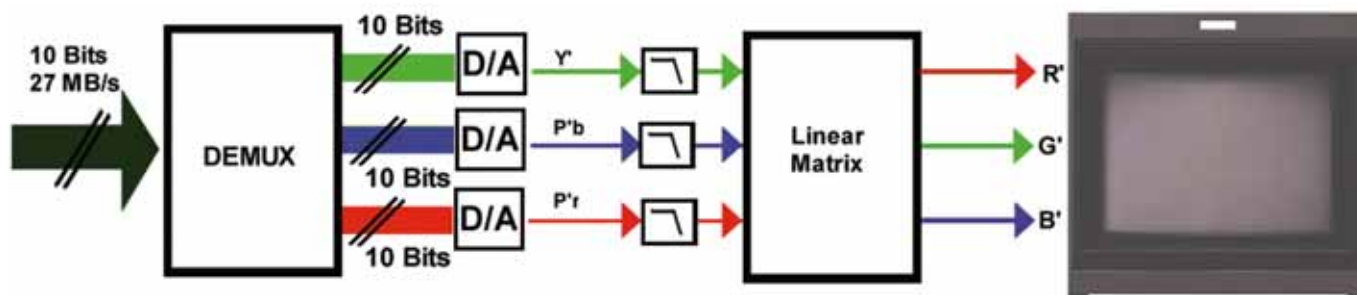

▶ **Figure 8.** Recovering analog R'G'B' from parallel data.

unscrambles the data using an algorithm complimentary to the encoder's scrambling algorithm and outputs a 10-bit data stream at 27 MB/s. The embedded checksum is extracted by the receiver and compared with a new checksum produced from the received data and any error is reported and an appropriate flag added to the data stream. A co-processor extracts any audio or other ancillary data.

The 10-bit data is then demultiplexed (Figure 8) into digital luma and chroma data streams, converted to analog by three digital-to-analog converters, filtered to reconstruct the discrete data levels back to smooth analog waveforms, and matrixed back to the original R'G'B' for display.

This quick system overview will help us understand how the system operates. Additional details of the digital interface are provided in the paragraphs to follow.

### 601 sampling

ITU-R BT.601 is the sampling standard that evolved out of a joint SMPTE/EBU task force to determine the parameters for digital component video for the 625/50 and 525/60 television systems. This work culminated in a series of tests sponsored by SMPTE in 1981, and resulted in the well-known CCIR Recommendation 601 (now known as ITU-R BT.601). This document specifies the sampling mechanism to be used for both 525 and 625 line signals. It specifies orthogonal sampling at 13.5 MHz for analog luminance and 6.75 MHz for the two analog color-difference signals. The sample values are digital luma  $Y'$  and digital color-difference  $C'b$  and  $C'r$ , which are scaled versions of the analog gamma corrected  $B'-Y'$  and  $R'-Y'$ . 13.5 MHz was selected as the sampling frequency because the sub-multiple 2.25 MHz is a factor common to both the 525 and 625 line systems (see Appendix B – Television Clock Interrelationships).

# A Guide to Standard and High-Definition Digital Video Measurements

## ▶ Primer

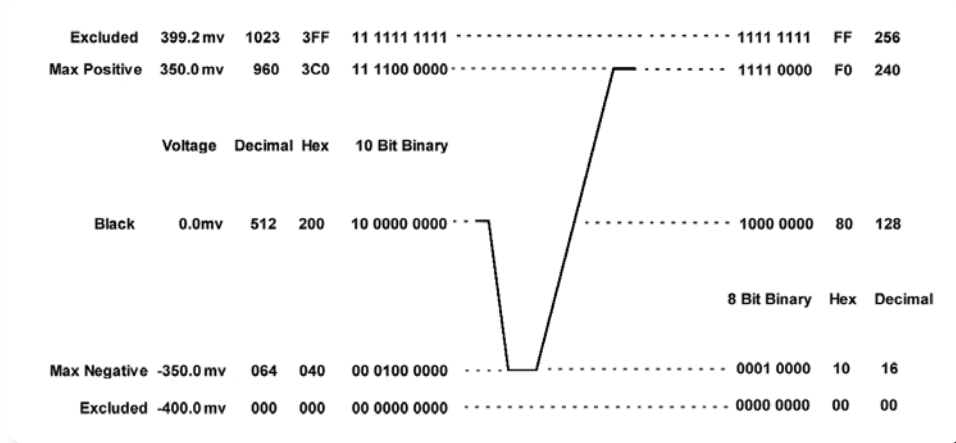

▶ **Figure 9.** color-difference quantizing.

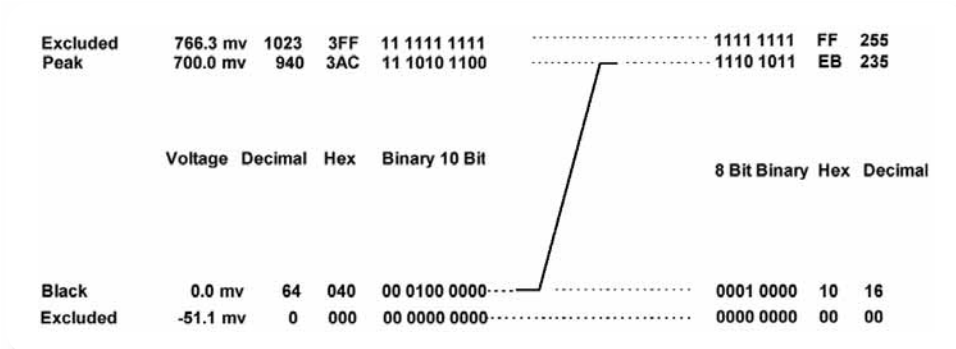

▶ **Figure 10.** Luminance quantizing.

Although many current implementations of ITU-R BT.601 use 10-bit sampling, ITU-R BT.601 permits either 8-bit samples (corresponding to a range of 256 levels,  $00_h$  through  $FF_h$ ), or 10-bit samples (corresponding to a range of 1024 levels,  $000_h$  through  $3FF_h$ ). Specified 8-bit word values may be directly converted to 10-bit values, and 10-bit values may be rounded to 8-bit values for interoperability. color-difference  $C'b$  and  $C'r$  components values in the range  $040_h$  to  $3C0_h$  (Figure 9) correspond to analog signals between  $\pm 350$  mV. Signal excursions are allowed outside this range and the total available range is nominally  $\pm 400$  mV. Luma component values,  $Y'$  (Figure 10) in the range  $040_h$  to  $3AC_h$  correspond to analog signals between 0.0 mV and 700 mV. Signal excursions are again allowed outside this range with a total range of nominally  $-50$  mV to  $+766$  mV to allow greater headroom for overload above the white level. A/D converters are configured to never generate 10-bit levels  $000_h$  through  $003_h$ , and  $3FC_h$  through  $3FF_h$  to permit interoperability with 8-bit systems. Quantizing levels are selected so 8-bit

levels with two “0s” added will have the same values as 10-bit levels. In both luminance and color-difference A/Ds, values  $000_h$  to  $003_h$  and  $3FC_h$  to  $3FF_h$  are reserved for synchronizing purposes.

Figure 11 shows the location of samples and digital words with respect to an analog horizontal line and Figure 12 shows the spatial relationship to the picture area. Because the timing information is carried by End of Active Video (EAV) and Start of Active Video (SAV) packets, there is no need for conventional synchronizing signals. The horizontal blanking interval and the entire line periods during the vertical blanking interval can be used to carry audio or other ancillary data. The EAV and SAV timing packets are identified in the data stream by a header starting with the words:  $3FF_h$ ,  $000_h$ ,  $000_h$ . The fourth word (xyz) in the EAV and SAV packets contains information about the signal. Ancillary data packets in component digital video are identified by a header starting with the words:  $000_h$ ,  $3FF_h$ ,  $3FF_h$ .

The “xyz” word is a 10-bit word with the two least significant bits set to zero to survive an 8-bit signal path. Contained within the standard definition “xyz” word are functions F, V, and H, which have the following values:

- ▶ Bit 8 – (F-bit) 0 for field one and 1 for field two
- ▶ Bit 7 – (V-bit) 1 in vertical blanking interval; 0 during active video lines
- ▶ Bit 6 – (H-bit) 1 indicates the EAV sequence; 0 indicates the SAV sequence

### The parallel digital interface

Electrical interfaces for the data produced by Rec.601 sampling were standardized separately by SMPTE as SMPTE standard 125M for 525/59.94 and by EBU Tech. 3267 for 625/50 formats. Both of these were adopted by CCIR (now ITU) and included in Recommendation 656, the document describing the parallel hardware interface. The parallel interface uses eleven twisted pairs and 25 pin “D” connectors. The parallel interface multiplexes data words in the sequence C'b, Y', C'r, Y'... resulting in a data rate of 27 MB/s. Timing sequences SAV (Start of Active Video) and EAV (End of Active Video) were added to each line. The digital active video line for both 525 and 625 formats includes 720 luma samples, with remaining data samples during analog blanking available for timing and other data.

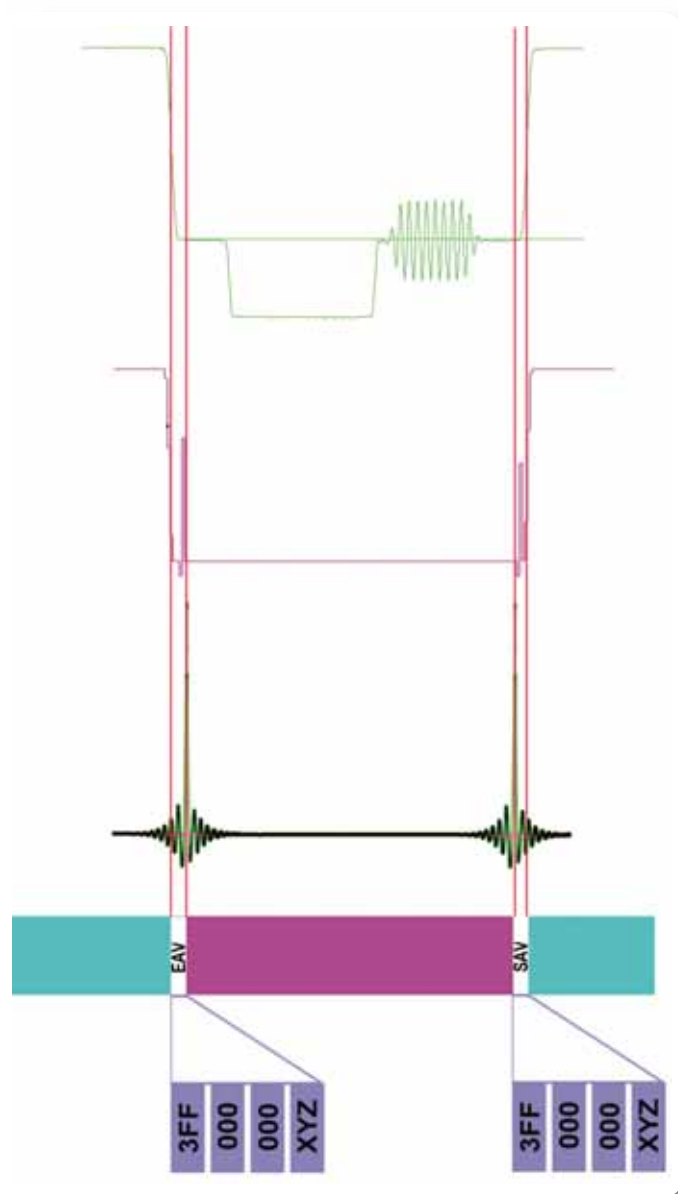

▶ **Figure 11.** Digital horizontal blanking interval.



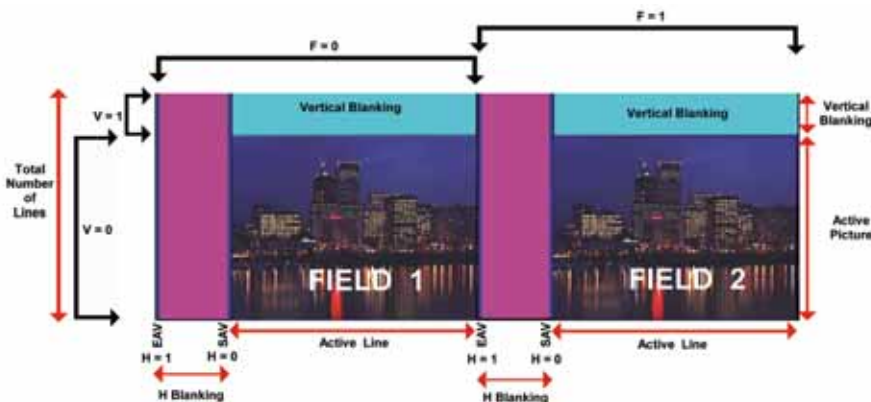

► **Figure 12.** Layout of 2:1 interlaced digital frame.

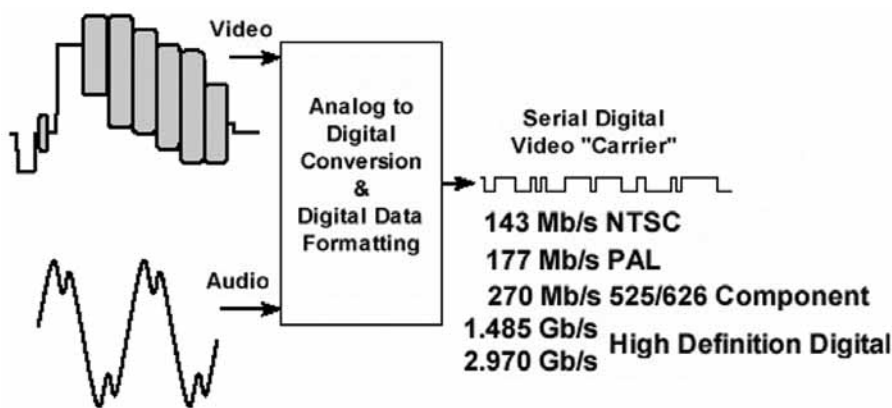

► **Figure 13.** The carrier concept.

Because of the requirement for multiple conductor cables and patching panels, parallel connection of digital studio equipment is practical only for small, permanently configured installations.

**The serial digital interface (SDI)**

Regardless of format, there is a clear need for data transmission over a single coaxial cable. This is not simple because the data rate is relatively high and if the signal were transmitted without modification, reliable recovery would be difficult. The signal must be modified prior to transmission to ensure that there are sufficient edges for reliable clock recovery, to minimize the low frequency content of the transmitted signal, and to spread the energy spectrum so that RF emission problems are minimized. A serial digital interface that uses scrambling and conversion to NRZI was developed to meet these needs. This serial interface is defined in ANSI/SMPTE 259M, ITU-R BT.656, and EBU Tech. 3267, for both standard definition component and composite signals including embedded digital audio. A scaled version of this serial interface is specified for high-definition transmission.

Conceptually, the serial digital interface is much like a carrier system for studio applications. Baseband video and audio signals are digitized and combined on the serial digital "carrier" as shown in Figure 13. Note this is not strictly a carrier system in that it is a baseband digital signal and not a signal modulated on a carrier. The bit rate (carrier

frequency) is determined by the clock rate of the digital data, 270 Mb/s for standard definition component digital and 1.485 Gb/s (or 2.97 Gb/s) for high-definition formats. (Other rates, including 143 Mb/s and 177 Mb/s for NTSC and PAL composite serial interfaces are also used but will not be covered in detail in this primer.)



Parallel data representing the samples of the analog signal components is processed as shown in Figure 14 to create the serial digital data stream. The parallel clock is used to load sample data into a shift register, and a 10x multiple of the parallel clock shifts the bits out, LSB first, for each 10-bit data word. If only 8 bits of data are available, the serializer places zeros in the two LSBs to complete the 10-bit word. In component formats, the EAV and SAV timing signals on the parallel interface provide unique sequences that can be identified in the serial domain to permit word framing. Coding of EAV and SAV data packets is described in the Digital Studio Synchronization and Timing section of this primer. If other ancillary data such as audio has been inserted into the parallel signal, this data will also be carried by the serial interface.

Following serialization of the parallel information, the data stream is scrambled by a mathematical algorithm, then encoded into NRZI (Non-Return to Zero Inverse) by a concatenation of the following two functions:

$$G_1(X) = X^9 + X^4 + 1$$

$$G_2(X) = X + 1$$

Scrambling the signal makes it statistically likely to have a low DC content for easier handling and have a great number of transitions for easier clock recovery. NRZI formatting makes the signal polarity-insensitive.

At the receiver, the inverse of this algorithm is used in the deserializer to recover the correct data so the end user sees the original, unscrambled components. In the serial digital transmission system, the clock is contained in the data as opposed to the parallel system where there is a separate clock line. By scrambling the data, an abundance of transitions is assured as required for clock recovery. For system stress testing (see Digital System Testing section), specific test signals have been developed that introduce sequences

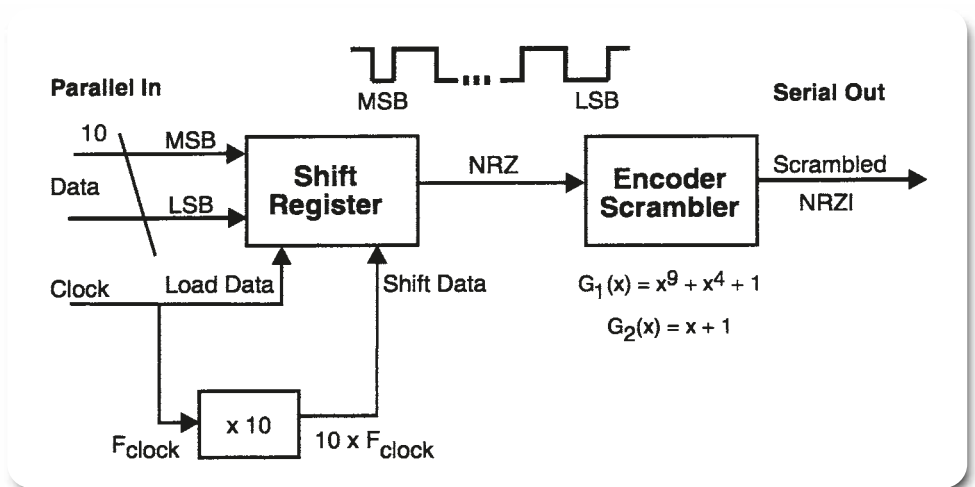

▶ Figure 14. Parallel-to-serial conversion.

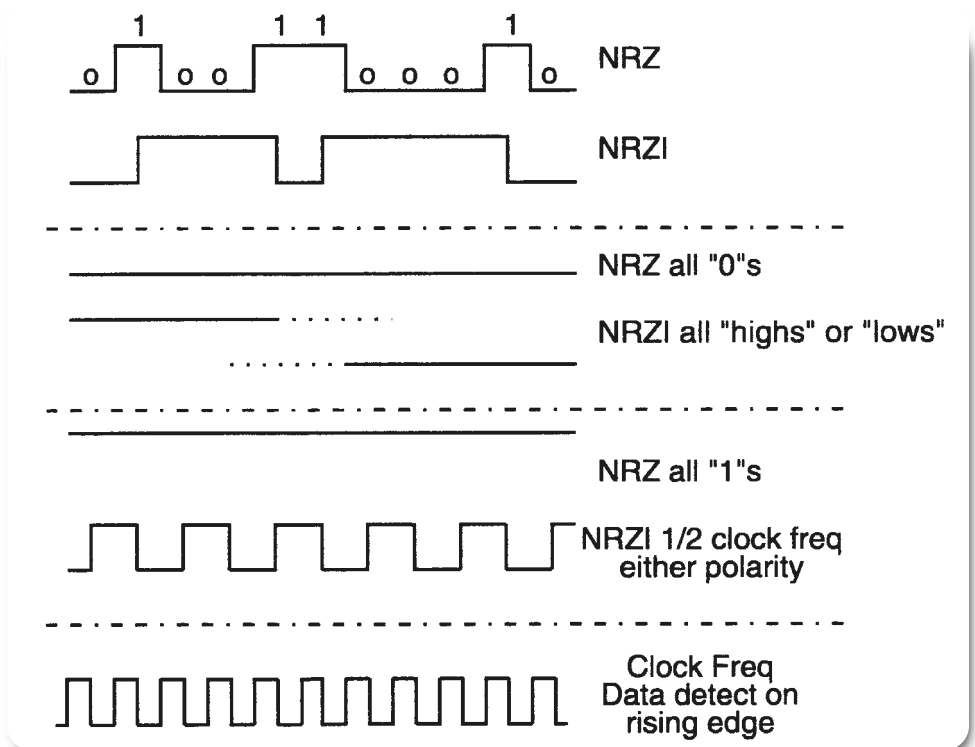

▶ Figure 15. NRZ and NRZI relationship.

with high DC content and minimum transitions to test the effectiveness of the SDI receiver circuitry. A normally operating serial digital system will not fail even when stressed by these difficult signals.

Encoding into NRZI makes the serial data stream polarity insensitive. NRZ (non return to zero) is the familiar logic level, high = “1”, low = “0”. For a transmission system it is convenient not to require a certain polarity of signal at the receiver. As shown in Figure 15, a data transition is used to represent each data “1” and there is no transition for a data “0”. The result is that it is only necessary to detect transitions; either polarity of the signal may be used. Another result of NRZI encoding is that a signal of all “1”s now produces a transition every clock interval and results in a square wave at one-half the clock frequency. However, “0”s produce no transition, which leads to the need for scrambling. At the receiver, the rising edge of a square wave at the clock frequency would be used for data detection.

The serial digital interface may be used over moderate distances in a well-designed system with normal 75-ohm video cables, connectors, and patch panels. As an example, the effects of an unterminated cable, such as may be found on a T-connector, may be unnoticeable with analog video but will cause substantial reflections and potential program loss with serial digital video.

This discussion of component video in the parallel and serial domain is generally applicable to both standard definition and high-definition scanning formats. Sampling and quantization levels are generally the same, as is the formatting of synchronizing information. Sampling rates are higher, and there are generally more samples available for ancillary data in high-definition formats. Line numbering and error-check words are present in high-definition formats, and there are more samples available for multi-channel audio. The principles, however, are the same for standard and high-definition formats. Understanding one component digital format puts us well on our way to understanding all of the others. This primer will point out differences as the discussion continues. Digital standard and high-definition video scanning formats are discussed and compared in the Timing and Synchronization section of this primer.

### High-definition video builds on standard definition principles

In transitioning to digital high-definition we can use the basic principles learned for standard definition and apply them to the specific requirements of HDTV. The way we sample the analog signal is the same in principle; we just use higher channel bandwidths and sample rates. The way we process the digital signal is the same in principle; we just handle higher data rates, and take greater care with system design. Everything along the line operates at faster data rates and higher bandwidths, but almost every principle is familiar.

There are a wide variety of formats within high-definition television. This gives the broadcast engineer a wide range of flexibility, but it seemingly increases the complexity of the broadcast system.

Standards define the scanning format, analog interface, parallel digital interface, and the serial digital interface for creating and handling high-definition video. Key standards of interest include:

- **ANSI/SMPTE 240M, Television – Signal Parameters – 1125-Line High-Definition Production Systems.** Defines the basic characteristics of analog video signals associated with origination equipment operating in 1125 (1035 active) production systems at 60 Hz and 59.94 Hz field rates.
- **SMPTE 260M, Television – Digital Representation and Bit-Parallel Interface – 1125/60 High Definition Production System.** Defines the digital representation of 1125/60 high-definition signal parameters defined in analog form by ANSI/SMPTE 240M.
- **ANSI/SMPTE 274M, Television – 1920 x 1080 Scanning and Analog and Parallel Digital Interfaces for Multiple Picture Rates.** Defines a family of scanning systems having an active picture area of 1920 pixels by 1080 lines and an aspect ratio of 16:9.
- **ANSI/SMPTE 292M, Television – Bit-Serial Digital Interface for High-Definition Television Systems.** Defines the bit-serial digital coaxial and fiber-optic interface for high-definition component signals operating at 1.485 Gb/s and 1.485/1.001 Gb/s.
- **ANSI/SMPTE 296M-1997, Television – 1280 x 720 Scanning, Analog and Digital Representation and Analog Interface.** Defines a family of progressive scan formats having an active picture area of 1280 pixels by 720 lines and an aspect ratio of 16:9.

Typical analog video bandwidth of high-definition video red, green, and blue components is 30 MHz for 1080 interlaced scan and 720 progressive scan formats and 60 MHz for a 1080 progressive format. Therefore, a high sample rate is required to digitize the matrixed luma and color-difference signals. The sample rate for the 30 MHz luma Y channel is 74.25 MHz and half that rate, 37.125 MHz, is used to sample each of the 15 MHz color-difference signals C'b and C'r. The signals are sampled with 10 bits of resolution. C'b and C'r are matrixed into a single stream of 10-bit parallel data at 74.25 MB/s, then matrixed with the 74.25 MB/s luma data creating a 10-bit parallel data stream at 148.5 MB/s in word order C'b, Y', C'r, Y', the same as standard definition. Just as in standard definition, the parallel data is then serialized, in this case, to a scrambled, NRZI, 1.485 Gb/s data stream for transmission within the studio plant.

Chroma and luma quantization (refer back to Figures 9 and 10) is the same for standard definition and high-definition signals and decimal 10-bit codewords 0, 1, 2, 3 and 1020, 1021, 1022, and 1023 are still excluded values. The codewords for EAV and SAV have the same functionality for standard and high-definition. Additional words follow EAV and SAV in high-definition formats to number individual lines and provide line-by-line error checking of luma and the two color-difference channels.

Formatting of data in the video line is shown in Figure 16, which also illustrates the timing relationship with analog high-definition video.

In high-definition formats, the four word EAV sequence is immediately followed by a two-word line number (LNO and LN1); followed by a two word CRC (YCRO and YCR1). The first of these is a line counter which is an 11-bit binary value distributed in two data words, LNO and LN1, as shown in Table 3. For example, for line 1125, the two data words would have the value  $LNO = 394_n$  and  $LN1 = 220_n$ , for a binary data word 10001100101.

Table 3. Bit Distribution of Line Number Word

Word	9 (MSB)	8	7	6	5	4	3	2	1	0 (LSB)
LNO	Not B8	L6	L5	L4	L3	L2	L1	L0	R (0)	R (0)
LN1	Not B8	R (0)	R (0)	R (0)	L10	L9	L8	L7	R (0)	R (0)

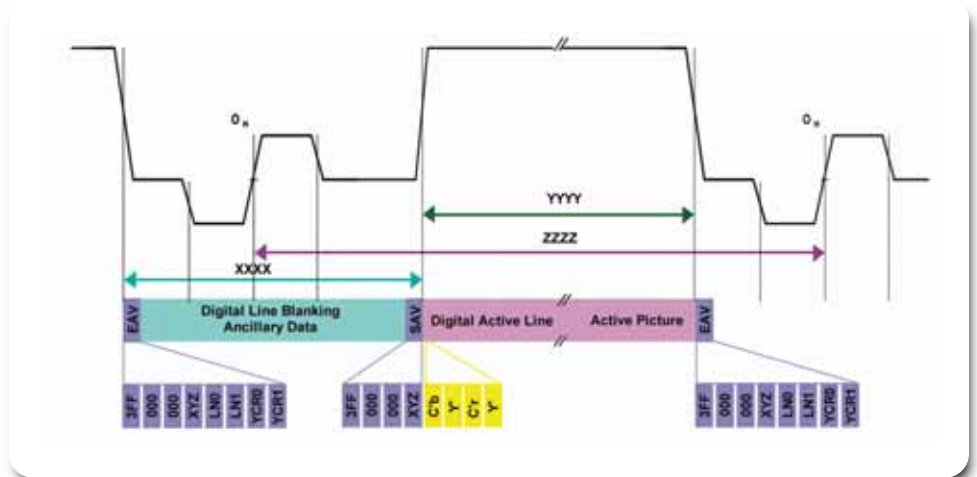

▶ Figure 16. Ancillary data in the digital line vs. analog representation.

CRC checking, in high definition, is done separately for luma and chroma on each line. A CRC value is used to detect errors in the digital active line by means of the calculation  $CRC(X) = X18 + X5 + X4 + 1$  with an initial value of zero at the start of the first active line word and ends at the final word of the line number. The value is then distributed as shown in Table 4. A value is calculated for luma YCRO and YCR1 and another value, CCR0 and CCR1, is calculated for color-difference data.

# A Guide to Standard and High-Definition Digital Video Measurements

## ► Primer

Luma and chroma CRC values can be displayed on the measurement instrument and used for determination of any errors accumulating within the signal as it travels from point to point.

In standard definition formats, EAV ends with the xyz word; there is no line numbering. A CRC for active picture, and a CRC for the complete field (excluding the time set aside for vertical interval signal switching), is optionally done once per field in the vertical blanking interval as described in SMPTE RP-165.

All words in the digital line horizontal blanking area between EAV and SAV (Figure 17) are set to black ( $Y' = 040_H$ ,  $C'b$  and  $C'r = 200_H$ ) if not used for ancillary data.

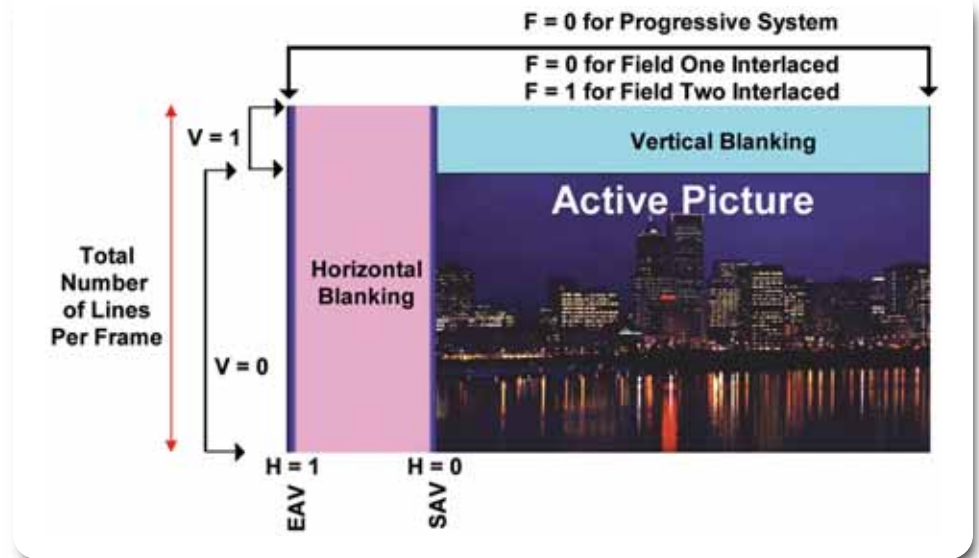

► **Figure 17.** Spatial layout of the digital frame with V, F, and H-bit values.

**Table 4.** Bit Distribution of Words Making Up Luma and Chroma CRCs in High-Definition Formats

Word	9 (MSB)	8	7	6	5	4	3	2	1	0 (LSB)
YCRO	Not B8	CRC8	CRC7	CRC6	CRC5	CRC4	CRC3	CRC2	CRC1	CRC0
YCR1	Not B8	CRC17	CRC16	CRC15	CRC14	CRC13	CRC12	CRC11	CRC10	CRC9
CCRO	Not B8	CRC8	CRC7	CRC6	CRC5	CRC4	CRC3	CRC2	CRC1	CRC0
CCR1	Not B8	CRC17	CRC16	CRC15	CRC14	CRC13	CRC12	CRC11	CRC10	CRC9

## ▶ Timing and Synchronization

Standards provide information that allows interchange and interoperability among the various devices in the end-to-end video chain. Good standards allow economical utilization of resources and technologies. Standards promote cooperation among users and encourage innovation. Standards are necessary if the video professional and the home viewer are to produce and view the same program.

The American National Standards Institute, Society of Motion Picture and Television Engineers, Audio Engineering Society, and International Telecommunications Union publish the reference standards and recommendations for video and audio. Representative standards and recommendations, listed in **Appendix D – Reference Standards for Television**, define signal parameters that allow compatibility and regulatory compliance. Standards issued by these bodies are developed with great care, and are very helpful in describing the precise characteristics of each system. The following discussion is an interpretation of those standards to provide a broad understanding of many different individually standardized formats.

Successful creation, transmission, and recovery of a video picture depend on each device in the system operating in synchronization with every other device. As the television camera detects the value of a picture element at a certain position in the scene, it must somehow identify where that value is to finally be reproduced on the television display. Synchronizing elements tell the camera how to produce a picture in concert with other cameras and sources and tell the receiver how and where to place the picture on the screen when the picture is finally displayed.

The camera and finally the display know how to scan the detector or screen. They just need to know where to start, and how to keep in step. The synchronizing information is refreshed once each horizontal line and once each vertical sweep of the display (two sweeps for each full picture in a 2:1 interlaced format). Inside a large studio plant, synchronizing information is provided by an external master synchronizing generator. In a small

system, one camera may provide synchronizing information for itself and other video sources as well.

### Analog video timing

There are six standard definition composite analog video formats in common use; PAL, PAL-M, PAL-N, NTSC with setup, NTSC without setup, and SECAM. Additionally, some countries permit a wider on-air transmission bandwidth, leaving room for higher video bandwidth. Studio production in SECAM countries is often done in component or PAL, then formatted into SECAM for transmission. SECAM and PAL video formats are similar with the difference primarily in the way the chroma information is modulated onto the luma video.

Studio video is a continuous stream of information that may be used as it occurs, delayed to match other sources, or recorded for playback later. Whenever it moves, it moves in real time, and it must carry along all of the information necessary to create a picture at the destination. Video contains picture information and timing information to properly reproduce the picture. Timing information includes a pattern of regularly occurring horizontal sync pulses or reserved data words that identify each line of video, interrupted by less frequently occurring vertical sync information that instructs the display to start writing the picture at the top of the screen.

In NTSC or PAL composite video formats, video and timing information can be easily observed. A video waveform monitor is equipped with preset sweep rate selections to display video horizontal lines, the horizontal blanking interval, a sweep of all picture lines (vertical rate), or just the lines in the vertical blanking interval. It is important to recognize these displays are all of the same video signal, the difference being when the signal is displayed and for how long each time. In modern terms, composite analog video is a time-division multiplex of luminance video and synchronizing information. The chrominance information is a frequency-division multiplex of the two color-difference channels. Just look for what you want when it occurs.

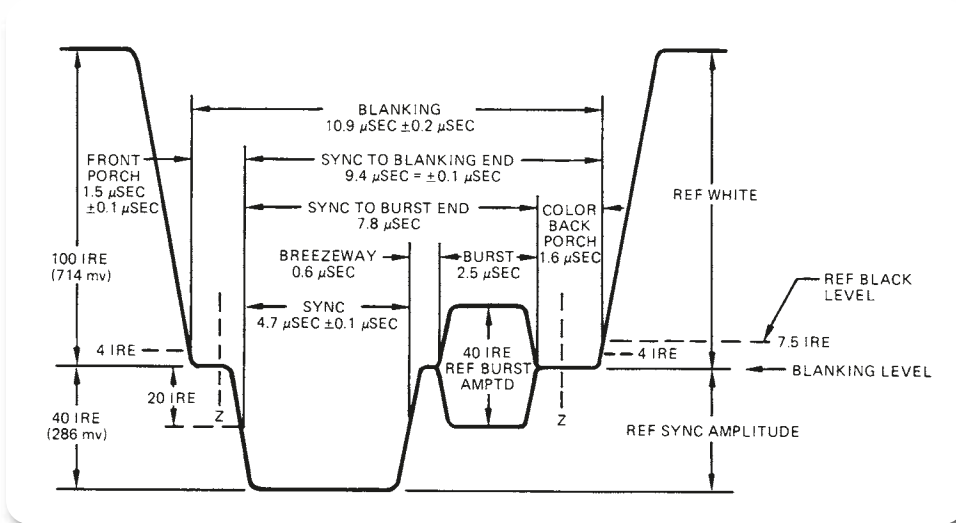

▶ **Figure 18.** NTSC horizontal blanking interval.

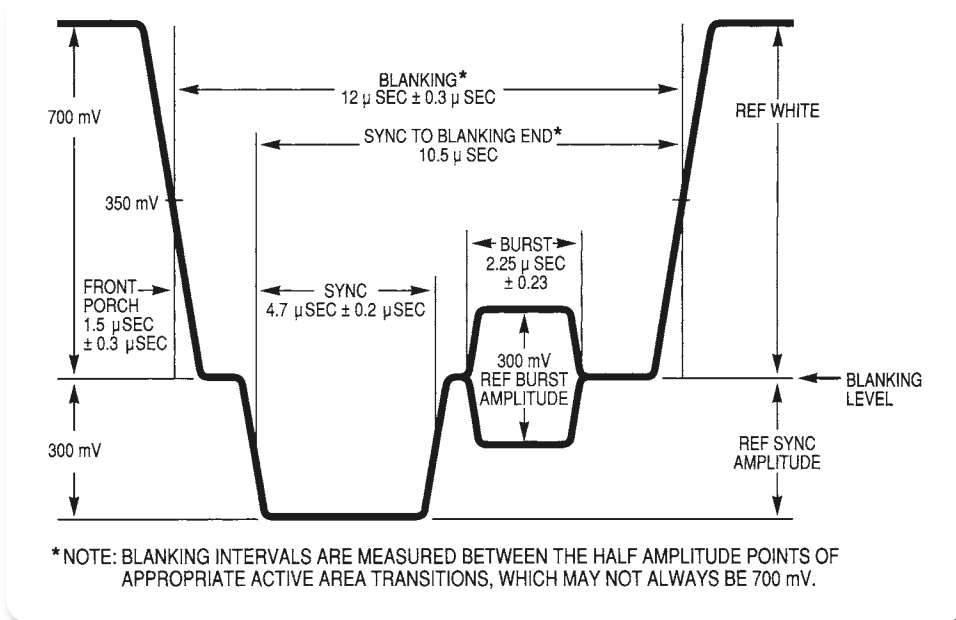

▶ **Figure 19.** PAL horizontal blanking interval.

### Horizontal timing

Horizontal timing diagrams for 525/59.94 NTSC (Figure 18) and 625/50 PAL (Figure 19) scanning formats are similar in concept, and were developed with the constraints of camera and display devices available in the mid 1900's. The horizontal blanking interval occurs once per line of video information and is modified to provide the vertical blanking interval.

The horizontal FRONT PORCH defines a time for the video in each line to end as the beam approaches the right of the screen. The 50% point on the falling edge of the sync pulse, the system timing reference, can then trigger retrace of the picture tube beam. The SYNC TO BLANKING END assures that video won't start illuminating the screen while the beam is still retracing. The REFERENCE WHITE and REFERENCE BLACK levels are specified to assure every program will appear on the display at the same maximum and minimum brightness for a constant contrast without viewer adjustment. The 7.5 IRE difference in setup (the difference in blanking and black levels) in the NTSC format has been the subject of some discussion over the years and some countries operate with no setup. The color subcarrier burst provides a periodic stable reference for synchronizing the receiver color oscillator for stable demodulation of chroma information. Although the subcarrier burst is an eight to ten cycle sample of a constant frequency, the waveform monitor will be locked to the horizontal sync pulse timing reference and the NTSC burst will appear to alternate in phase from line to line and, because of a 25 Hz frequency offset, the

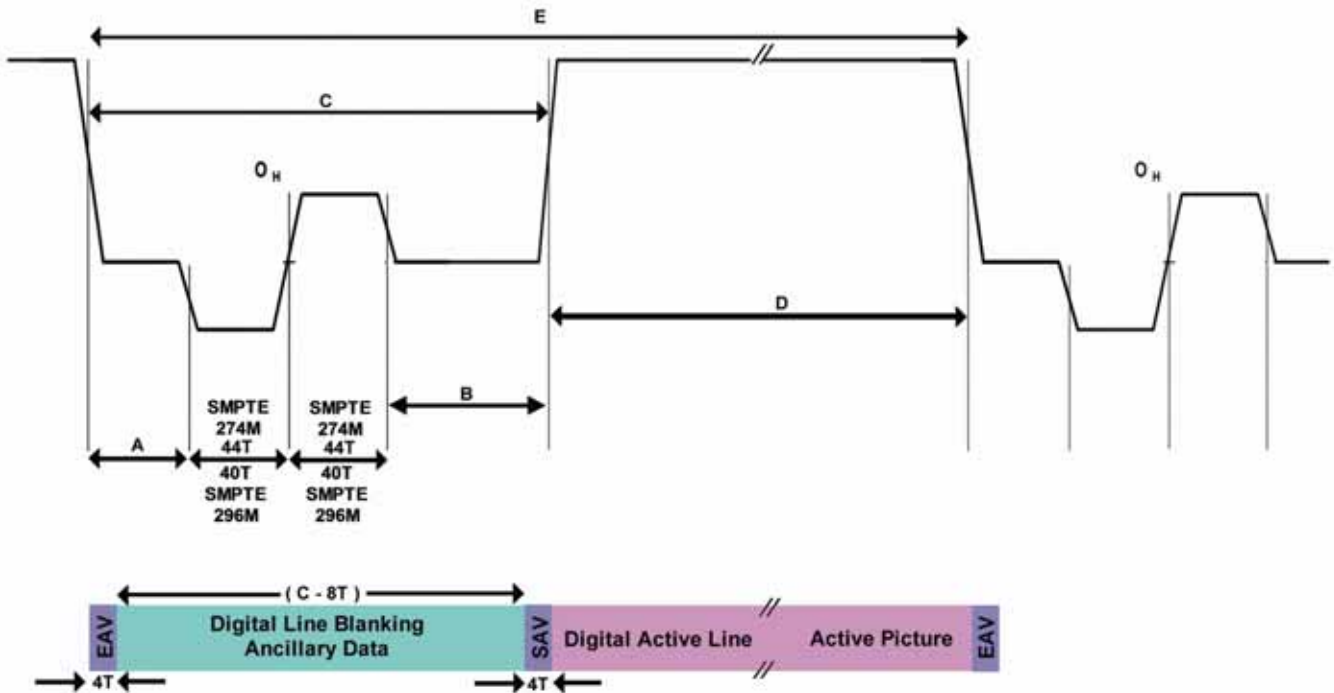

▶ **Figure 20.** High-definition line timing.

PAL burst will appear to be constantly changing. Sync edge timing reference and the color subcarrier burst are individually their own constant phase; they will appear to alternate or be changing because they come into step with each other only periodically.

A line of analog video starts at the 50% point of the falling edge of the bi-level sync pulse and ends at the same point in the next horizontal video line. High-definition analog production formats may use a tri-level sync timing pulse extending first below, then above blanking level. Timing reference,  $O_H$ , for analog tri-level sync is the positive-going transition of the sync waveform through blanking level (Figure 20 and Table 5).

The spatial relationship of the timing signals to the picture time of the video signal is illustrated in Figure 21. For a progressive, 1:1

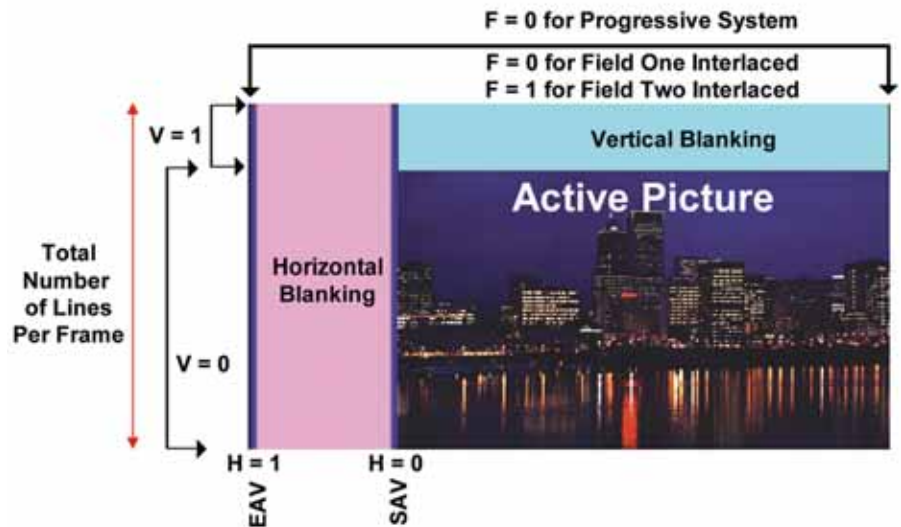

▶ **Figure 21.** Spatial layout of the video frame.



Table 5. High-Definition Line Timing in Sampling Clock Cycles (T)

Format	Sampling Frequency (MHz) (1/T)	A	B	C	D	E
1920x1080 60 1:1	148.5	44T	148T	280T	1920T	2200T
1920x1080 59.94 1:1	148.5/1.001	44T	148T	280T	1920T	2200T
1920x1080 60 2:1	74.25	44T	148T	280T	1920T	2200T
1920x1080 59.94 2:1	74.25/1.001	44T	148T	280T	1920T	2200T
1920x1080 30 1:1	74.25	44T	148T	280T	1920T	2200T
1920x1080 29.97 1:1	74.25/1.001	44T	148T	280T	1920T	2200T
1920x1080 50 1:1	148.5	484T	148T	720T	1920T	2640T
1920x1080 50 2:1	74.25	484T	148T	720T	1920T	2640T
1920x1080 25 1:1	74.25	484T	148T	720T	1920T	2640T
1920x1080 24 1:1	74.25	594T	148T	830T	1920T	2750T
1920x1080 23.98 1:1	74.25/1.001	594T	148T	830T	1920T	2750T
1280x720 60 1:1	74.25	70T	220T	370T	1280T	1650T
1280x720 59.94 1:1	74.25/1.001	70T	220T	370T	1280T	1650T
1280x720 50 1:1	74.25	400T	220T	700T	1280T	1980T
1280x720 30 1:1	74.25	1720T	220T	2020T	1280T	3300
1280x720 29.97 1:1	74.25/1.001	1720T	220T	2020T	1280T	3300
1280x720 25 1:1	74.25	2380T	220T	2680	1280T	3960
1280x720 24 1:1	74.25	2545T	220T	2845	1280T	4125
1280x720 23.98	74.25/1.001	2545T	220T	2845	1280T	4125

format the complete picture (the frame) is scanned from top to bottom, including every picture line in one pass. In interlaced, 2:1 formats, the first pass from top to bottom will write half the lines with each line spaced vertically, and the second pass will be offset to fill in a new field (and complete the frame) between the lines of the previous pass.

### Vertical timing

Vertical timing information is a change in the shape of regularly occurring horizontal synchronizing pulses and addition of equalizing pulses. The vertical blanking interval (Figure 22 NTSC, Figure 23 PAL) is 20 to 25 video lines in time duration and is displayed center screen in the waveform monitor two-field display. The longer vertical blanking time allows the slower vertical return of the picture tube electron beam to the top of the screen.



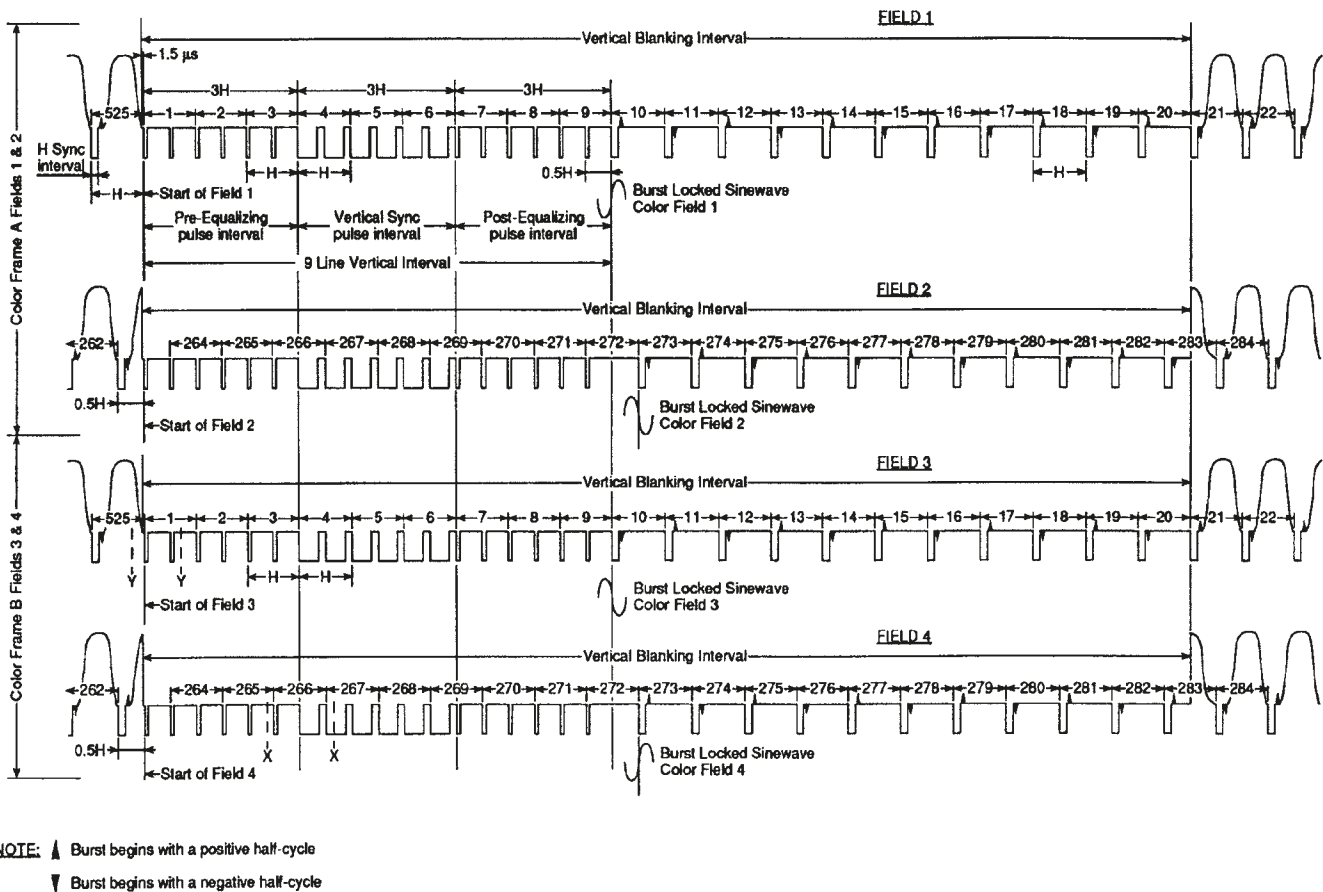

▶ **Figure 22.** NTSC vertical blanking interval.

The different patterns illustrated above and on the next page start the video line at left or middle at the top of the screen to provide a 2:1 interlace of the fields in PAL and NTSC formats. Frequencies are chosen to reduce visibility of the color subcarrier information, which is running at a visible video frequency. It takes eight fields for everything to come to the original phase relationship (a complete color frame) for a PAL signal, four fields for NTSC.

Figure 22 shows the alternating fields, and the four-field NTSC color frame. The color subcarrier comes back into the same relationship with the vertical sync after four fields.

The PAL vertical blanking interval, Figure 23, shows the alternating synchronizing patterns creating the interlaced frame. Because of the 25 Hz offset, the PAL subcarrier phase comes into the same relationship with the vertical sync every eight fields, for an eight-field color frame. SECAM horizontal and vertical sync timing is similar to PAL, but differs in the way chroma is modulated onto the luminance signal.

The phase relationship between the PAL or NTSC vertical sync pattern identifying the correct field, and the color subcarrier phase is important when one source video signal joins or is suddenly replaced by another source, as when video is edited or switched or combined by special effects

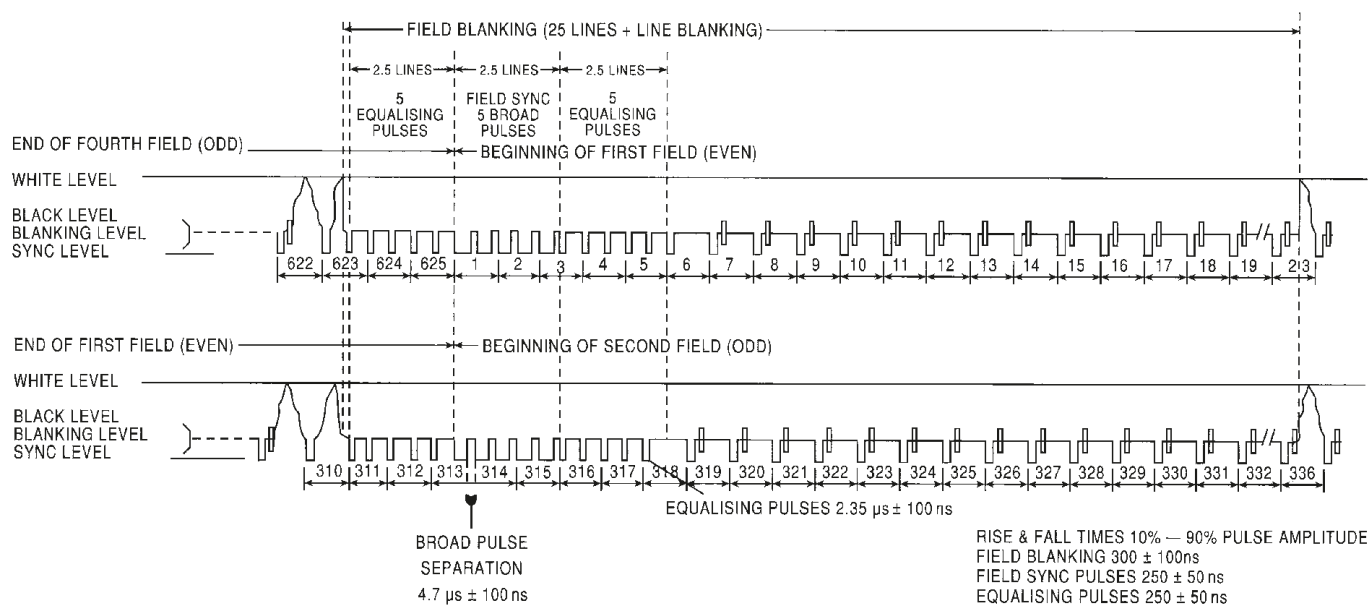

► **Figure 23.** PAL vertical blanking interval.

equipment. This important relationship is referred to as SCH or Subcarrier-to-Horizontal phase. For component video we need only be concerned with the correct positioning of the three channels that make up the color picture as chroma information is not represented by a modulated subcarrier.

Line numbering in NTSC starts with the first vertical equalizing pulse after the last full line of video and continues through each field (263 lines for field one and three, 262 lines for field two and four). Line numbering for PAL and most analog high-definition formats starts with the first broad pulse after the last video half-line and the count continues through the full frame (625 lines for PAL).

In high-definition, there are progressive and interlaced scanning formats as shown in Figure 24. The five lines of the vertical interval broad pulses are slightly different than those of standard definition because of the tri-level sync pulse used in high definition. The progressive format's vertical interval of 1080P (SMPTE 274M) is shown with appropriate line numbers. The interlaced line numbers of the 1080I format (SMPTE 274M) and 1035I format (SMPTE 240M) are shown.



Table 6. Analog High-Definition Timing Parameters with Selected Digital Relationships

	1125/60/2:1 (1125/59.94/2:1)	1250/50/2:1
Sync Type	Tri-level polar	tri-level polar
Horizontal Timing Reference	50% point, rising edge zero crossing	50% point, rising edge zero crossing
Total Lines/Frame	1125	1250
Active Video Lines/Frame	1035	1152
Field Frequency	60 (59.94) Hz	50 Hz
Line Frequency	33.750 (33.71628372) kHz	31.250 kHz
Line Period	29.62962963 (29.65925926) ms	26.00 ms
Line Blanking	3.771 ms	6.00 ms
Timing Reference to SAV	2.586 ms	3.56 ms
Back Porch	–	2.67 ms
EAV to Timing Reference	1.185 ms	1.78 ms
Front Porch	–	0.89 ms
Negative Sync Width	0.593 ms	0.89 ms
Positive Sync Width	0.593 ms	0.89 ms
Sync Amplitude	±300 mV	±300 mV
Sync Rise/Fall	0.054 ms	0.050 ms
Field Pulse	–	8.00 ms
Field Period	20 ms	16.6833 ms
Field Blanking	45 lines	98 lines
Video Signal Amplitude	700 mV	700 mV
Nominal Signal Bandwidth	30 MHz R, G, B	30 MHz R, G, B

## Analog high-definition component video parameters

ANSI/SMPTE 240M defines analog high-definition video in 1125/60(59.94)/2:1 format. ITU-R BT.709 (Part 1) recognizes both 1125/60/2:1 and 1250/50/2:1. These analog rates are shown in Table 6, along with some timings relative to their digital counterparts.

Tektronix has developed a simple proprietary method for timing of an analog and digital facility within the WVR series of waveform rasterizers. The Timing display provides both a simple graphical rectangle window which shows the relative timing between the external reference and input signal and measurement readouts in line and microseconds ( $\mu$ s) of the difference between the two signals as shown in figure 25. The input signal can either be a HD-SDI, SD-SDI or analog composite signal and the input timing is compared to the analog black burst or tri-level sync external reference input.

The rectangle display represents one frame for SDI inputs, or a color frame for composite analog inputs. The cross-hair in the center is zero offset and the circle represent the timing of the input signal. Lines of advance or delay are shown as vertical displacement while timing errors of less than a line are shown as horizontal displacement as shown in figure 26. If the input is at the same time as the reference then the circle will be centered on the cross hair and it will change color from white to green.

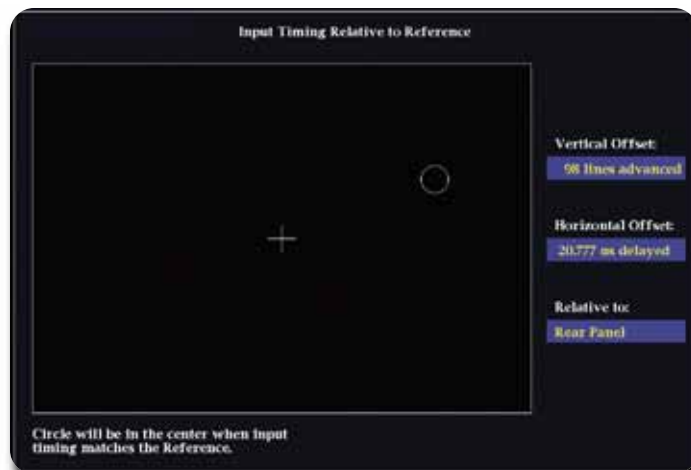

Figure 25. WVR7100 series timing display.

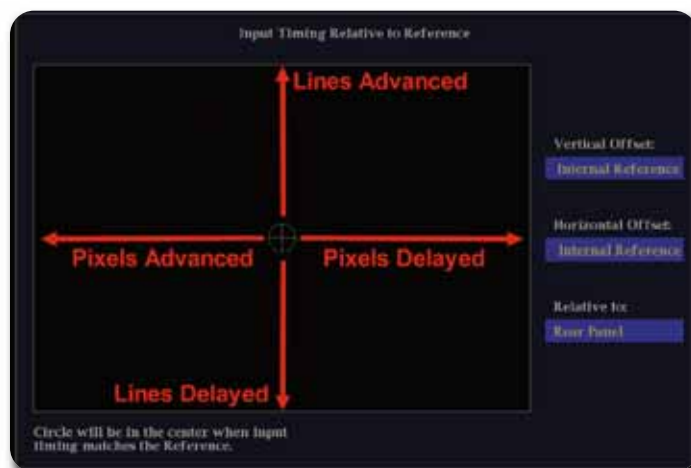

Figure 26. Interpretation of Timing Display.

The Relative to box indicates the chosen zero point for the timing display. The default is the rear panel. In this mode the offset is zero when the input and reference are at the same timing at the rear panel of the instrument. The other choice is to use the Saved offset, in this mode you can save the timing from one of the input signals and then display the timing relative to that saved offset. This is especially useful in timing together the inputs to a router. By selecting one of the inputs to the router as the master and applying this signal to the input along with the external reference signal being used by the router to the WVR series. Once this measurement is obtained save the timing offset for the master input and use the relative to saved offset mode. Now by selecting each of the other inputs to the router via the WVR series the measurement will now show the relative offset between the master reference and the other video inputs. Now simply adjust the horizontal and vertical timing controls of the input signal until the circle and the crosshair are overlaid and the circle turns green. Fine timing adjustment can be done directly from the number readouts of the right hand side of the display. Now each of the inputs to the router is timed relative to the master input signal. This intuitive display can save considerable time in the timing of video systems.

## ▶ Digital Studio Scanning Formats

It is apparent that video scanning standards can be written for a variety of formats. In practice, standards reflect what is possible with the goal of compatibility throughout an industry. At this time there is no one universal scanning format for standard or for high-definition television but there is a trend towards making the television receiver compatible with all of the scanning systems likely to be available within a region. This creates a unique problem for the video professional who must produce programs for a worldwide market.

Some digital rates are particularly well suited to standards conversion. ITU-R BT.709 Part 2 defines a digital, square pixel, common image format (CIF) with common picture parameter values independent of picture rate. This recommendation specifies picture rates of 60, 59.94, 50, 30, 29.97, 25, 24, and 23.976 Hz, all with 1080 active picture lines each with 1920 picture samples and an aspect ratio of 16 wide by 9 high. SMPTE RP 211 extends SMPTE 274M, the 1920x1080 family of raster scanning systems, implementing segmented frames for 1920 x 1080 in 30, 29.97, 25, 24, and 23.976 Hz production formats. These CIF rates are the 1920x1080 rates in Table 7. 1280x720 rates in this table are defined by ANSI/SMPTE 296M. SMPTE 293M defines 720x483 progressive rates. Note that the frame rates and sampling frequencies listed in this table have been rounded to two or three decimal places. For non-integer frame rate systems the exact frame and sampling frequency is the complimentary integer rate divided by 1.001.

### Segmented frame production formats

Several formats in the scanning formats table are nomenclated 1:1SF. The "SF" designates a "segmented frames" format per SMPTE recommended practice RP211. In segmented frame formats, the picture is captured as a frame in one scan, as in progressive formats, but transmitted as in an interlaced format with even lines in one field then odd lines in the next field. The assignment of lines is the same as in an interlaced system, but the picture is captured for both fields in one pass eliminating spatial mis-registration that occurs with movement in an interlaced system. This gives the advantages of progressive scan but reduces the amount of signal processing required and doubles the presentation rate (reducing 24 to 30 Hz visual flicker) in the analog domain. Segmented frame formats may be handled as is, or may be easily converted to progressive formats as shown in Figure 27.

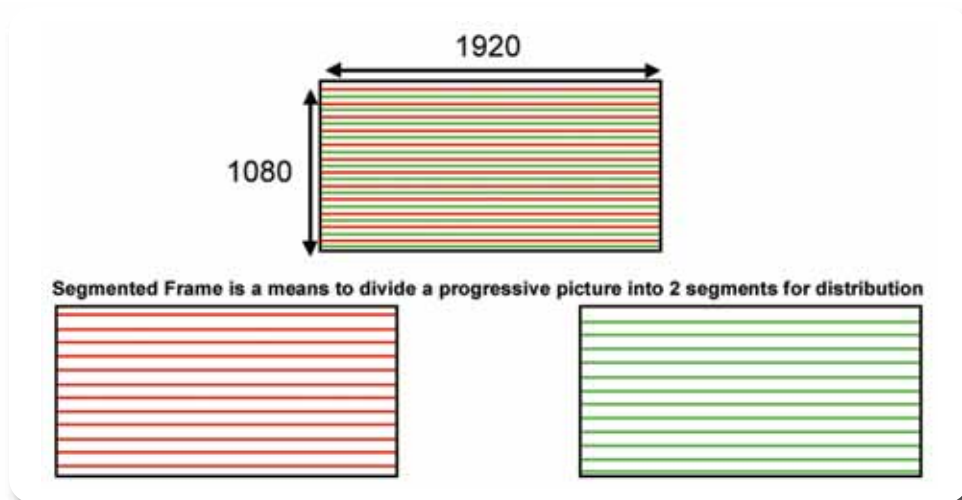

▶ **Figure 27.** Conversion of a progressive frame into segments.

# A Guide to Standard and High-Definition Digital Video Measurements

## ► Primer

Table 7. Scanning Formats for Studio Digital Video

System Nomenclature	Luma or R'G'B' Samples per Active Line	Active Lines per Frame	Frame Rate (Hz)	Scanning Format	Luma or R'G'B' Sampling Frequency (MHz)	Luma Samples per Total Line	Analog Sync Time Ref Word	Total Lines per Frame
1920x1080/60/1:1	1920	1080	60.00	Progressive	148.500	2200	2008	1125
1920x1080/59.94/1:1	1920	1080	59.94	Progressive	148.352	2200	2008	1125
1920x1080/50/1:1	1920	1080	50.00	Progressive	148.500	2640	2448	1125
1920x1080/60/2:1	1920	1080	30.00	2:1 Interlace	74.250	2200	2008	1125
1920x1080/59.94/2:1	1920	1080	29.97	2:1 Interlace	74.176	2200	2008	1125
1920x1080/50/2:1	1920	1080	25.00	2:1 Interlace	74.250	2640	2448	1125
1920x1080/30/1:1	1920	1080	30.00	Progressive	74.250	2200	2008	1125
1920x1080/29.97/1:1	1920	1080	29.97	Progressive	74.176	2200	2008	1125
1920x1080/25/1:1	1920	1080	25.00	Progressive	74.250	2640	2448	1125
1920x1080/24/1:1	1920	1080	24.00	Progressive	74.250	2750	2558	1125
1920x1080/23.98/1:1	1920	1080	23.98	Progressive	74.176	2750	2558	1125
1920x1080/30/1:1SF	1920	1080	30	Prog. SF	74.250	2200	2008	1125
1920x1080/29.97/1:1SF	1920	1080	29.97	Prog. SF	74.176	2200	2008	1125
1920x1080/25/1:1SF	1920	1080	25	Prog. SF	74.250	2640	2448	1125
1920x1080/24/1:1SF	1920	1080	24	Prog. SF	74.250	2750	2558	1125
1920x1080/23.98/1:1SF	1920	1080	23.98	Prog. SF	74.176	2750	2558	1125
1280x720/60/1:1	1280	720	60.00	Progressive	74.250	1650	1390	750
1280x720/59.94/1:1	1280	720	59.94	Progressive	74.176	1650	1390	750
1280x720/50/1:1	1280	720	50.00	Progressive	74.250	1980	1720	750
1280x720/30/1:1	1280	720	30.00	Progressive	74.250	3300	3040	750
1280x720/29.97/1:1	1280	720	29.97	Progressive	74.176	3300	3040	750
1280x720/25/1:1	1280	720	25.00	Progressive	74.250	3960	3700	750
1280x720/24/1:1	1280	720	24.00	Progressive	74.250	4125	3865	750
1280x720/23.98/1:1	1280	720	23.98	Progressive	74.176	4125	3865	750
625/50/2:1 (BT.601)	720	581	25.00	2:1 Interlace	13.500	864	732	625
525/59.94/2:1 (BT.601)	720	483	29.97	2:1 Interlace	13.500	858	736	525
720x483/59.94/1:1/4:2:2	720	483	59.94	Progressive	2 x 13.500	858	736	525
720x483/59.94/1:1/4:2:0	720	483	59.94	Progressive	18.000	858	736	525

► Digital Studio Synchronization and Timing

It is apparent from the review of analog formats that lots of non-video time is assigned just to pass along the synchronizing information and wait for the picture tube to properly retrace the beam. In a digital component studio format, sync is a short reserved-word pattern, and the balance of this time can be used for multi-channel audio, error check sums, and other ancillary data. Using a digital waveform monitor in PASS mode, these short digital timing packets appear to be short pulses at each end of the horizontal line of the decoded video waveform (Figure 28, also see Figure 11). Ringing will appear in the analog representation because the data words occur at the clock rate, well beyond the bandpass of the analog display system. The WFM700M provides a logic level DATA view (Figure 29) of these data words, precisely identifying each word and its value.

It is important to keep several interesting timing definitions in mind when comparing analog and digital video:

1. A line of digital video starts with the first word of the EAV (End of Active Video) data packet, 3FF, and ends with the last word of video data in the line. Digital line numbering starts with the first line of vertical blanking.
2. The sample numbers in the digital video line start (sample 0) with the first word of active video, which is the first word after the four-word of the SAV sequence. So the line number does not change at the same time as the sample number goes back to zero.
3. Unlike digital timing, the analog line starts and ends at the timing reference point; the 50% point of the leading edge of bi-level sync, or the positive-going zero crossing for tri-level sync. The analog timing reference, then, is after the digital timing reference and before the digital line first sample, during the time allocated for ancillary data when the signal is digitized. The digital sample word corresponding to the analog timing reference is specified by the digital standard.

Digital video synchronization is provided by EAV and SAV sequences which start with a unique three-word pattern: 3FF<sub>h</sub> (all bits in the word set to one), 000<sub>h</sub> (all zeros), 000<sub>h</sub> (all zeros), followed by a fourth “xyz” word with the format described in Table 8.



► Figure 28. 270 Mb/s EAV timing reference packet viewed as an analog luma channel signal.



► Figure 29. 270 Mb/s EAV timing reference packet viewed as multiplexed data.

Table 8. Format of EAV/SAV “xyz” Word

Bit Number	9 (MSB)	8	7	6	5	4	3	2	1	0 (LSB)
Function	Fixed (1)	F	V	H	P3	P2	P1	P0	Fixed (0)	Fixed (0)





► **Figure 30.** “xyz” word binary display.

The “xyz” word is a 10-bit word with the two least significant bits set to zero to survive a translation to and from an 8-bit system. Bits of the “xyz” word have the following functions:

- **Bit 9** – (Fixed bit) always fixed at 1
- **Bit 8** – (F-bit) always 0 in a progressive scan system; 0 for field one and 1 for field two of an interlaced system
- **Bit 7** – (V-bit) 1 in vertical blanking interval; 0 during active video lines
- **Bit 6** – (H-bit) 1 indicates the EAV sequence; 0 indicates the SAV sequence
- **Bits 5, 4, 3, 2** – (Protection bits) provide a limited error correction of the data in the F, V, and H bits
- **Bits 1, 0** – (Fixed bits) set to zero to have identical word value in 10 or 8 bit systems

The xyz word in Figure 30 displays a binary value 1001110100, starting with bit 9, the most significant bit. In this example, bit 8, 7, and 6 indicate

the xyz word is in field one of an interlaced format, in a line of active video, and in an EAV sequence. If we change the waveform monitor to display the next field, the new binary xyz word would be 1101101000, with bit 8 changing to a binary 1. The protection bits 5, 4, 3, and 2 would also change to provide limited error handling of the new binary word.

Several F-bit and V-bit examples following this xyz word pattern are provided in Table 9 and layout of the high-definition vertical interval is illustrated in Figure 31.

Table 9. Vertical Timing Information for the Digital Signal

Format	F = 0	F = 1	V = 1	V = 0
1920x1080P	Always = 0	NA	Lines 1-41, 1122-1125	Lines 42-1121
1280x720P	Always = 0	NA	Lines 1-25, 746-750	Lines 26-745
1920x1080I	Lines 1-563	Lines 564-1125	Lines 1-20, 561-583, 1124-1125	Lines 41-557 603-1120
1035I	Lines 1-563	Lines 564-1125	Lines 1-40, 558-602, 1121-1125	Lines 41-557 603-1120
525/60	Lines 4-255	Lines 1-3, 256-525	Lines 1-19, 264-282	Lines 20-263 283-525
625/50	Lines 1-312	Lines 313-625	Lines 1-22, 311-335, 624-625	Lines 23-310 336-623

1125(1080), 750(720), 525 & 625 Formats

	Field	525 Line	625 Line	1080P Line	1080i Line	1035i Line	720P Line	SAV	EAV	9	F	V	H	P3	P2	P1	P0	1	0
Active Video	1	20-236	23-310	42-1121	21-560	41-557	26-745	200		1	0	0	0	0	0	0	0	0	0
									274	1	0	0	1	1	1	0	1	0	0
Field Blanking	1	4-19 264-265	1-22 311-312	1-41 1122-1125	1-20 561-563	1-40 558-563	1-25 746-750	2A0		1	0	1	0	1	0	1	1	0	0
									2D8	1	0	1	1	0	1	1	0	0	
Active Video	2	283-525	336-623	NA	584-1123	603-1120	NA	310		1	1	0	0	0	1	1	1	0	0
									368	1	1	0	1	1	0	1	0	0	
Field Blanking	2	1-3 266-282	624-625 313-335	NA	1124-1125 564-583	1121-1125 564-602	NA	3B0		1	1	1	0	1	1	0	0	0	0
									3C4	1	1	1	1	0	0	0	1	0	0



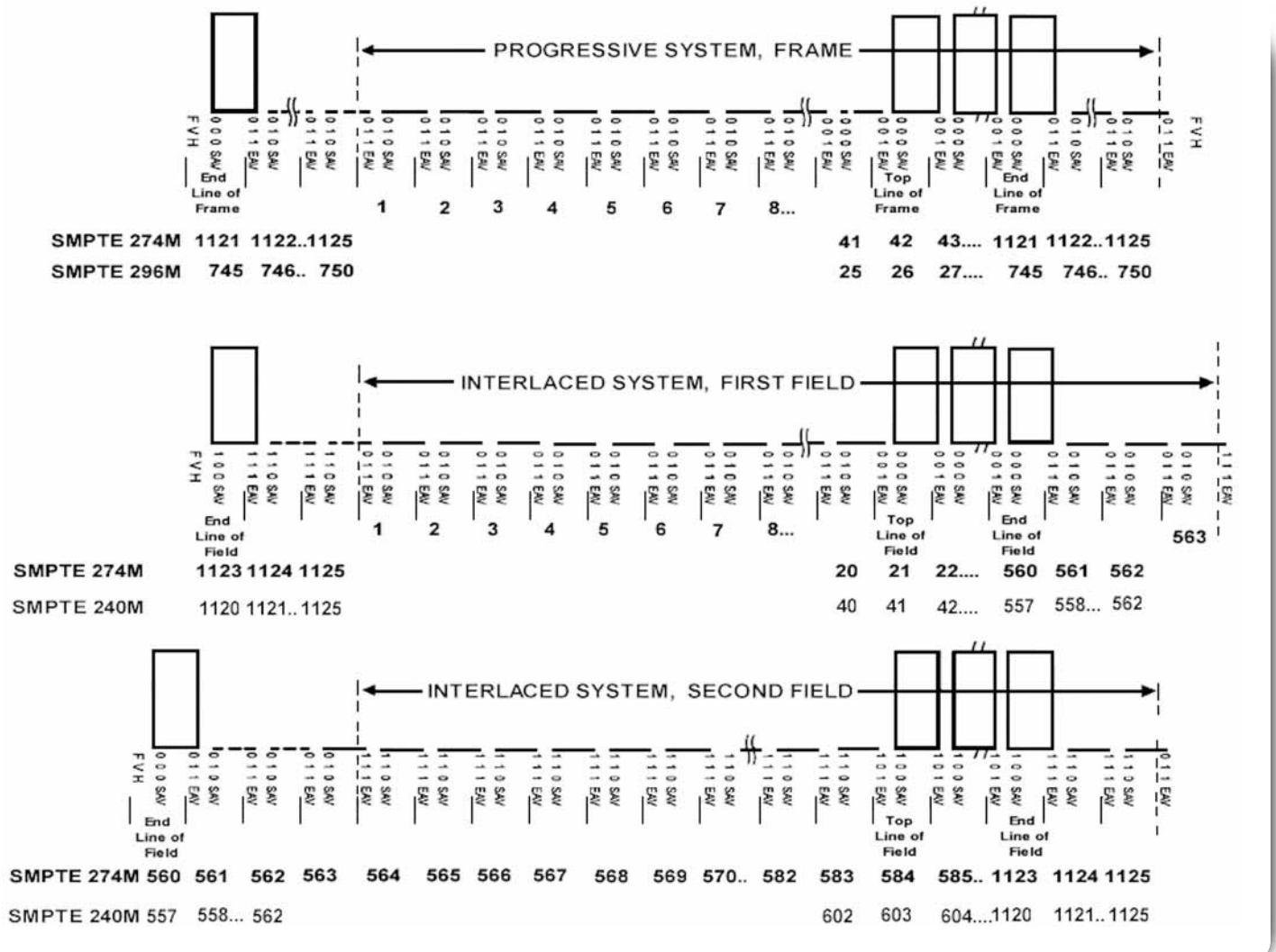

▶ **Figure 31.** High-definition digital vertical timing.

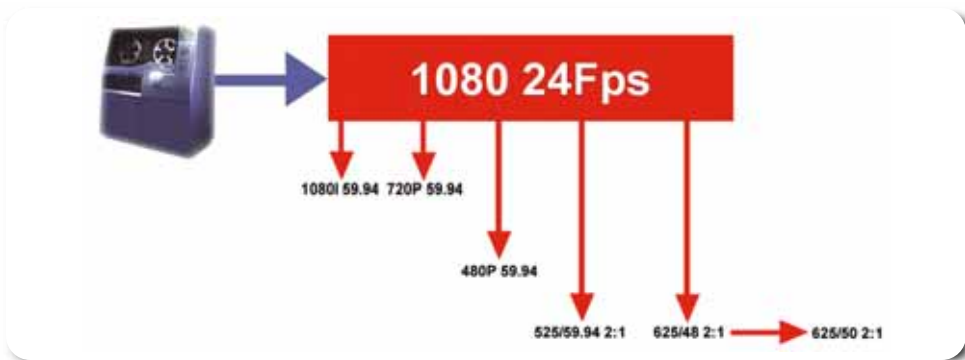

► **Figure 32.** High-definition telecine transfer process.

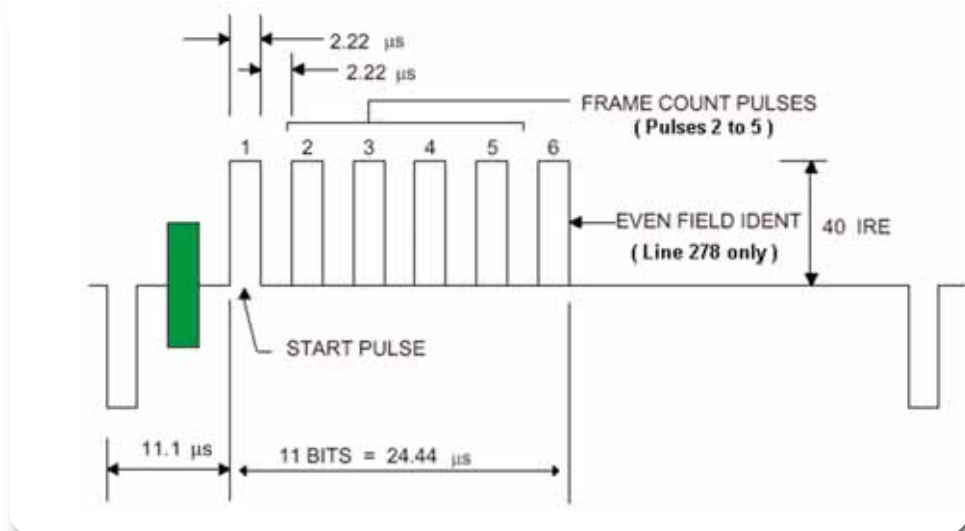

► **Figure 33.** SMPTE 318M timing reference synchronizing line.

Table 10. SMPTE 318M Ten-field Timing Sequence

Ten Field Sequence	Pulse Position						Line Position	
	1	2	3	4	5	6	Line	Field
0	1	0	0	0	0	0	Line15	Field 1
1	1	0	0	0	0	1	Line 278	Field 2
2	1	1	0	0	0	0	Line15	Field 1
3	1	1	0	0	0	1	Line 278	Field 2
4	1	1	1	0	0	0	Line15	Field 1
5	1	1	1	0	0	1	Line 278	Field 2
6	1	1	1	1	0	0	Line15	Field 1
7	1	1	1	1	0	1	Line 278	Field 2
8	1	1	1	1	1	0	Line15	Field 1
9	1	1	1	1	1	1	Line 278	Field 2

### Telecine synchronization

The transition to high-definition video has provided several useful formats for the mastering and archiving of program material. For example, 1080 progressive at 23.976 Hz provides a means for a direct transfer of film frames to digital files. The colorist only has to produce one master during the telecine transfer process. This digital master can then be converted to any other of the required distribution formats.

In order to synchronize this multiformat system, the standard reference used is NTSC black burst with a field frequency of 59.94 Hz. In order to synchronize with equipment operating at 23.976 Hz (24/1.001) or 48 kHz, the black burst signal may carry an optional ten-field sequence for identification of the signal as specified in SMPTE 318M.

The timing reference synchronizing line is shown in Figure 33 and is inserted on line 15 and 278 of a NTSC 525/59.94 Hz signal. The first pulse (1) is always present at the start of the ten-field identification sequence. Pulses (2-5) which are between 0 and four-frame count pulses follow this. The end pulse (6) is always absent on line 15 and always present on line 278. Table 10 summarizes this information.

The Sony/Tektronix TG700 signal generator platform provides the ability to genlock to SMPTE 318M with the AGL7 analog genlock module and provides SMPTE 318M output references with the BG7 black burst generator with CB color bar option.

▶ Digital Audio

One of the advantages of the digital interface is the ability to embed (multiplex) several channels of digital audio into the digital video. This is particularly useful in large systems where separate routing of digital audio becomes a cost consideration and the assurance that the audio is associated with the appropriate video is an advantage. In smaller systems, such as a post production suite, it is generally more economical to maintain separate audio thus eliminating the need for numerous multiplexer and demultiplexer modules. Handling of digital audio is defined in ANSI/SMPTE Standard 272M, Formatting AES/EBU Audio and Auxiliary Data into Digital Video Ancillary Data Space, for 525/60 and 625/50 ANSI/SMPTE 259M formats, and in ANSI/SMPTE 299M, 24-Bit Digital Audio Format for HDTV Bit-Serial Interface for ANSI/SMPTE 292M formats.

From two to sixteen AES/EBU audio channels are transmitted in pairs and combined where appropriate into groups of four channels. Each group is identified by a unique ancillary data ID. Audio is sampled at a video synchronous clock frequency of 48 kHz, or optionally at a synchronous or asynchronous rates from 32 kHz to 48 kHz.

Ancillary data is formatted into packets prior to multiplexing it into the video data stream as shown in Figure 34. Each data block may contain up to 255 user data words provided there is enough total data space available to include the seven (for component video) words of overhead. For composite digital, only the vertical sync broad pulses have enough room for the full 255 words. Multiple data packets may be placed in individual data spaces.

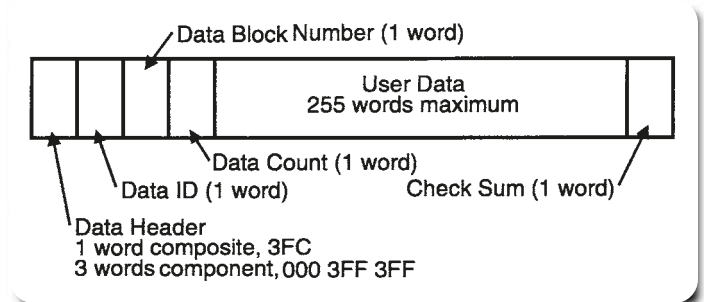

▶ Figure 34. Ancillary data formatting.

At the beginning of each data packet is a header using word values that are excluded for digital video data and reserved for synchronizing purposes. For component video, a three word header  $000_h, 3FF_h, 3FF_h$  is used. Each type of data packet is identified with a different Data ID word. Several different Data ID words are defined to organize the various data packets used for embedded audio. The Data Block Number (DBN) is an optional counter that can be used to provide sequential order to ancillary data packets allowing a receiver to determine if data is missing. As an example, with embedded audio, an interruption in the DBN sequence may be used to detect the occurrence of a vertical interval switch, thereby allowing the receiver to process the audio data to remove the likely transient “click” or “pop”. Just prior to the data is the Data Count word indicating the amount of data in the packet. Finally, following the data is a checksum that is used to detect errors in the data packet.

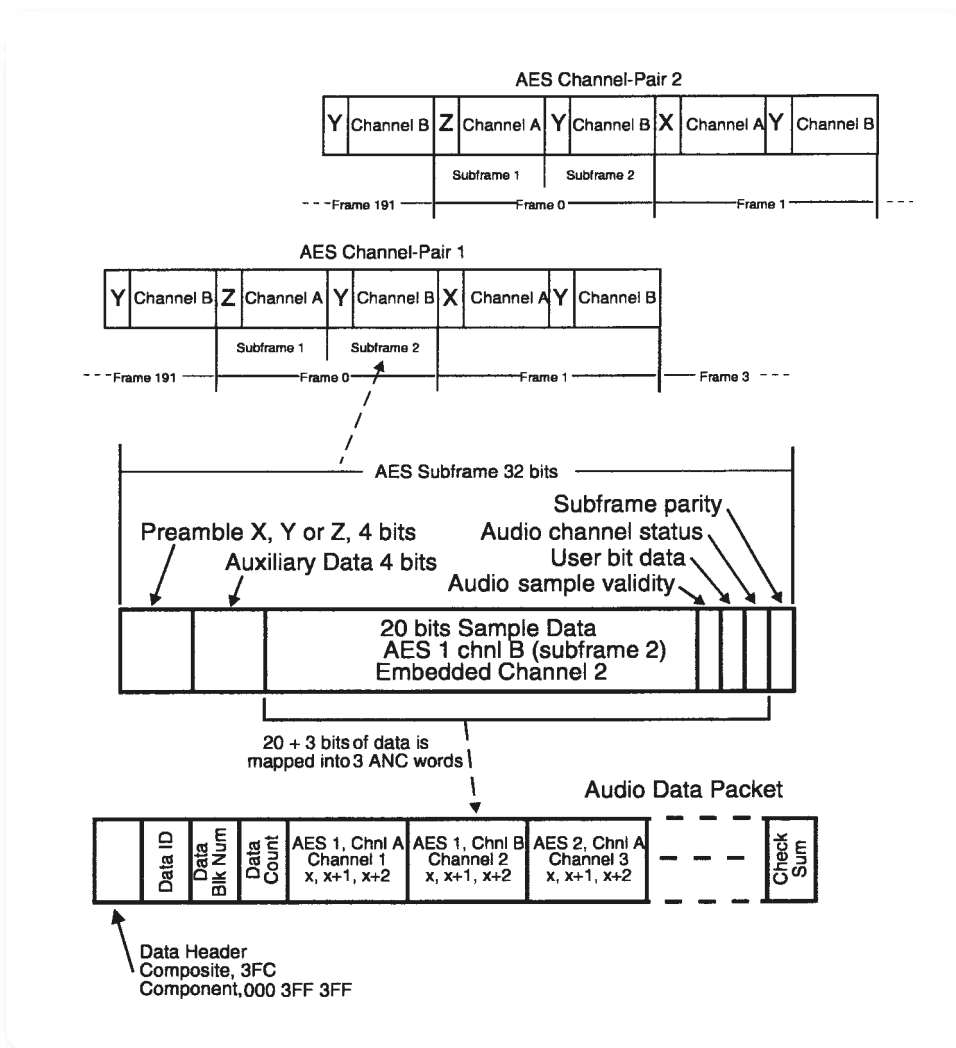

► **Figure 35.** Basic embedded audio.

**Table 11.** Embedded Audio Bit Distribution

Bit	X	X + 1	X + 2
b9	not b8	not b8	not b8
b8	aud 5	aud 14	Parity
b7	aud 4	aud 13	C
b6	aud 3	aud 12	U
b5	aud 2	aud 11	V
b4	aud 1	aud 10	aud 19 (msb)
b3	aud 0	aud 9	aud 18
b2	ch bit-1	aud 8	aud 17
b1	ch bit-2	aud 7	aud 16
B0	Z-bit	aud 6	aud 15

### Embedded audio in component digital video

Embedded audio and available options are defined in ANSI/SMPTE Standard 272M for standard definition and ANSI/SMPTE 299M for high-definition studio digital formats. Please refer to the most current version of those documents. A basic embedded audio configuration with two AES channel-pairs as the source is shown in Figure 35.

The Audio Data Packet contains one or more audio samples from up to four audio channels. 23 bits (20 audio bits plus the C, U, and V bits) from each AES sub-frame are mapped into three 10-bit video words (X, X+1, X+2) as shown in Table 11.

Bit-9 is always the inverse of bit-8 to ensure that none of the excluded word values (3FF<sub>n</sub> through 3FC<sub>n</sub> or 003<sub>n</sub> through 000<sub>n</sub>) are used. The Z-bit is set to “1” corresponding to the first frame of the 192-frame AES block. Channels of embedded audio are essentially independent (although they are always transmitted in pairs) so the Z-bit is set to a “1” in each channel even if derived from the same AES source. C, U, and V bits are mapped from the AES signal; however the parity bit is not the AES parity bit. Bit-8 in word X+2 is even parity for bits 0-8 in all three words.

There are several restrictions regarding distribution of the audio data packets although there is a “grandfather clause” in the standard to account for older equipment that may not observe all the restrictions. Audio data packets are not transmitted in the horizontal ancillary data space following the normal vertical interval switch as defined in RP 168. They are also not transmitted in the ancillary data space designated for error detection checkwords defined in RP 165. Taking into account these restrictions, data should be distributed as evenly as possible throughout the video field. This is important to minimize receiver buffer size for transmitting 24-bit audio in composite digital systems. This results in either three or four audio samples in each audio data packet.

### Extended embedded audio

Full-featured embedded audio is defined in the above standards to include:

- ▶ Carrying the 4 AES auxiliary bits (which may be used to extend the audio samples to 24-bit)
- ▶ Allowing non-synchronous clock operation
- ▶ Allowing sampling other than 48 kHz
- ▶ Providing audio-to-video delay information for each channel
- ▶ Documenting Data IDs to allow up to 16 channels of audio in component digital systems
- ▶ Counting “audio frames” for 525 line systems

To provide these features, two additional data packets are defined. Extended Data Packets carry the 4 AES auxiliary bits formatted such that one video word contains the auxiliary data for two audio samples (Figure 36).

Extended data packets must be located in the same ancillary data space as the associated audio data packets and must follow the audio data packets.

The Audio Control Packet (shown in Figure 37) is transmitted once per field in the second horizontal ancillary data space after the vertical interval switch point. It contains information on audio frame number, sampling frequency, active channels, and relative audio-to-video delay of each channel.

Transmission of audio control packets is optional for 48 kHz synchronous operation and required for all other modes of operation (since it contains the information as to what mode is being used).

Audio frame numbers are an artifact of 525 line, 29.97 frame/second operation. There are exactly 8008 audio samples in five frames, which means there is a non-integer number of samples per frame. An audio frame sequence is the number of frames for an integer number of samples (in this case five) and the audio frame number indicates where in the

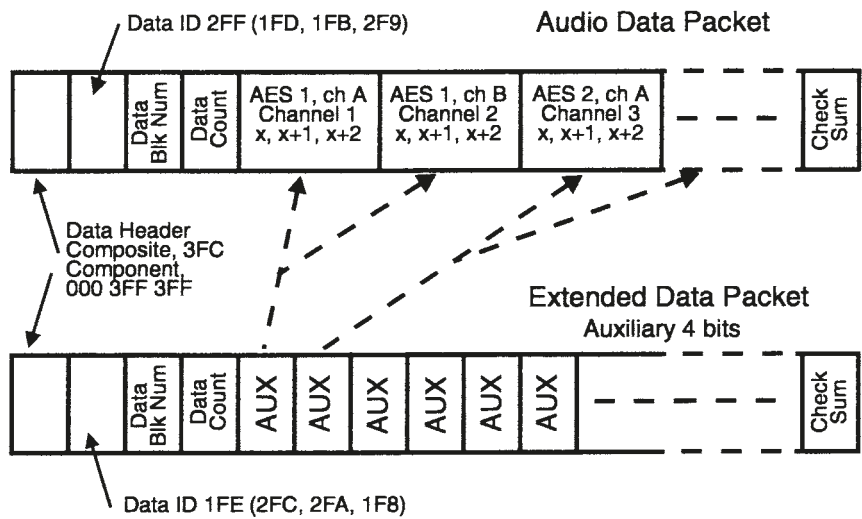

▶ **Figure 36.** Extended embedded audio.

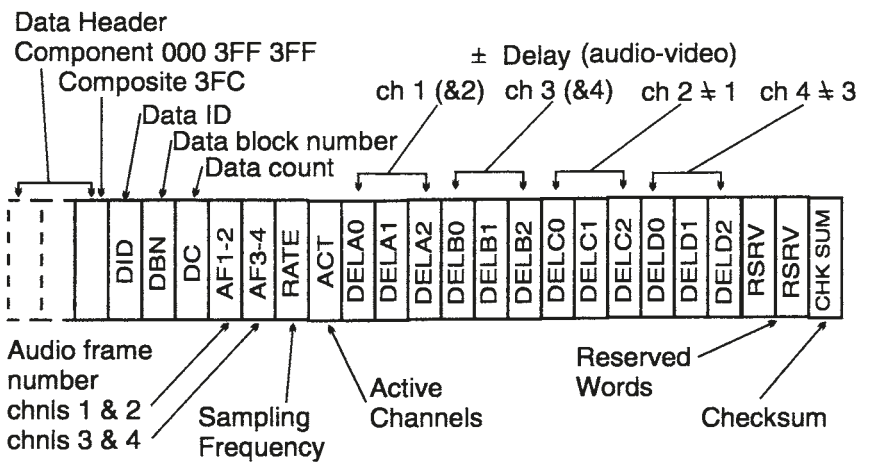

▶ **Figure 37.** Audio control packet formatting.

sequence a particular frame belongs. This is important when switching between sources because certain equipment, most notably digital video recorders, require consistent synchronous operation to prevent buffer over/under flow. Where frequent switching is planned, receiving equipment can be designed to add or drop a sample following a switch in the four out of five cases where the sequence is broken. The challenge in such a system is to detect that a switch has occurred. This can be facilitated by use of the data block number in the ancillary data format structure and by

including an optional frame counter with the unused bits in the audio frame number word of the audio control packet.

Audio delay information contained in the audio control packet uses a default channel-pair mode. That is, delay-A (DELA0-2) is for both channel 1 and channel 2 unless the delay for channel 2 is not equal to channel 1. In that case, the delay for channel 2 is located in delay-C. Sampling frequency must be the same for each channel in a pair, hence the data in "ACT" provides only two values, one for channels 1 and 2 and the other for channels 3 and 4.

In order to provide for up to 16 channels of audio in component digital systems, the embedded audio is divided into audio groups corresponding to the basic four-channel operation. Each of the three data packet types are assigned four data IDs as shown in Table 12.

In component digital video, the receiver buffer in an audio demultiplexer is not a critical issue since there's much ancillary data space available and few lines excluding audio ancillary data. The case is considerably different

## Systemizing AES/EBU audio

Serial digital video and audio are becoming commonplace in production and post-production facilities as well as television stations. In many cases, the video and audio are married sources; and it may be desirable to keep them together and treat them as one data stream. This has, for one example, the advantage of being able to keep the signals in the digital domain and switch them together with a serial digital video routing switcher. In the occasional instances where it's desirable to break away some of the audio sources, the digital audio can be demultiplexed and switched separately via an AES/EBU digital audio routing switcher.

At the receiving end, after the multiplexed audio has passed through a serial digital routing switcher, it may be necessary to extract the audio from the video so that editing, audio sweetening, or other processing can be accomplished. This requires a demultiplexer that strips off the AES/EBU audio from the serial digital video. The output of a typical demultiplexer has a serial digital video BNC as well as connectors for the two-stereo-pair AES/EBU digital audio signals.

Table 12. Data IDs for up to 16-Channel Operation

	Audio Channels	Audio Data Packet	Extended Data Packet	Audio Control Packet
Group 1	1-4	2FF <sub>n</sub>	1FE	1EF
Group 2	5-8	1FD <sub>n</sub>	2FC	2EE
Group 3	9-12	1FB <sub>n</sub>	2FA	2ED
Group 4	13-16	2F9 <sub>n</sub>	1F8	1EC

for composite digital video due to the exclusion of data in equalizing pulses and, even more important, the data packet distribution required for extended audio. For this reason the standard requires a receiver buffer of 64 samples per channel with a grandfather clause of 48 samples per channel to warn designers of the limitations in older equipment.

### Basic HD embedded audio

There are some similarities and several differences in the implementation of AES/EBU within an HD environment. The formatting of the ancillary data packets is the same between SD and HD. The information contained within the user data is different because the full 24bits of audio data are sent as a group and not split-up into 20bits of audio data and an extended packet containing the 4 auxiliary bits. Therefore the total number of bits used in HD is 29 bits (compared with 23bits in SD), the 24 bits of audio data are placed in 4 ancillary data words along with C, V, U and Z-bit flag. Additionally, the CLK and ECC words are added to the packet as shown in Figure 38. Since the full 24 bits of audio data are carried within the user data there is no extended data packet used within HD.

Conformance to the ancillary data packet structure means that the Ancillary Data Flag (ADF) has a 3 word value of  $000_h, 3FF_h, 3FF_h$ , as SMPTE 291M. The one word DID (Data Identification) have the following values to identify the appropriate group of audio data as shown in table 13. DBN is a one word value for data block number and DC is a one word data count which is always  $218_h$ . The User Data Words (UDW) always contains 24 words of data and is structure as shown in Figure 38. The first two words, UDW0 and UDW1 are used for audio clock phase data and provide a means to regenerate the audio sampling clock. The data within these two words provides a count of the number of video clocks between the first word of EAV and the video sample corresponding to the audio sample.

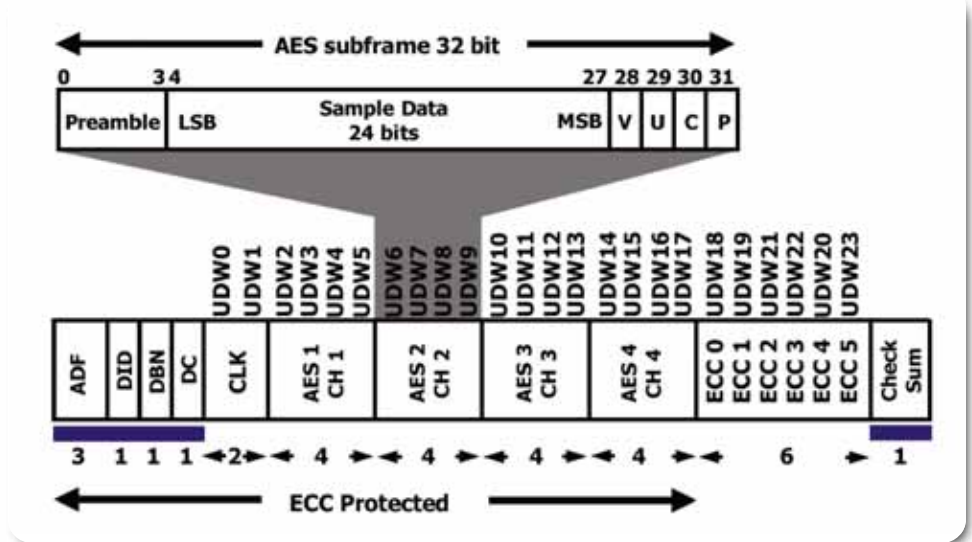

▶ **Figure 38.** Structure of HD audio data packet.

Table 13. Data IDs for up to 16-Channel Operations

	Audio Channels	Audio Data Packet	Audio Control Packet
Group 1	1-4	$2E7_h$	$1E3_h$
Group 2	5-8	$1E6_h$	$2E2_h$
Group 3	9-12	$1E5_h$	$2E1_h$
Group 4	13-16	$2E4_h$	$1E0_h$



# A Guide to Standard and High-Definition Digital Video Measurements

## ▶ Primer

Table 14. Bit Assignment of audio data

Bit	UDW2	UDW3	UDW4	UDW5
B9	NOT B8	NOT B8	NOT B8	NOT B8
B8	EVEN PARITY	EVEN PARITY	EVEN PARITY	EVEN PARITY
B7	AUD1 3	AUD 111	AUD 119	P1
B6	AUD1 2	AUD 110	AUD 118	C1
B5	AUD1 1	AUD 1 9	AUD 1 17	U1
B4	AUD1 0	AUD 18	AUD 116	V1
B3	Z	AUD1 7	AUD1 15	AUD1 23 (MSB)
B2	0	AUD1 6	AUD1 14	AUD1 22
B1	0	AUD1 5	AUD1 13	AUD1 21
B0	0	AUD1 4	AUD1 12	AUD1 20
Bit	UDW6	UDW7	UDW8	UDW9
B9	NOT B8	NOT B8	NOT B8	NOT B8
B8	EVEN PARITY	EVEN PARITY	EVEN PARITY	EVEN PARITY
B7	AUD2 3	AUD 2 11	AUD 219	P2
B6	AUD2 2	AUD 2 10	AUD 218	C2
B5	AUD2 1	AUD 2 9	AUD 2 17	U2
B4	AUD2 0	AUD 2 8	AUD216	V2
B3	0	AUD2 7	AUD2 15	AUD2 23 (MSB)
B2	0	AUD2 6	AUD2 14	AUD2 22
B1	0	AUD2 5	AUD2 13	AUD2 21
B0	0	AUD2 4	AUD2 12	AUD2 20
Bit	UDW10	UDW11	UDW12	UDW13
B9	NOT B8	NOT B8	NOT B8	NOT B8
B8	EVEN PARITY	EVEN PARITY	EVEN PARITY	EVEN PARITY
B7	AUD3 3	AUD 311	AUD 319	P3
B6	AUD3 2	AUD 310	AUD 318	C3
B5	AUD3 1	AUD 3 9	AUD 3 17	U3
B4	AUD3 0	AUD 38	AUD 316	V3
B3 Z	AUD3 7	AUD3 15	AUD3 23 (MSB)	
B2 0	AUD3 6	AUD3 14	AUD3 22	
B1 0	AUD3 5	AUD3 13	AUD3 21	
B0 0	AUD3 4	AUD3 12	AUD3 20	
Bit	UDW14	UDW15	UDW16	UDW17
B9NOT B8	NOT B8	NOT B8	NOT B8	
B8EVEN PARITY	EVEN PARITY	EVEN PARITY	EVEN PARITY	
B7AUD4 3	AUD 4 11	AUD 419	P4	
B6AUD4 2	AUD 410	AUD 418	C4	
B5AUD4 1	AUD 4 9	AUD 4 17	U4	
B4AUD4 0	AUD 4 8	AUD416	V4	
B3 0	AUD4 7	AUD4 15	AUD2 23 (MSB)	
B2 0	AUD4 6	AUD4 14	AUD4 22	
B1 0	AUD4 5	AUD4 13	AUD4 21	
B0 0	AUD4 4	AUD4 12	AUD4 20	

Each audio data subframe is distributed across 4 UDW samples as described in table 14.

Note that the full preamble data is not carried within the 4 words, only a reference to the start of the 192 frame by use of the Z-bit indicator. Also, the parity bit is that used within the 32 bit subframe unlike standard definition.

The Error Correction Codes (ECC) is a set of 6 words that are used to detect errors within the first 24 words from ADF to UDW17. The value is calculated by applying the 8 bits of data B0-B7 of the 24 words through a BCH code information circuit that produces the 6 words of the error correction code.

The ancillary data information is multiplexed within the color difference Cb/Cr data space only. Unlike the standard definition structure which applies the ancillary audio data across CbYCrY\*, the Y data space is only used for the audio control packet that occurs once per field and is placed on the second line after the switching point of the Y data. No ancillary data is placed within the signal on the line subsequent to the switching point. The switching point location is dependent on the format of the high definition signals, for example in the 1125/60 system no ancillary data is put on line 8.



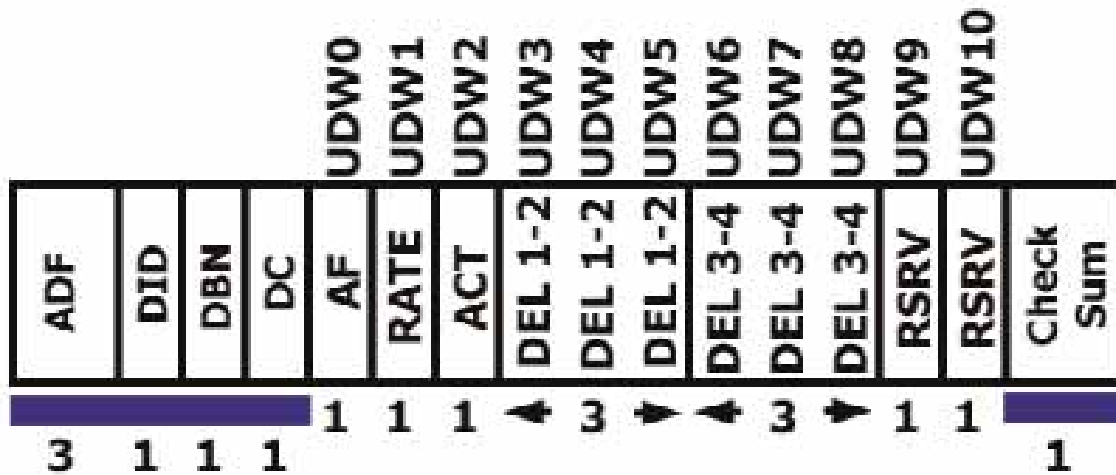

▶ **Figure 39.** Structure of audio control packet.

### Audio Control Packet

The audio control packet carries additional information used in the process of decoding the audio data and has a similar structure to standard definition. Its structure is shown in Figure 39 and contains the following information. The Ancillary Data Flag has a 3 word value of 000h,3FF<sub>n</sub>,3FF<sub>n</sub>. The one word DID have the following values to identify the appropriate group of audio data as shown in table 7. DBN is always 200<sub>n</sub> and DC is always 10B<sub>n</sub>. The UDW contains 11 words of data structured into five different types of data. The audio frame number data (AF) provides a sequential number of video frames to assist in indicating the position of the audio samples when using a non-integer number of audio samples per frame. The one word value RATE indicates the

sampling rate of the audio data and whether the data is synchronous or asynchronous. The ACT word indicates the number of active channels within the group. DELm-n indicates the amount of accumulated audio processing delay relative to video measured in audio sample intervals for each channel pair 1&2 and 3&4.

This is a slightly different format than that used in standard definition. The 2 word value RSRV is reserved for future use at this time.

## ▶ Video Measurements

### Monitoring and measuring tools

We know that digital television is a stream of numbers, and this may lead to some unnecessary apprehension. Everything seems to be happening really fast, and we need some help to sort everything out. Fortunately, video, and especially the ancillary information supporting video, is quite repetitive, so all we need is the hardware to convert this high-speed numeric data to something we can study and understand. Why not just convert it to something familiar, like analog video?

Digital video, either standard definition or the newer high-definition studio formats, is very much the same as its analog ancestor. Lots of things have improved with time, but we still make video with cameras, from film, and today, from computers. The basic difference for digital video is the processing early in the chain that converts the analog video into numeric data and attaches ancillary data to describe how to use the video data. For live cameras and telecine, analog values of light are focused on sensors, which generates an analog response that is converted somewhere along the line to numeric data. Sometimes we can get to this analog signal for monitoring with an analog waveform monitor, but more often the video will come out of the equipment as data. In the case of computer generated video, the signal probably was data from the beginning. Data travels from source equipment to destination on a transport layer. This is the analog transport mechanism, often a wire, or a fiber-optic path carrying the data to some destination. We can monitor this data directly with a high-bandwidth oscilloscope, or we can extract and monitor the data information as video.

Operationally, we are interested in monitoring the video. For this we need a high-quality waveform monitor equipped with a standards-compliant data receiver to let us see the video in a familiar analog format. Tektronix provides several digital input waveform monitors, including the WVR Series (Figure 40) for standard definition/high-definition component digital video and the WFM700 Series (Figure 41) which is configurable for any of the component digital formats in common use today.



▶ **Figure 40.** WVR series standard and high-definition digital waveform monitors.



▶ **Figure 41.** WFM700 standard and high-definition digital waveform monitor.



▶ **Figure 42.** Sony/Tektronix TG700 Signal Generator Platform.

Technically, we may want to know that the camera or telecine is creating correct video data and that ancillary data is accurate. We may also want to evaluate the analog characteristics of the transport layer. The Tektronix VM700T with digital option, the WFM601M, and the WFM700M allow in-depth data analysis and a direct view of the eye-pattern shape of the standard definition transport layer. The new WFM700 series high-definition monitors provide tools for both transport and data layer technical evaluation.

A test signal generator serves two purposes. It provides an ideal-reference video signal for evaluation of the signal processing and transmission path, and it provides an example of the performance you should expect of today's high quality system components. Some generation equipment, such as the Sony/Tektronix TG700 signal generator platform shown in Figure 42, provides options for both analog and digital, standard and high-definition signal formats.

These tools allow an operator to generate video that is completely compatible with the transmission system, video processing devices, and finally with the end viewer's display. Perhaps most important, these tools provide an insight into the workings of the video system itself that increase technical confidence and awareness to help you do your job better.

### Monitoring digital and analog signals

There is a tendency to think of any video signal as a traditional time/amplitude waveform. This is a valid concept and holds for both analog and digital. For analog video, the oscilloscope or waveform monitor displays a plot of signal voltage as time progresses. The waveform monitor is synchronized to show the desired signal characteristic as it occurs at the same horizontal position on the waveform monitor display each time it occurs, horizontally in the line, or vertically in the field. A digital waveform monitor

shows the video information extracted from the incoming data signal in the same manner as the analog waveform monitor. You see the same information in the same way from the analog or digital signals. For analog you see the direct signal; for digital you see the signal described by the data. Operationally you use the monitor to make the same video evaluations.

Additional measurements may be unique to the system being monitored. You may want to demodulate the NTSC or PAL color information for display on an analog vectorscope. You may want to see an X vs. Y display of the color-difference channels of a digital component signal to simulate an analog vector display without creating or demodulating a color subcarrier. You may want to observe the data content of a digital signal directly with a numeric or logic level display. And you will want to observe gamut of the analog or digital signal. Gamut is covered in greater detail in

### Appendix A – Gamut, Legal, Valid.

#### Assessment of video signal degradation

Some of the signal degradations we were concerned with in analog NTSC or PAL are less important in standard definition component video. Degradations become important again for even more basic reasons as we move to high-definition video. If we consider the real analog effects, they are the same. We sought signal integrity in analog to avoid a degradation of color video quality, but in high-definition we can start to see the defect itself.

#### Video amplitude

The concept of unity gain through a system has been fundamental since the beginning of television. Standardization of video amplitude lets us design each system element for optimum signal-to-noise performance and freely interchange signals and signal paths. A video waveform monitor, a specialized form of oscilloscope, is used to measure video amplitude. When setting analog video amplitudes, it is not sufficient to simply adjust the output level of the final piece of equipment in the signal path. Every piece of equipment should be adjusted to appropriately transfer the signal from input to output.

In digital formats, maintenance of video amplitude is even more important. Adequate analog video amplitude into the system assures that an optimum number of quantization levels are used in the digitizing process to reproduce a satisfactory picture. Maintaining minimum and maximum amplitude excursions within limits assures the video voltage amplitude will not be outside the range of the digitizer. Aside from maintaining correct color balance, contrast, and brightness, video amplitude must be controlled within gamut limits legal for transmission and valid for conversion to other video

formats. In a properly designed unity-gain video system, video amplitude adjustments will be made at the source and will be correct at the output.

In the analog domain, video amplitudes are defined, and the waveform monitor configured to a standard for the appropriate format. NTSC signals will be 140 IRE units, nominally one volt, from sync tip to white level. The NTSC video luminance range (Figure 43) is 100 IRE, nominally 714.3 mV, which may be reduced by 53.5 mV to include a 7.5 IRE black level setup. Depending on color information, luminance plus chrominance components may extend below and above this range. NTSC sync is -40 IRE units, nominally -285.7 mV from blanking level to sync tip. The NTSC video signal is generally clamped to blanking level and the video monitor is set to extinguish at black level.

PAL signals are also formatted to one-volt sync tip to white level, with a video luminance range of 700 mV, with no setup. PAL sync is -300 mV. The signal is clamped, and the monitor brightness set to extinguish at black level. Chrominance information may extend above and below the video luminance range.

Video amplitude is checked on a stage-by-stage basis. An analog test signal with low-frequency components of known amplitude (such as blanking and white levels in the color bar test signal) will be connected to the input of each stage and the stage adjusted to replicate those levels at the output stage.

Regulatory agencies in each country, with international agreement, specify on-air transmission standards. NTSC, PAL, and SECAM video transmitters are amplitude-modulated with sync tip at peak power and video white level plus chroma extending towards minimum power. This modulation scheme is efficient and reduces visible noise, but is sensitive to linearity effects. Video levels must be carefully controlled to achieve a balance of economical full-power sync tip transmitter output and acceptable video signal distortion as whites and color components extend towards zero carrier power. If video levels are too low, the video signal/noise ratio suffers and electric power consumption goes up. If video levels are too high, the transmitter performs with greater distortion as the carrier nears zero power, and performance of the inter-carrier television audio receiver starts to fail.

### Signal amplitude

In an analog system, the signal between studio components is a changing voltage directly representing the video. An analog video waveform monitor of the appropriate format makes it easy to view the voltage level of the analog video signal in relation to distinct timing patterns.

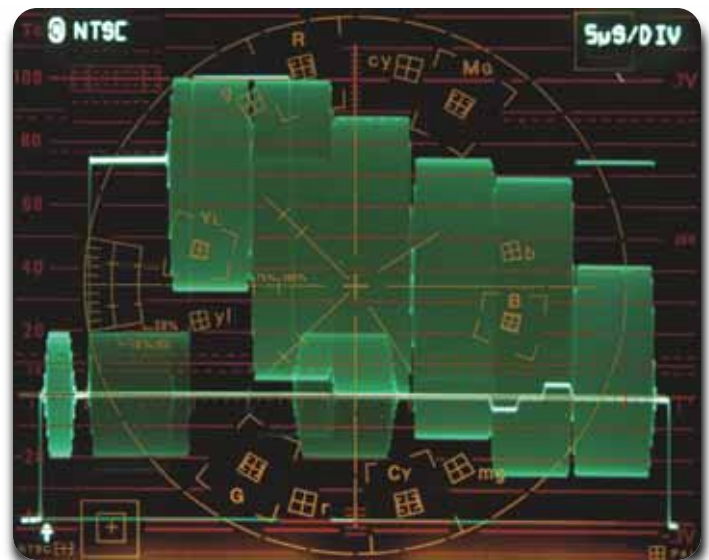

► **Figure 43.** Correctly adjusted composite video amplitude, NTSC, no setup.

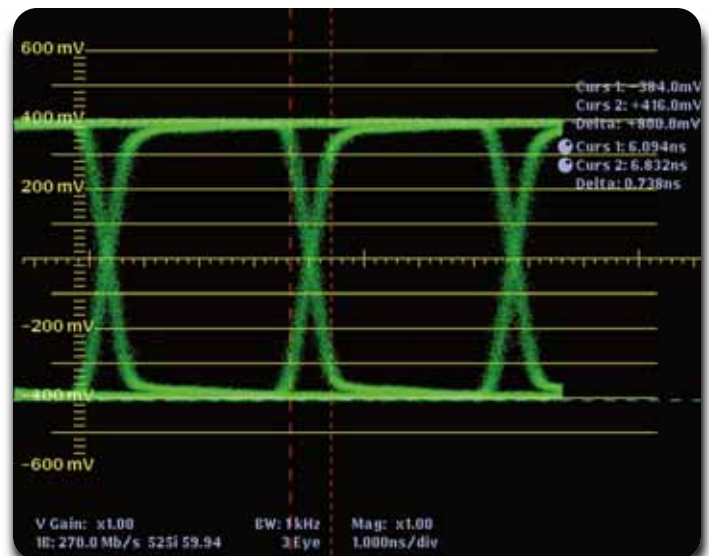

► **Figure 44.** Correct 270 Mb/s data signal viewed with WFM700M.

In a digital video system, the signal is a data “carrier” in the transport layer; a stream of data representing video information. This data is a series of analog voltage changes (Figures 43 and 44) that must be correctly identified as high or low at expected times to yield information on the content. The transport layer is an analog signal path that just carries whatever is input to its destination. The digital signal starts out at a level of 800 mV and its spectral content at half the clock frequency at the destination determines the amount of equalization applied by the receiver.

Digital signals in the transport layer can be viewed with a high-frequency oscilloscope or with a video waveform monitor such as the Tektronix WFM601E or WFM601M for standard definition, or the WFM700M monitor for either standard or high-definition formats. In the eye pattern mode, the waveform monitor operates as an analog sampling oscilloscope with the display swept at a video rate. The equivalent bandwidth is high enough, the return loss great enough, and measurement cursors appropriately calibrated to accurately measure the incoming data signal. The rapidly changing data in the transport layer is a series of ones and zeros overlaid to create an eye pattern. Eye pattern testing is most effective when the monitor is connected to the device under test with a short cable run, enabling use of the monitor in its non-equalized mode. With long cable runs, the data tends to disappear in the noise and the equalized mode must be used. While the equalized mode is useful in confirming headroom, it does not provide an accurate indicator of the signal at the output of the device under test. The WFM601M and WFM700M also provide additional transport layer information such as jitter, rise time, eye opening (extinction ratio), reflections, and data analysis on the received data itself.

Since the data transport stream contains components that change between high and low at rates of 270 Mb/s for standard definition ITU-R BT.601 component video, up to 2.970 Gb/s for some high-definition formats, the ones and zeros will be overlaid (Figure 45) for display on a video waveform monitor. This is an advantage since we can now see the cumulative data over many words, to determine any errors or distortions that might intrude on the eye opening and make recovery of the data high or low by the receiver difficult. Digital waveform monitors such as the Tektronix WFM601E and WFM601M, and the WFM700M series for multiple digital formats provide a choice of synchronized sweeps for the eye pattern display so word, line, and field disturbances may be correlated.

The digital video waveform display that looks like a traditional analog waveform (baseband video) is really an analog waveform recreated by the numeric data in the transport layer. The digital data is decoded into high quality analog component video that may be displayed and measured as an analog signal. Although monitoring in the digital path is the right choice, many of the errors noted in digital video will have been generated earlier in the analog domain.

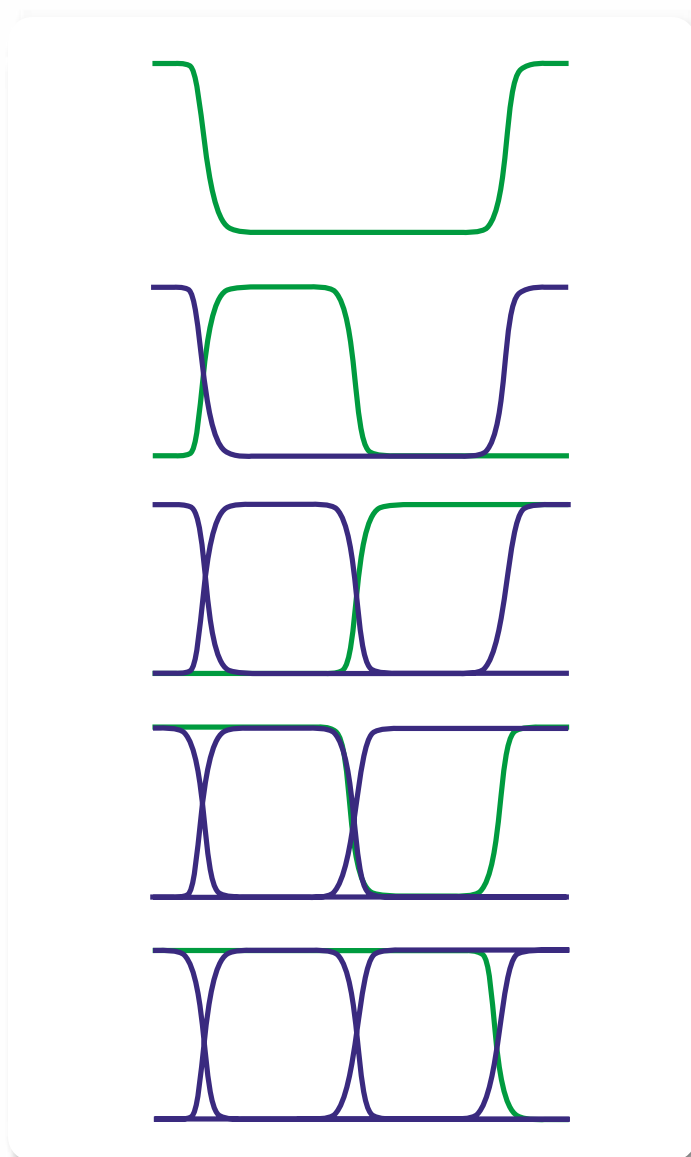

▶ **Figure 45.** *Development of the eye diagram.*



## Frequency response

In an analog video system, video frequency response will be equalized where necessary to compensate loss of high-frequency video information in long cable runs. The goal is to make each stage of the system “flat” so all video frequencies travel through the system with no gain or loss. A multiburst test signal (Figure 46) can be used to quickly identify any required adjustment. If frequency packets in the multiburst signal are not the same amplitude at the output stage (Figure 47), an equalizing video distribution amplifier may be used to compensate, restoring the multiburst test signal to its original value.

In a digital system, high-frequency loss affects only the energy in the transport data stream (the transport layer), not the data numbers (the data layer) so there is no effect on video detail or color until the high-frequency loss is so great the data numbers cannot be recovered. The equalizer in the receiver will compensate automatically for high-frequency losses in the input. The system designer will take care to keep cable runs short enough to achieve near 100% data integrity and there is no need for frequency response adjustment. Any degradation in video frequency response will be due to analog effects.

## Group delay

Traditional analog video designs, for standard definition systems, have allowed on the order of 10 MHz bandwidth and have provided very flat frequency response through the 0-6 MHz range containing the most video energy. Group-delay error, sometimes referred to as envelope delay or frequency-dependent phase error, results when energy at one frequency takes a longer or shorter time to transit a system than energy at other frequencies, an effect often associated with bandwidth limitations. The effect seen in the picture would be an overshoot or rounding of a fast transition between lower and higher brightness levels. In a composite NTSC or PAL television system, the color in the picture might be offset to the left or right of the associated luminance. The largest contributors to group-delay error are the NTSC/PAL encoder, the sound-notch filter, and the vestigial-side-

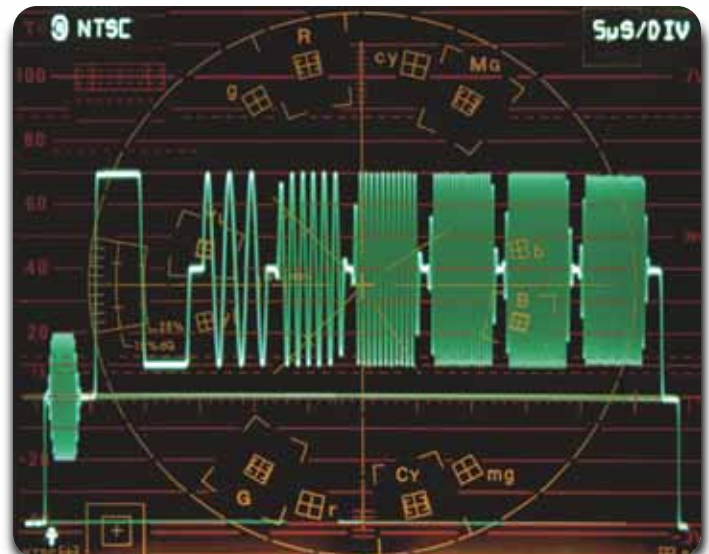

► **Figure 46.** Multiburst test signal with equal amplitude at each frequency, 1H display.

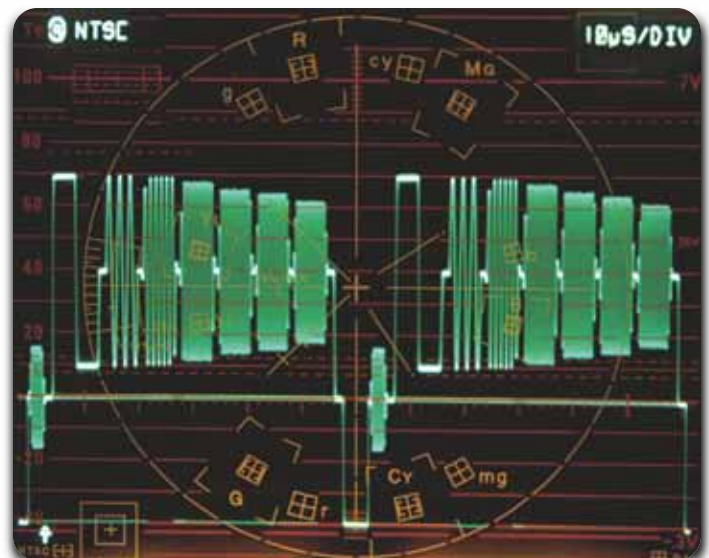

► **Figure 47.** Multiburst with frequency response rolloff, 2H display.

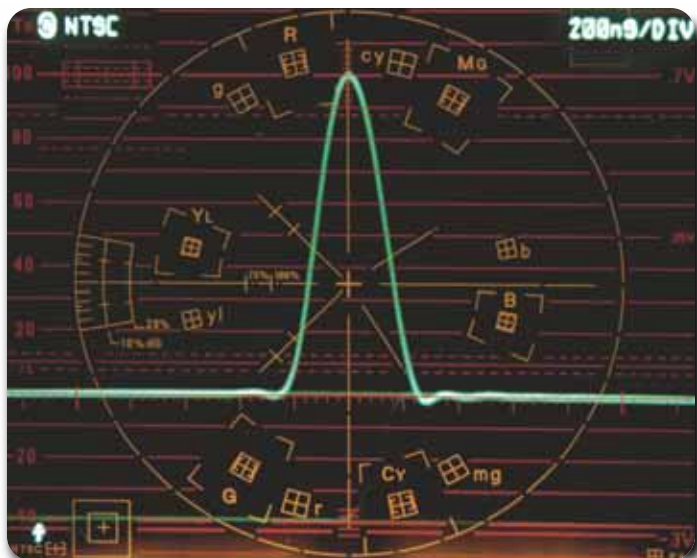

▶ **Figure 48.** Correct 2T pulse, 1H MAG display.

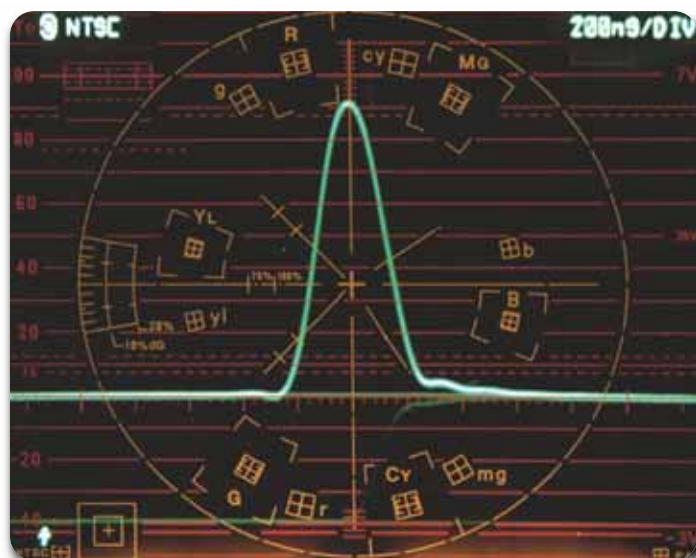

▶ **Figure 49.** 2T pulse and bar, degraded.

band filter in the high-power television station transmitter, and of course the complimentary chroma bandpass filters in the television receiver's NTSC or PAL decoder. From an operational standpoint, most of the effort to achieve a controlled group delay response centers in the analog transmitter plant. It is routine, however, to check group delay, or phase error, through the analog studio plant to identify gross errors that may indicate a failure in some individual device. Group delay error in a studio plant is easily checked with a pulse and bar test signal (Figure 48). This test signal includes a half-sinusoidal 2T pulse and a low-frequency white bar with fast, controlled rise and fall times. A 2T pulse with energy at half the system bandwidth causes a low level of ringing which should be symmetrical around the base of the pulse. If the high-frequency energy in the edge gets through faster or slower than the low-frequency energy, the edge will be distorted (Figure 49). If high-frequency energy is being delayed, the ringing will occur later, on the right side of the 2T pulse.

The composite pulse and bar test signal has a feature useful in the measurement of system phase response. In composite system testing, a 12.5T or 20T pulse modulated with energy at subcarrier frequency is used to quickly check both chroma-luma delay and relative gain at subcarrier frequency vs. a low frequency. A flat baseline indicates that both gain and delay are correct. Any bowing upward of the baseline through the system indicates a lower gain at the subcarrier frequency. Bowing downward indicates higher gain at the subcarrier frequency. Bowing upward at the begin-

ning and downward at the end indicates high-frequency energy has arrived later and vice versa. In a component video system, with no color subcarrier, the 2T pulse and the edge of the bar signal is of most interest.

A more comprehensive group delay measurement may be made using a multi-pulse or sin x/x pulse and is indicated when data, such as teletext or Sound-in-Sync is to be transmitted within the video signal.

Digital video system components use anti-alias and reconstruction filters in the encoding/decoding process to and from the analog domain. The cutoff frequencies of these internal filters are about 5.75 MHz and 2.75 MHz for standard definition component video channels, so they do react to video energy, but this energy is less than is present in the 1 MHz and 1.25 MHz filters in the NTSC or PAL encoder. Corresponding cutoff frequencies for filters in digital high-definition formats are about 30 MHz for luma and 15 MHz for chroma information. The anti-alias and reconstruction filters in digital equipment are well corrected and are not adjustable operationally.

### Non-linear effects

An analog circuit may be affected in a number of ways as the video operating voltage changes. Gain of the amplifier may be different at different operating levels (differential gain) causing incorrect color saturation in the NTSC or PAL video format. In a component analog format, brightness and color values may shift.



## Differential gain

Differential gain is an analog effect, and will not be caused or corrected in the digital domain. It is possible, however, that digital video will be clipped if the signal drives the analog-to-digital converter into the range of reserved values. This gamut violation will cause incorrect brightness of some components and color shift. Please refer to Appendix A – Gamut, Legal, Valid.

## Differential phase

Time delay through the circuit may change with the different video voltage values. This is an analog effect, not caused in the digital domain. In NTSC this will change the instantaneous phase (differential phase) of the color subcarrier resulting in a color hue shift with a change in brightness. In the PAL system, this hue shift is averaged out, shifting the hue first one way then the other from line to line. The effect in a component video signal, analog or digital, may produce a color fringing effect depending on how many of the three channels are affected. The equivalent effect in high definition may be a ring or overshoot on fast changes in brightness level.

## Timing between video sources

In order to transmit a smooth flow of information, both to the viewer and to the system hardware handling the signal, it is necessary that any mixed or sequentially switched video sources be in step at the point they come together. Relative timing between serial digital video signals that are within an operational range for use in studio equipment may vary from several nanoseconds to a few television lines. This relative timing can be measured by synchronizing a waveform monitor to an external source and comparing the relative positions of known picture elements.

Measurement of the timing differences in operational signal paths may be accomplished using the Active Picture Timing Test Signal available from the TG700 Digital Component Generator in conjunction with the timing cursors and line select of an externally referenced WFM601 or WFM700 Series serial component waveform monitor. The Active Picture Timing Test Signal will have a luminance white bar on the following lines:

- 525-line signals: Lines 21, 262, 284, and 525
- 625-line signals: Lines 24, 310, 336, and 622
- 1250, 1125, and 750 line formats: first and last active lines of each field

To set relative timing of signal sources such as cameras, telecines, or video recorders, it may be possible to observe the analog representation of the SAV timing reference signal, which changes amplitude as vertical

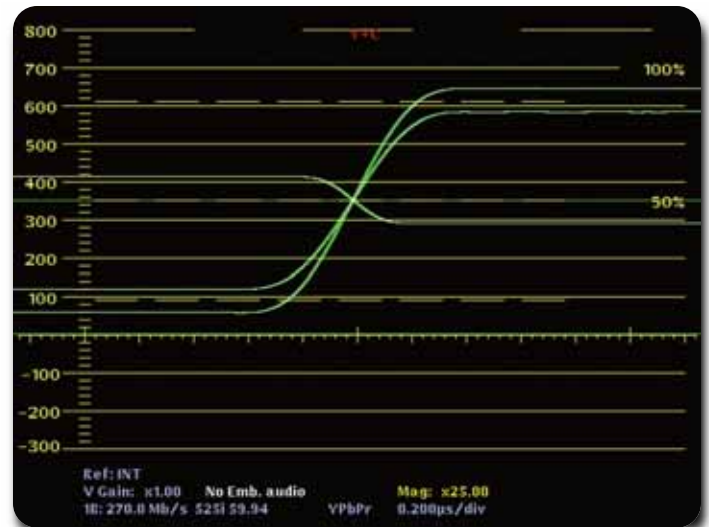

► **Figure 50.** Interchannel timing measurement using green/magenta transition.

blanking changes to active video. The waveform monitor must be set to “PASS” mode to display an analog representation of the timing reference signals, and be locked to an external synchronizing reference (EXT REF).

## Interchannel timing of component signals

Timing differences between the channels of a single component video feed will cause problems unless the errors are very small. Signals can be monitored in the digital domain, but any timing errors will likely be present from the original analog source. Since analog components travel through different cables, different amplifiers in a routing switcher, etc., timing errors can occur if the equipment is not carefully installed and adjusted. There are several methods for checking the interchannel timing of component signals. Transitions in the color bar test signal can be used with the waveform method described below. Tektronix component waveform monitors, however, provide two efficient and accurate alternatives: the Lightning display, using the standard color bar test signal; and the bowtie display, which requires a special test signal generated by Tektronix component signal generators.

## Waveform method

The waveform technique can be used with an accurately calibrated three-channel waveform monitor to verify whether transitions in all three channels are occurring at the same time. For example, a color bar signal has simultaneous transitions in all three channels at the boundary between the green and magenta bars (Figure 50).

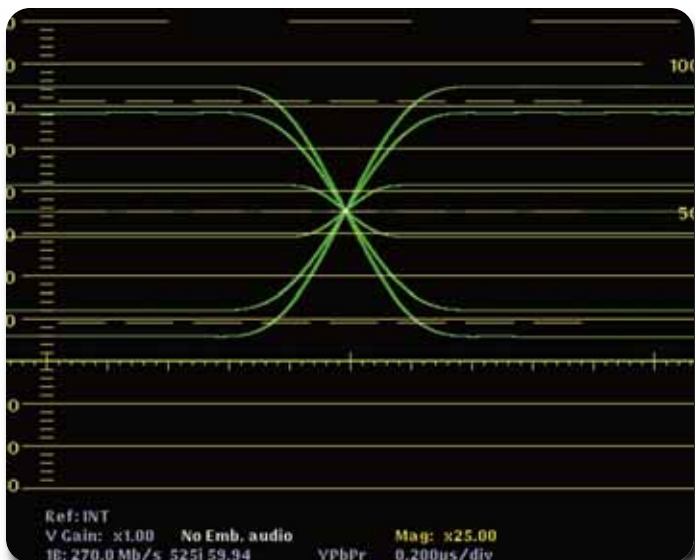

► **Figure 51.** TG700 reverse color bar signal, H MAG, OVERLAY.

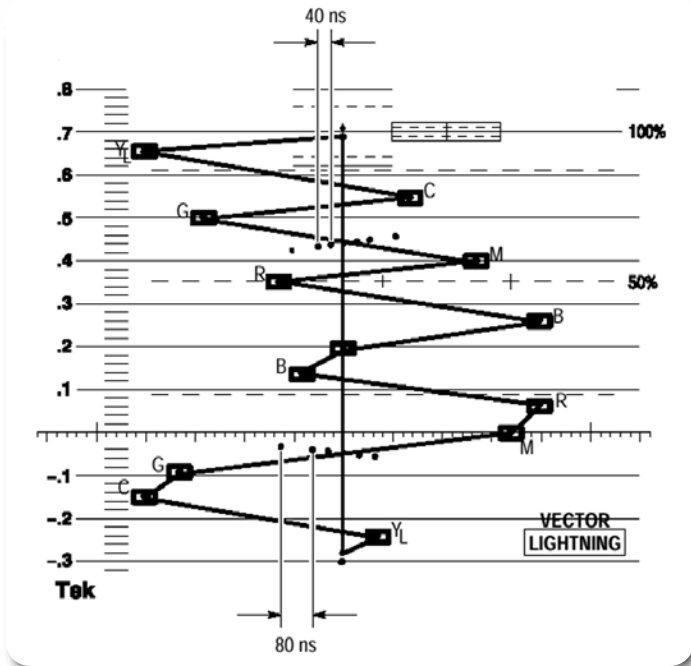

► **Figure 52.** Lightning display for a 100% color bar signal.

To use the waveform method to check whether the green-magenta transitions are properly timed:

1. Route the color bar signal through the system under test and connect it to the waveform monitor.
2. Set the waveform monitor to PARADE mode and 1 LINE sweep.
3. Vertically position the display, if necessary, so the midpoint of the Channel 1 green-magenta transition is on the 350 mV line.
4. Adjust the Channel 2 and Channel 3 position controls so the zero level of the color-difference channels is on the 350 mV line. (Because the color-difference signals range from -350 mV to +350 mV, their zero level is at vertical center.)
5. Select WAVEFORM OVERLAY mode and horizontal MAG.
6. Position the traces horizontally for viewing the proper set of transitions. All three traces should coincide on the 350 mV line.

The Tektronix TG700 and TG2000 test signal generators can be programmed to generate a special reverse bars test signal, with the color bar order reversed for half of each field. This signal makes it easy to see timing differences by simply lining up the crossover points of the three signals. The result is shown in Figure 51.

### Timing using the Tektronix Lightning display

The Tektronix Lightning display provides a quick, accurate check of inter-channel timing. Using a color bar test signal, the Lightning display includes graticule markings indicating any timing errors. Each of the Green/Magenta transitions should pass through the center dot in the series of seven graticule dots crossing its path. Figure 52 shows the correct timing.

The closely spaced dots provide a guide for checking transitions. These dots are 40 ns apart while the widely spaced dots represent 80 ns. The electronic graticule eliminates the effects of CRT nonlinearity. If the color-difference signal is not coincident with luma, the transitions between color dots will bend. The amount of this bending represents the relative signal delay between luma and color-difference signal. The upper half of the display measures the Pb to Y timing, while the bottom half measures the Pr to Y timing. If the transition bends in towards the vertical center of the black region, the color-difference signal is delayed with respect to luma. If the transition bends out toward white, the color difference signal is leading the luma signal.

## Bowtie method

The bowtie display requires a special test signal with signals of slightly differing frequencies on the chroma channels than on the luma channel. For standard definition formats, a 500 kHz sine-wave packet might be on the luma channel and a 502 kHz sine-wave packet on each of the two chroma channels (Figure 53). Other frequencies could be used varying the sensitivity of the measurement display.

Higher packet frequencies may be chosen for testing high-definition component systems. Markers generated on a few lines of the luma channel serve as an electronic graticule for measuring relative timing errors. The taller center marker indicates zero error, and the other markers are spaced at 20 ns intervals when the 500 kHz and 502 kHz packet frequencies are used. The three sine-wave packets are generated to be precisely in phase at their centers. Because of the frequency offset, the two chroma channels become increasingly out of phase with the luma channel on either side of center.

The waveform monitor subtracts one chroma channel from the luma channel for the left half of the bowtie display and the second chroma channel from the luma channel for the right half of the display. Each subtraction produces a null at the point where the two components are exactly in phase (ideally at the center). A relative timing error between one chroma channel and luma, for example, changes the relative phase between the two channels, moving the null off center on the side of the display for that channel. A shift of the null to the left of center indicates the color-difference channel is advanced relative to the luma channel. When the null is shifted to the right, the color-difference signal is delayed relative to the luma channel.

The null, regardless of where it is located, will be zero amplitude only if the amplitudes of the two sine-wave packets are equal. A relative amplitude error makes the null broader and shallower, making it difficult to accurately evaluate timing. If you need a good timing measurement, first adjust the

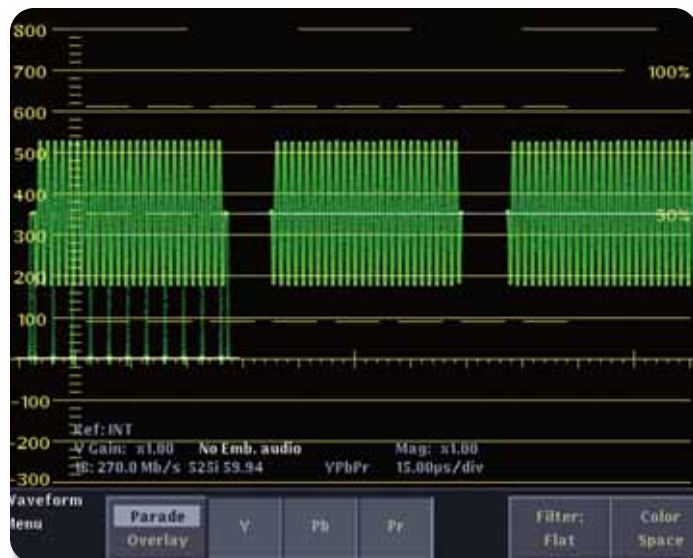

► **Figure 53.** Bowtie test signal.

amplitudes of the equipment under test. A gain error in the luma (CH1) channel will mean neither waveform has a complete null. If the gain is off only in Pb (CH2), the left waveform will not null completely, but the right waveform will. If the gain is off only in Pr (CH3) the right waveform will not null completely, but the left waveform will.

The bowtie test signal and display offers two benefits; it provides better timing resolution than the waveform and Lightning methods, and the display is readable at some distance from the waveform monitor screen.

Note that the bowtie test signal is an invalid signal, legal only in color-difference format. It becomes illegal when translated to RGB or composite formats and could create troublesome side effects in equipment that processes internally in RGB. (The concept of legal and valid signals is discussed in **Appendix A – Gamut, Legal, Valid**.)

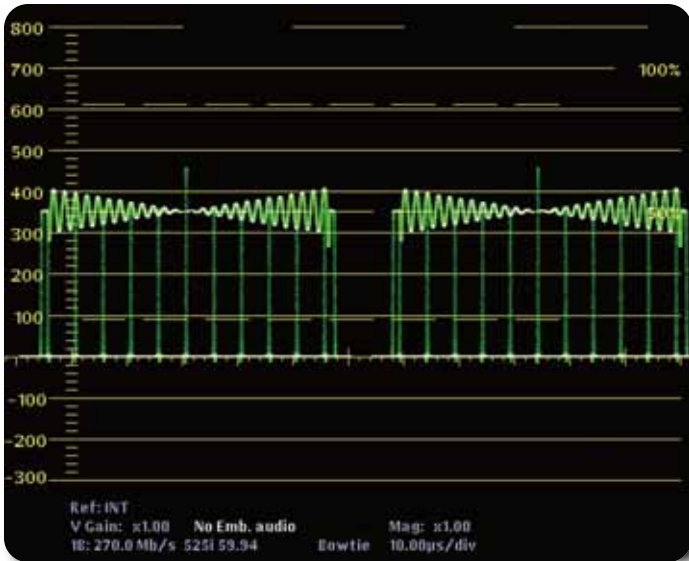

▶ **Figure 54.** Bowtie display, comparing Y & Pb (Right) and Y & Pr (Left).

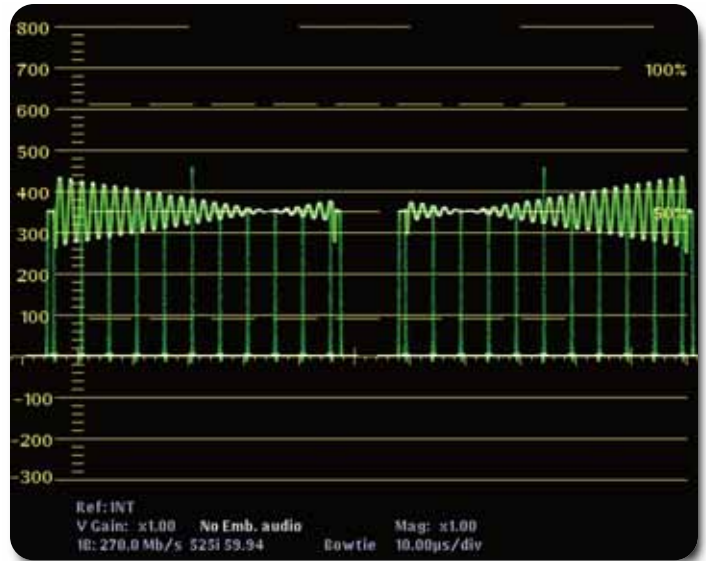

▶ **Figure 55.** Bowtie display, Pb advanced 55 ns, Pr delayed 50 ns vs. Y.

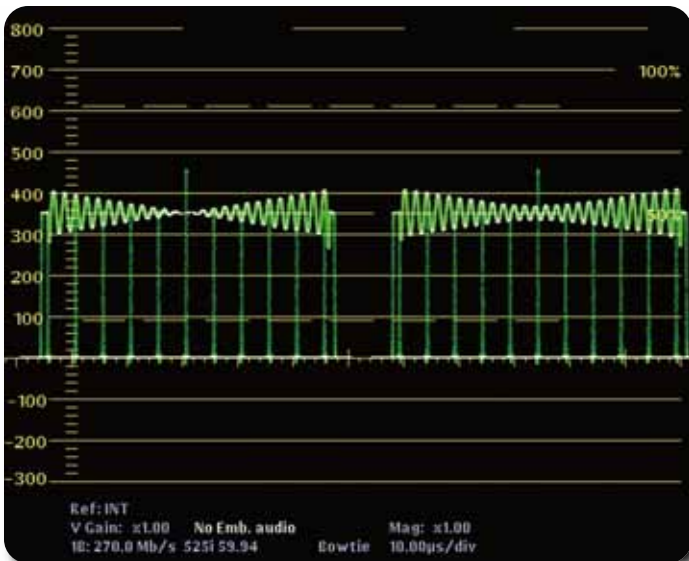

▶ **Figure 56.** Bowtie display, Pr gain error vs. Y.

The bowtie test method can be used to evaluate relative amplitudes and relative timing using component waveform monitors such as the Tektronix 1765, WFM601 Series, and WFM700 Series which have bowtie display modes.

The left side of the display (Figure 54) compares Y and Pb; the right side compares Y and Pr. The 5 ns advance of the Pr component vs. Y is generally acceptable.

To use the bowtie display, route the signal from the component generator through the equipment under test and connect it to the waveform monitor. Activate the BOWTIE display. If the bowtie patterns have a sharp null, and the null is at the center of each line, the relative amplitudes and interchannel timing are correct. Interchannel timing errors will move the position of the null (Figure 55). A relative amplitude error (Figure 56) will decrease the depth of the null. An incomplete null combined with an offset from center indicates both amplitude and timing problems between the channels being compared.



▶ Operating a Digital Television System



▶ **Figure 57.** WFM700 R'G'B' parade display of 100% color bars.



▶ **Figure 58.** WFM700 Y'C'b/C'r display of 100% color bars.

**RGB and color-difference waveforms**

Although the colorist will make equipment adjustments in the familiar red, green, blue format, the engineer may wish to see an analog representation of the signal matrixed for digital encoding. The digital signal is usually a direct quantization and time multiplex of the luma, or Y' signal, and the two chroma components, C'b and C'r. These three digital components can be converted to analog and directly displayed as a color-difference waveform parade, or matrixed back to red, green, and blue for the colorist. Examples of the two display formats are shown in Figure 57 and Figure 58.

**Component gain balance**

In a component signal, gain balance refers to the matching of levels between channels. If any of the components has an amplitude error relative to the others, it will affect the hue and/or saturation in the picture. Since in color-difference formats, different colors contain different signal amplitudes from the red, green, and blue channels, it is not always obvious how individual channel gains should be adjusted. Several displays have been developed to help the operator make these adjustments.

**The vector display**

The vector display (Figure 59) has long been used for monitoring chrominance amplitude in composite NTSC or PAL systems. When the demodula-



▶ **Figure 59.** NTSC vectorscope display.

tion phase is adjusted correctly, usually by the operator, to place the color synchronizing burst pointing left along the horizontal axis, the composite vector display is a Cartesian (x,y) graph of the two decoded color components. Demodulated R-Y on the vertical axis and B-Y on the horizontal axis.

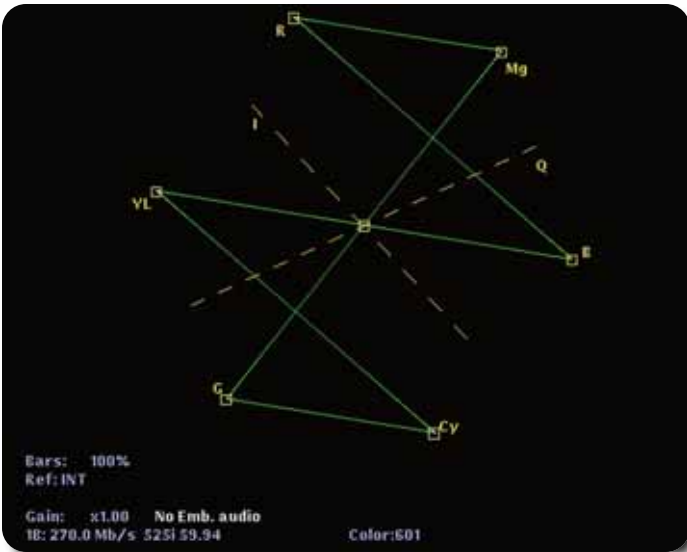

▶ **Figure 60.** Component vector display.

A similar display (Figure 60) for digital or analog component systems can be formed by plotting  $P'r$  or  $C'r$  on the vertical axis and  $P'b$  or  $C'b$  on the horizontal axis (Figure 61). Internal gains and display graticule box positions are adjusted in the monitoring instrument's design so the plot will fit the boxes for the chosen amplitude of color bars. If either color component has the wrong amplitude, the dots they produce will not fall in the graticule boxes. For example, if the  $P'r$  or  $C'r$  gain is too high, the dots will fall above the boxes in the top half of the screen and below the boxes in the bottom half. Either 75% or 100% color bars may be used. When taking measurements make certain the source signal amplitude matches the vector graticule.

The polar display permits measurement of hue in terms of the relative phase of the chroma signal. Amplitude of the chroma signal is the displacement from center towards the color point. The transitions from one point to another also provide useful timing information. These timing differences appear as looping or bowing of the transitions, but can more easily be measured using Lightning or bowtie methods.

The two-axis vector display is convenient for monitoring or adjusting the set of two color-difference components, but makes no provision for evaluating luma gain or for making chroma/luma gain comparisons. The vector display would look the same if the luma channel were completely missing.

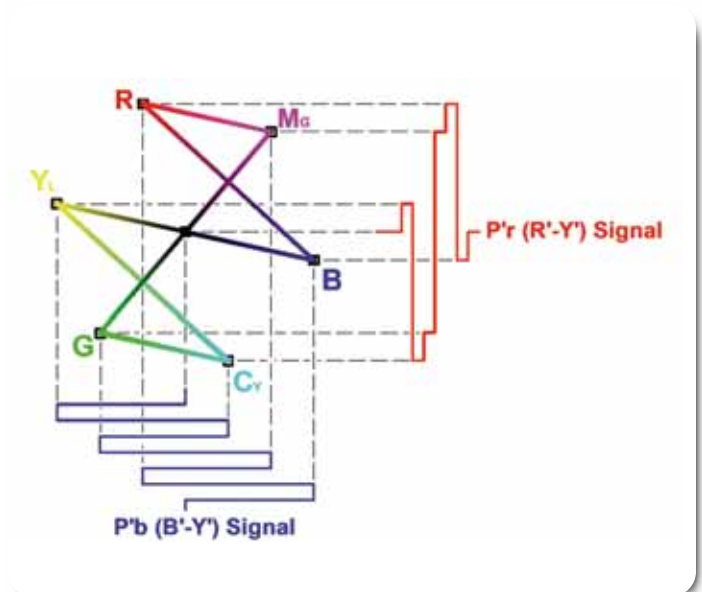

▶ **Figure 61.** Development of the component vector display.

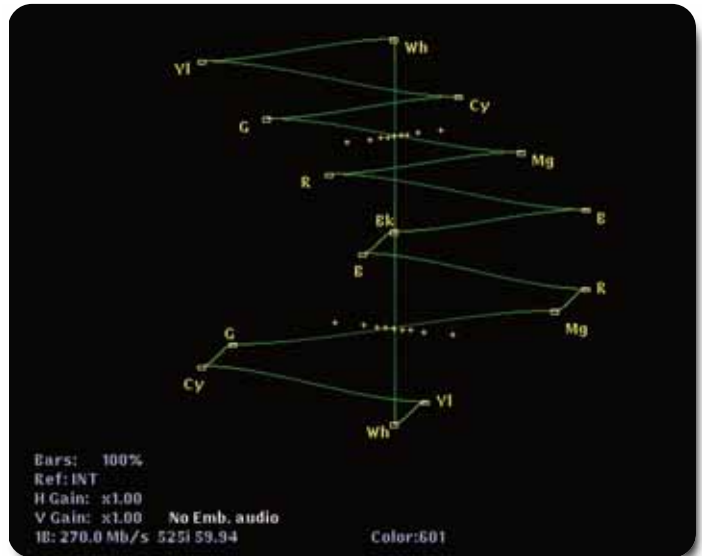

▶ **Figure 62.** The Tektronix Lightning display.

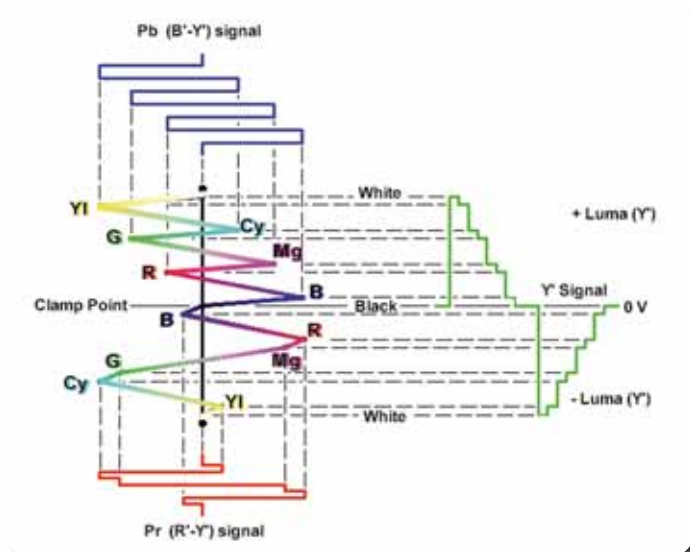

▶ **Figure 63.** Development of the Tektronix Lightning display.

### The Lightning display

Recognizing that a three-dimensional method would be desirable for monitoring the complete set of component signals, Tektronix developed a display (Figure 60) that provides both amplitude and interchannel timing information for the three signal channels on a single display. The only test signal required for definitive measurements is standard color bars.

The Lightning display is generated by plotting luma vs. P'b or C'b in the upper half of the screen and inverted luma vs. P'r or C'r in the lower half (Figure 63) – like two vector displays sharing the same screen. The bright

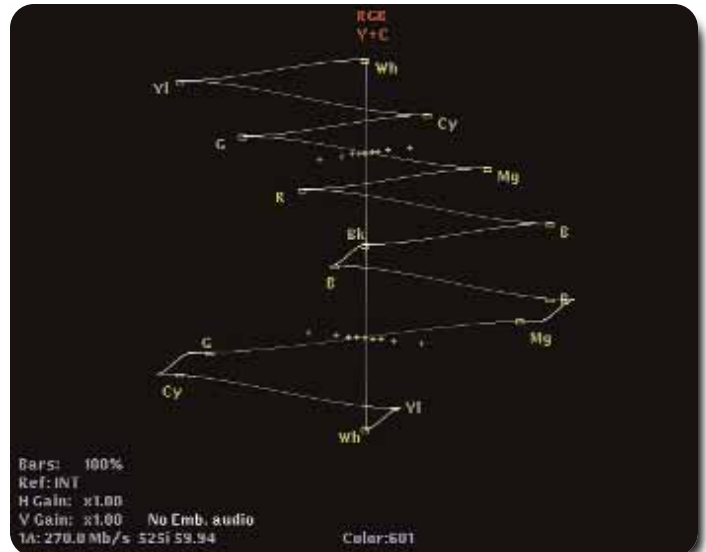

▶ **Figure 64.** Lightning display with P'r gain error.

dot at the center of the screen is blanking level (signal zero). Increasing luma is plotted upward to the upper half of the screen and downward in the lower half. If luma gain is too high, the plot will be stretched vertically. If P'r or C'r gain is too high (Figure 64), the bottom half of the plot will be stretched horizontally. If P'b or C'b is too high, the top half of the display will be stretched horizontally. The display also provides interchannel timing information by looking at the green/magenta transitions. When the green and magenta vector dots are in their boxes, the transition should intercept the center dot in the line of seven timing dots.





▶ **Figure 65.** Tektronix Diamond display of 75% color bars.

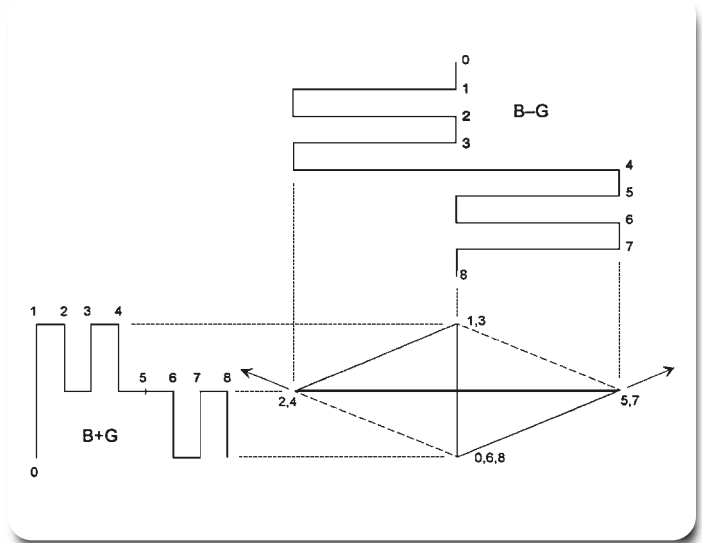

▶ **Figure 66.** Development of the Diamond display, upper half.

### The Diamond display

The Tektronix Diamond display (Figure 65) provides a reliable method of detecting invalid colors before they show up in a finished production. Color is usually developed and finally displayed in R'G'B' format. If it were handled through the system in this format, monitoring to detect an illegal signal would be quite simple – just insure that the limits are not exceeded. But most studio systems use a Y', C'b, C'r format for data transmission and processing, and the signal is often converted to PAL or NTSC for on-air transmission.

Ultimately all color video signals are coded as RGB for final display on a picture monitor.

The Tektronix Diamond display is generated by combining R', G', and B' signals. If the video signal is in another format, the components are converted to R', G', and B' which can be converted into a valid and legal signal in any format that can handle 100% color bars. (A notable exception is the NTSC transmission standard where regulatory agencies have set the white level too close to zero RF carrier to accommodate 100% color bars. (See Arrowhead display.)

The upper diamond (Figures 65 and 66) is formed from the transcoded signal by applying B'+G' to the vertical axis and B'-G' to the horizontal axis.

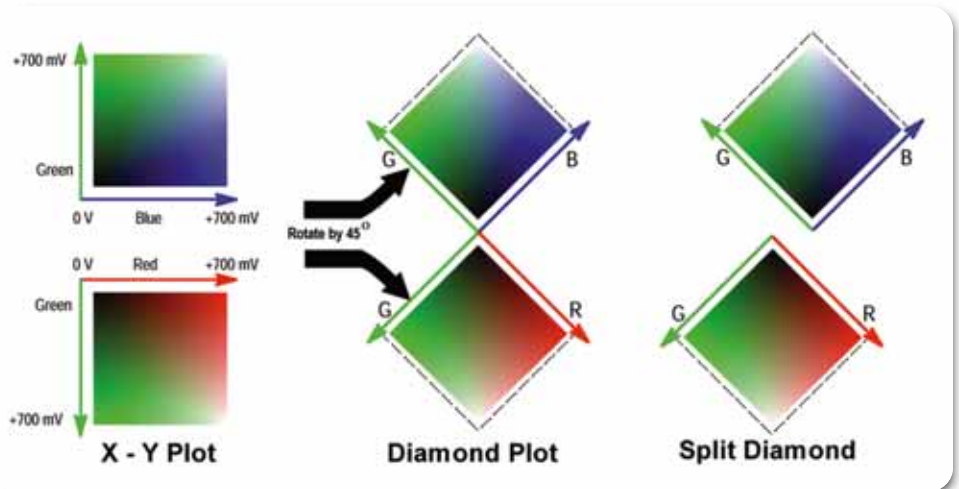

▶ **Figure 67.** Diamond display of legal color space.

The lower diamond is formed by applying  $-(R'+G')$  to the vertical axis and  $R'-G'$  to the horizontal axis. The two diamonds are displayed alternately to create the double diamond display. 1.5 MHz (standard definition, wider for high definition) low-pass filters are applied to each to eliminate the short-term out-of-limit signals that are usually the product of combining different bandwidth signals in color-difference formats.

To predictably display all three components, they must lie between peak white, 700 mV, and black 0 V (Figure 67). Picture monitors handle excursions outside the standard range (gamut) in different ways. For a signal to

be in gamut, all signal vectors must lie within the G-B and G-R diamonds. If a vector extends outside the diamond, it is out of gamut. Errors in green amplitude affect both diamonds equally, while blue errors only affect the top diamond and red errors affect only the bottom diamond. Timing errors can be seen using a color bar test signal as bending of the transitions. In the Diamond display, monochrome signals appear as vertical lines. However excursions below black can sometimes be masked in the opposite diamond. Therefore it can be useful to split the diamond into two parts to see excursions below black in either of the G-B or G-R spaces.

By observing the Diamond display, the operator can be certain the video components being monitored can be translated into legal and valid signals in RGB color space. The Diamond display can be used for live signals as well as test signals.

## The Arrowhead display

NTSC transmission standards will not accommodate 100% color bars, so you cannot be sure video that appears to be correct in the R', G', B' format can be faithfully transmitted through an amplitude-modulated NTSC transmitter. Traditionally, the signal had to be encoded into NTSC and monitored with an NTSC waveform monitor. The Tektronix Arrowhead display (Figures 68, 69, and 70) provides NTSC and PAL composite gamut information directly from the component signal.

The Arrowhead display plots luminance on the vertical axis, with blanking at the lower left corner of the arrow. The magnitude of the chroma subcarrier at every luminance level is plotted on the horizontal axis, with zero subcarrier at the left edge of the arrow. The upper sloping line forms a graticule

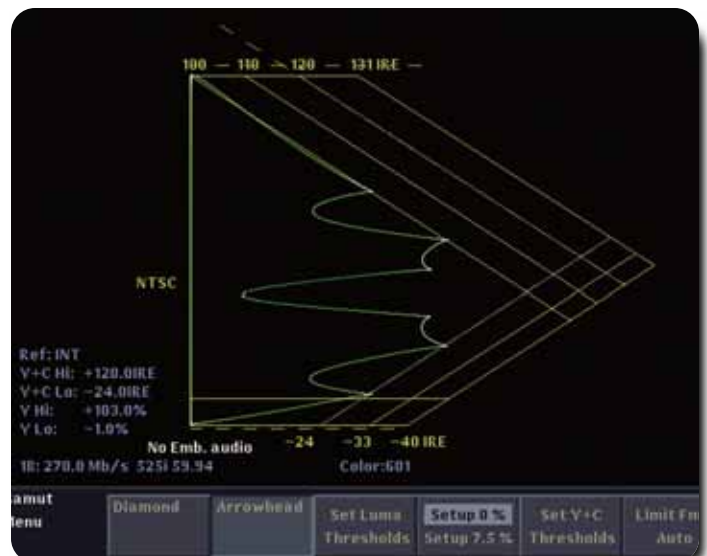
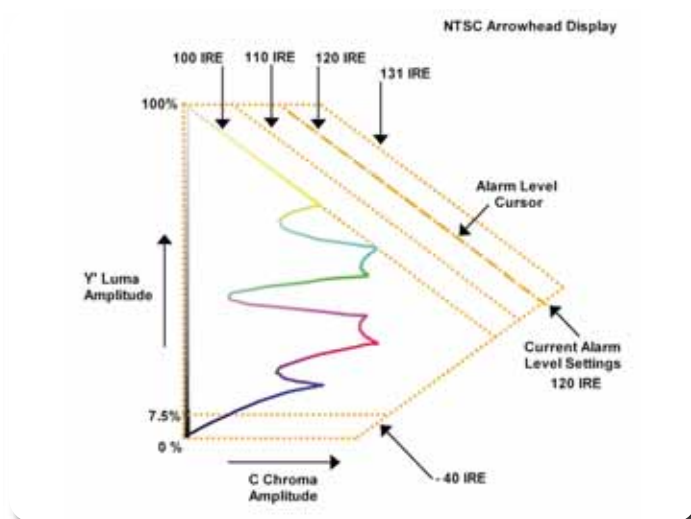
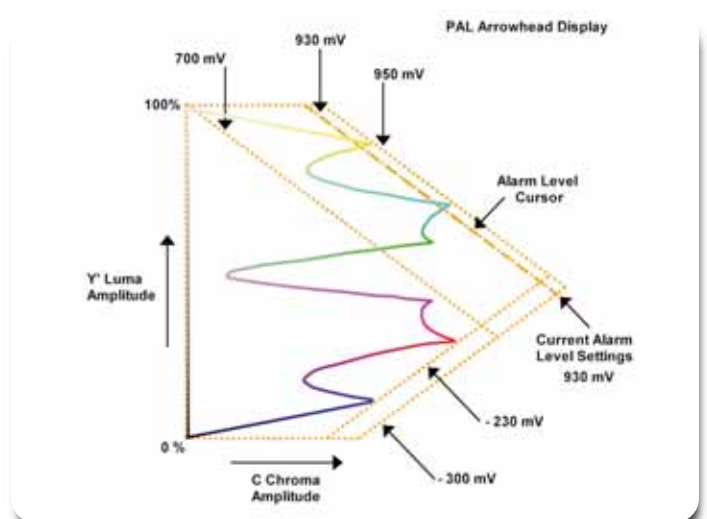

Figure 68. Tektronix Arrowhead display, 75% component color bars for NTSC.

indicating 100% color bar total luma + subcarrier amplitudes. The lower sloping graticule indicates a luma + subcarrier extending towards sync tip (maximum transmitter power). The electronic graticule provides a reliable reference to measure what luminance plus color subcarrier will be when the signal is later encoded into NTSC or PAL. An adjustable modulation depth alarm capability is provided to warn the operator that the composite signal may be approaching a limit. The video operator can now see how the component signal will be handled in a composite transmission system and make any needed corrections in production.



► Figure 69. NTSC Arrowhead graticule values.



► Figure 70. PAL Arrowhead graticule values.

## ▶ Digital System Testing

### Stress testing

Unlike analog systems that tend to degrade gracefully, digital systems tend to work without fault until they crash. To date, there are no in-service tests that will measure the headroom. Out-of-service stress tests are required to evaluate system operation. Stress testing consists of changing one or more parameters of the digital signal until failure occurs. The amount of change required to produce a failure is a measure of the headroom. Starting with the specifications in the relevant serial digital video standard (SMPTE 259M or SMPTE 292M), the most intuitive way to stress the system is to add cable until the onset of errors. Other tests would be to change amplitude or risetime, or add noise and/or jitter to the signal. Each of these tests are evaluating one or more aspects of the receiver performance, specifically automatic equalizer range and accuracy and receiver noise characteristics. Experimental results indicate that cable length testing, in particular when used in conjunction with the SDI check field signals described in the following sections, is the most meaningful stress test because it represents real operation. Stress testing the receiver's ability to handle amplitude changes and added jitter are useful in evaluating and accepting equipment, but not too meaningful in system operation. (Measuring the signal amplitude at the transmitter and measuring jitter at various points in the system is important in operational testing but not as stress testing.) Addition of noise or change in risetime (within reasonable bounds) has little effect on digital systems and is not important in stress tests.

### Cable length stress testing

Cable-length stress testing can be done using actual coax or a cable simulator. Coax is the simplest and most practical method. The key parameter to be measured is onset of errors because that defines the crash point. With an error measurement method in place, the quality of the measurement will be determined by the sharpness of the knee of the error curve. As an example, using 8281 coax in a 270 Mb/s system, a five-meter change in length will typically result in an increase in errors from no errors in one minute to more than one error-per-second.

Experiments have shown that good cable simulators require a 10- to 15-meter change in added 8281 coax to produce the same increase in errors.

An operational check of the in-plant cabling can be easily done using the WFM601M (Figure 71). This in-service check displays key information on the signal as it leaves the previous source and how it survives the transmission path.

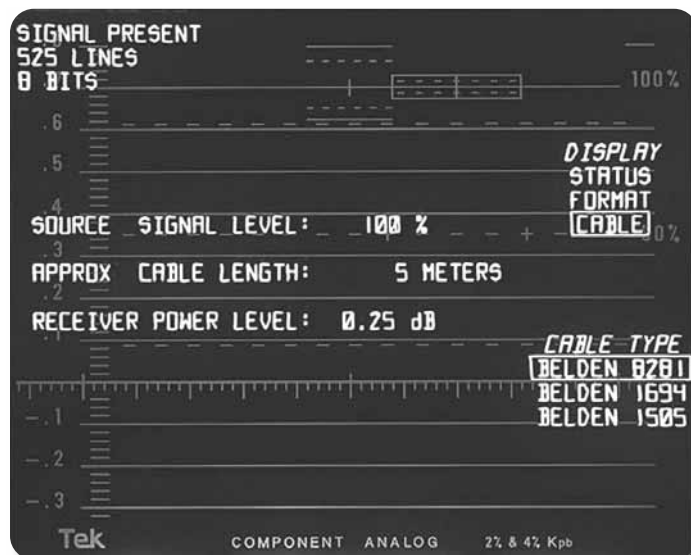

▶ **Figure 71.** Cable information screen, WFM601M.

### SDI check field

The SDI Check Field (also known as a “pathological signal”) is a full-field test signal and therefore must be done out-of-service. It’s a difficult signal for the serial digital system to handle and is a very important test to perform. The SDI Check Field is specified to have a maximum amount of low-frequency energy, after scrambling, in two separate parts of the field. Statistically, this low-frequency energy will occur about once per frame.

One component of the SDI Check Field tests equalizer operation by generating a sequence of 19 zeros followed by a 1 (or 19 ones followed by 1 zero). This occurs about once per field as the scrambler attains the required starting condition, and when it occurs it will persist for the full line and terminate with the EAV packet. This sequence produces a high DC component that stresses the analog capabilities of the equipment and transmission system handling the signal. This part of the test signal may appear at the top of the picture display as a shade of purple, with the value of luma set to  $198_{h}$ , and both chroma channels set to  $300_{h}$ .

The other part of the SDI Check Field signal is designed to check phase-locked loop performance with an occasional signal consisting of 20 zeros followed by 20 ones. This provides a minimum number of zero crossings for clock extraction. This part of the test signal may appear at the bottom of the picture display as a shade of gray, with luma set to  $110_{h}$  and both chroma channels set to  $200_{h}$ .

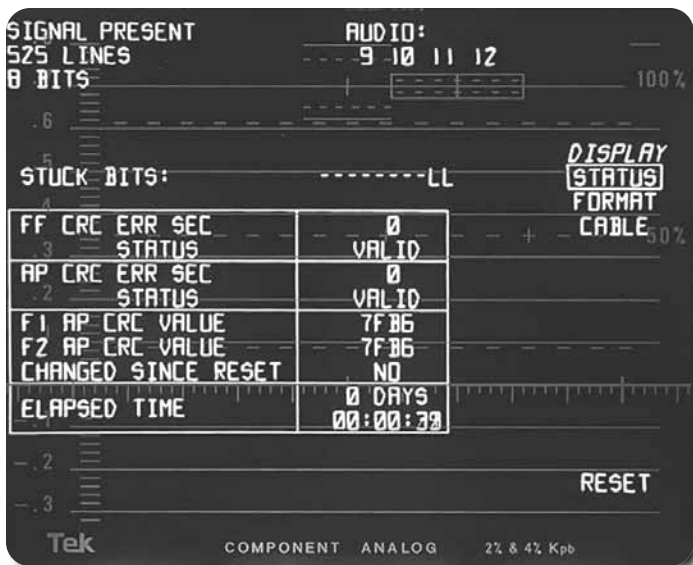

► **Figure 72.** Data information screen, WFM601M.

Some test signal generators will use a different signal order, with the picture display in shades of green. The results will be the same. Either of the signal components (and other statistically difficult colors) might be present in computer generated graphics so it is important that the system handle the SDI Check Field test signal without errors.

The SDI Check Field is a fully legal signal for component digital but not for the composite domain. The SDI Check Field is defined in SMPTE Recommended Practice RP178.

### CRC error testing

A Cyclic Redundancy Check (CRC) can be used to provide information to the operator or even sound an external alarm in the event data does not arrive intact. A CRC is present in each video line in high-definition formats, and may be optionally inserted into each field in standard definition formats. A CRC is calculated and inserted into the data signal for comparison with a newly calculated CRC at the receiving end. For standard definition formats, the CRC value is inserted into the vertical interval, after the switch point. SMPTE RP165 defines the optional method for the detection and handling of data errors in standard definition video formats. Full Field and

Active Picture data are separately checked and a 16-bit CRC word generated once per field. The Full Field check covers all data transmitted except in lines reserved for vertical interval switching (lines 9-11 in 525, or lines 5-7 in 625 line standards). The Active Picture check covers only the active video data words, between but not including SAV and EAV. Half-lines of active video are not included in the Active Picture check. Digital monitors may provide both a display of CRC values and an alarm on any CRC errors (Figure 72).

In high-definition formats, CRCs for luma and chroma follow EAV and line count ancillary data words. The CRC for 1125 line high-definition formats is defined in SMPTE 292M to follow the EAV and line number words, so CRC checking is on a line-by-line basis.

### Jitter testing

Since there is no separate clock provided with the video data, a sampling clock must be recovered by detecting data transitions. This is accomplished by directly recovering energy around the expected clock frequency to drive a high-bandwidth oscillator (i.e., a 5 MHz bandwidth 270 MHz oscillator) locked in near-real-time with the incoming signal. This oscillator then drives a heavily averaged, low-bandwidth oscillator (i.e., a 10 Hz bandwidth 270 MHz oscillator). In a jitter measurement instrument, samples of the high- and low-bandwidth oscillators are then compared in a phase demodulator to produce an output waveform representing jitter. This is referred to as the "demodulator method".

Timing jitter is defined as the variation in time of the significant instances (such as zero crossings) of a digital signal relative to a jitter-free clock above some low frequency (typically 10 Hz). It would be preferable to use the original reference clock, but it is not usually available, so a new heavily-averaged oscillator in the measurement instrument is often used.

Alignment jitter, or relative jitter, is defined as the variation in time of the significant instants (such as zero crossings) of a digital signal relative to a hypothetical clock recovered from the signal itself. This recovered clock will track in the signal up to its upper clock recovery bandwidth, typically 1 KHz to 100 KHz. Measured alignment jitter includes those terms above this frequency. Alignment jitter shows signal-to-latch clock timing margin degradation.



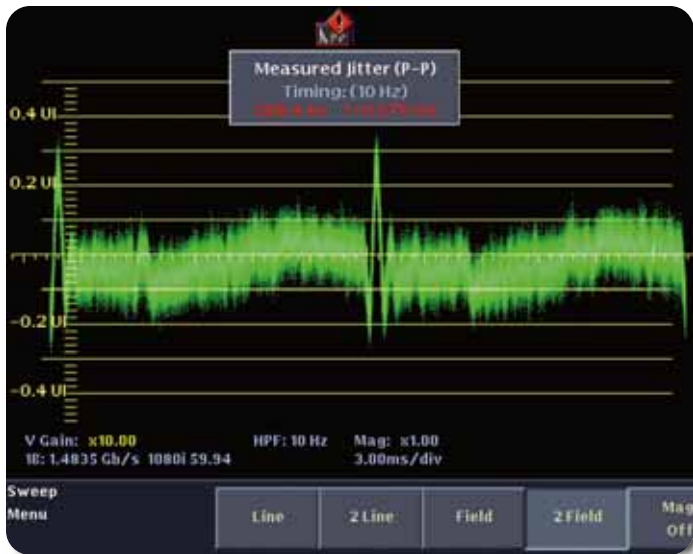

► **Figure 73.** Demodulated jitter display, two field rate, WFM700M.

Tektronix instruments such as the WFM601M (Figure 73), WFM700M and VM700T provide a selection of high-pass filters to isolate jitter energy. Jitter information may be unfiltered (the full 10 Hz to 5 MHz bandwidth) to display Timing Jitter, or filtered by a 1 kHz (–3 dB) high-pass filter to display 1 kHz to 5 MHz Alignment Jitter. Additional high-pass filters may be selected to further isolate jitter components. These measurement instruments provide a direct readout of jitter amplitude and a visual display of the demodulated jitter waveform to aid in isolating the cause of the jitter.

It is quite common for a data receiver in a single path to tolerate jitter considerably in excess of that specified by SMPTE recommendations but the buildup of jitter (jitter growth) through multiple devices could lead to unexpected failure. Jitter in bit-serial systems is discussed in SMPTE RP184, EG33, and RP192.

### Eye pattern testing

The eye pattern (Figures 74 and 75) is an oscilloscope view of the analog signal transporting the data. The signal highs and lows must be reliably detectable by the receiver to yield real-time data without errors. The basic parameters measured with the eye-pattern display are signal amplitude, risetime, and overshoot. Jitter can also be measured with the eye pattern if the clock is carefully specified. The eye pattern is viewed as it arrives, before any equalization. Because of this, most eye-pattern measurements will be made near the source, where the signal is not dominated by noise and frequency rolloff.

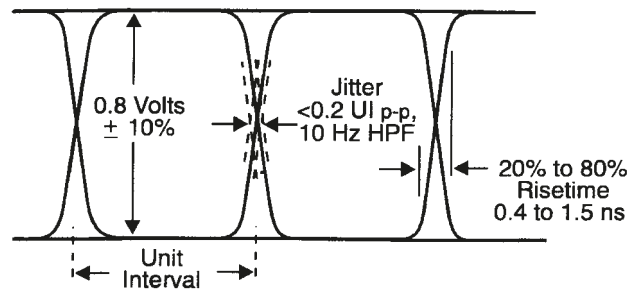

► **Figure 74.** Eye-pattern display of data signal in the analog transport layer.

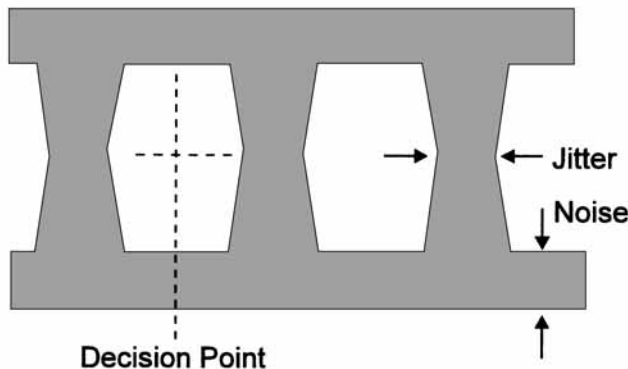

► **Figure 75.** Data recovery of serial signal.

Important specifications include amplitude, risetime, and jitter, which are defined in the standards, SMPTE259M, SMPTE292, and RP184. Frequency, or period, is determined by the television sync generator developing the source signal, not the serialization process.

A unit interval (UI) is defined as the time between two adjacent signal transitions, which is the reciprocal of clock frequency. The unit interval is 3.7 ns for digital component 525 and 625 (SMPTE 259M) and 673.4 ps for Digital High Definition (SMPTE 292M). A serial receiver determines if the signal is a “high” or a “low” in the center of each eye, thereby detecting the serial data. As noise and jitter in the signal increase through the transmission channel, certainly the best decision point is in the center of the eye (as shown in Figure 75) although some receivers select a point at a fixed time after each transition point. Any effect which closes the eye may reduce the usefulness of the received signal. In a communications system

# A Guide to Standard and High-Definition Digital Video Measurements

## ► Primer

with forward error correction, accurate data recovery can be made with the eye nearly closed. With the very low error rates required for correct transmission of serial digital video, a rather large and clean eye opening is required after receiver equalization. This is because the random nature of the processes that close the eye have statistical "tails" that would cause an occasional, but unacceptable error. Allowed jitter is specified as 0.2 UI this is 740 ps for digital component 525 and 625 and 134.7 ps for digital high definition. Digital systems will work beyond this jitter specification, but will fail at some point. The basics of a digital system is to maintain these specifications to keep the system healthy and prevent a failure which would cause the system to fall off the edge of the cliff.

Signal amplitude is important because of its relation to noise, and because the receiver estimates the required high-frequency compensation (equalization) based on the half-clock-frequency energy remaining as the signal arrives. Incorrect amplitude at the sending end could result in an incorrect equalization being applied at the receiving end, causing signal distortions.

Rise-time measurements are made from the 20% to 80% points as appropriate for ECL logic devices. Incorrect rise time could cause signal distortions such as ringing and overshoot, or if too slow, could reduce the time available for sampling within the eye.

Overshoot could be the result of incorrect rise time, but will more likely be caused by impedance discontinuities or poor return loss at the receiving or sending terminations. Effective testing for correct receiving end termination requires a high-performance loop-through on the test instrument to see any defects caused by the termination under evaluation. Cable loss tends to reduce the visibility of reflections, especially at high-definition data rates of 1.485 Gb/s and above. High-definition digital inputs are usually terminated internally and in-service eye-pattern monitoring will not test the transmission path (cable) feeding other devices. Out-of-service transmission path testing is done by substituting a test signal generator for the source, and a waveform monitor with eye pattern display in place of the normal receiving device.

Eye pattern testing requires an oscilloscope with a known response well beyond the transport layer data rate and is generally measured with sampling techniques. The Tektronix VM700T, WFM601E, WFM601M, and WFM700M provide eye-pattern measurement capability for standard definition (270 Mb/s data) and the WFM700M allows eye pattern measurements on high-definition 1.485 Gb/s data streams. These digital waveform monitors provide several advantages because they are able to extract and display the video data as well as measure it. The sampled eye pattern can be displayed in a three data bit overlay to show jitter uncorrelated to the 10-bit data word, or the display can be set to show ten bits of word-correlated data. And by synchronizing the waveform monitor sweep to video, it is easy to see any DC shift in the data stream correlated to horizontal or vertical video information.

## Conclusion

It has been the goal of this primer to provide background information on the transition of the television studio from analog to digital and high-definition video formats.

Today's video professional faces many challenges and the transition to digital should be one of those providing a great long-term return. The typical broadcaster and production studio will operate in both standard and high-definition video formats. The new digital formats, natural extensions of familiar analog video, offer a superior channel for the video professional's creativity, a higher level of performance and reliability for the engineer, and a new, exciting viewing experience for the consumer that will continue the industry's growth and success.

There will be many changes in your future. The authors hope you find the transition from analog to digital video among the most rewarding.

▶ Appendix A – Color and Colorimetry

The television color specification is based on standards defined by the CIE (Commission Internationale de L'Éclairage) in 1931. This system is based on experiments with a group of observers matching a color to an additive mix of three primaries – red, green and blue. The average of this experiment results in a graph that shows the color matching function (Figure A1) of a standard (average) observer. RGB tristimulus values are restricted by gamut restraint and cannot produce all colors. In order to produce the full range of colors, negative values of RGB would be required. This is an inappropriate model for television colorimetry. The CIE specified an idealized set of primary XYZ tristimulus values. These values are a set of all-positive values converted from the RGB tristimulus values where the value Y is proportional to the luminance of the additive mix. This specification is used as the basis for color within today's video standards.

The CIE standardized a procedure for normalizing XYZ tristimulus values to obtain a two-dimensional plot of values x and y of all colors for a relative value of luminance as specified by the following equations. A color is plotted as a point in an (x, y) chromaticity diagram, illustrated in Figure A2.

$$x = X / (X + Y + Z)$$

$$y = Y / (X + Y + Z)$$

$$z = Z / (X + Y + Z)$$

$$1 = x + y + z$$

Limits are defined for various video formats that show all possible colors for that format. Color-coded triangles (SMPTE = yellow, EBU/PAL/SECAM = blue, NTSC 1953 = green) in Figure A3 are specified by x, y coordinates in Table A1.

The x, y coordinates chosen are dependent on the phosphors used in manufacture of the CRT. NTSC phosphors specified in 1953 have been superseded by those of EBU and SMPTE because of the requirement for brighter displays.

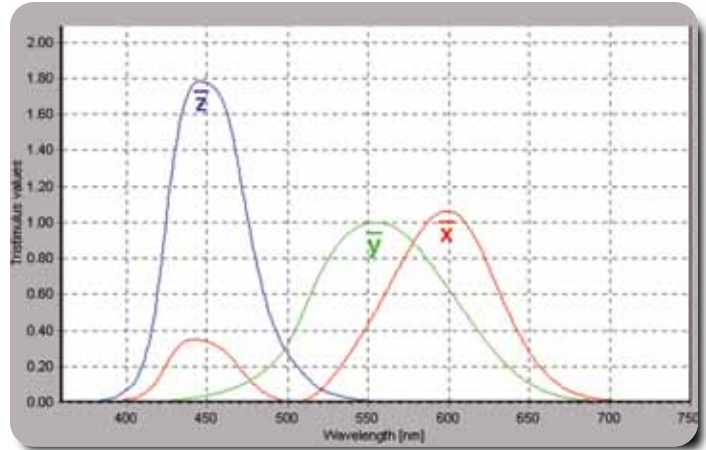

▶ Figure A1. CIE 1931 Color matching function (2 degree observer).

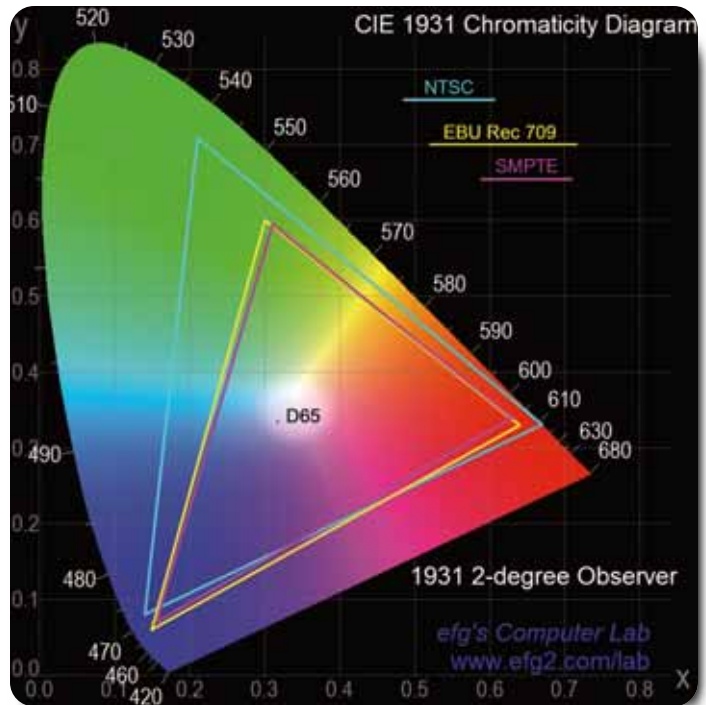

▶ Figure A2. CIE x y Chromaticity with coordinate values for SMPTE, EBU/PAL/SECAM, and NTSC 1953.



## White

An important consideration in the definition of colors is the white point of the system and therefore within each format a white point is defined which is the addition of red, green, and blue in equal quantities.

The CIE defined several standard sources in 1931:

- ▶ Source A: A tungsten-filament lamp with a color temperature of 2854K
- ▶ Source B: A model of noon sunlight with a color temperature of 4800K
- ▶ Source C: A model of average daylight with a color temperature of 6504K

Illuminant C (Source C) was used in the original definition of NTSC. The CIE later defined a series of daylight illuminants called the Daylight D series. Illuminant D65 with a color temperature of 6504K, and slightly different x, y coordinates is predominately used with video standards today.

Each of the sources has a white point and is given a x, y value on the chromaticity diagram.

Illuminant A	x = 0.4476	y = 0.4075
Illuminant B	x = 0.3484	y = 0.3516
Illuminant C	x = 0.3101	y = 0.3162
Illuminant D65	x = 0.3127	y = 0.3290

Current standards assume the television studio is illuminated by a source with Illuminant D65. In practice, studio lighting may not be Illuminant D65 and adjusting the gain of the red, green, blue components will compensate the white balance of the camera.

Table A1. CIE x, y Coordinate Values for Various Formats

SMPTE	RED		GREEN		BLUE	
	Xr	Yr	Xg	Yg	Xb	Yb
	0.630	0.340	0.310	0.595	0.155	0.070
Illuminant D65	x = 0.3127		y = 0.3290			

EBU	RED		GREEN		BLUE	
	Xr	Yr	Xg	Yg	Xb	Yb
Rec 709	0.640	0.330	0.300	0.600	0.150	0.060
Illuminant D65	x = 0.3127		y = 0.3290			

PAL/SECAM	RED		GREEN		BLUE	
	Xr	Yr	Xg	Yg	Xb	Yb
	0.64	0.330	0.290	0.60	0.150	0.060
Illuminant D65	x = 0.3127		y = 0.3290			

NTSC (1953)	RED		GREEN		BLUE	
	Xr	Yr	Xg	Yg	Xb	Yb
	0.670	0.330	0.210	0.710	0.140	0.080
Illuminant C	x = 0.3101		y = 0.3162			

## Red, green, and blue components

Components in some form are a necessary part of any color television system. Color cameras usually analyze the light in the image to develop video signals for three primary colors: red, green, and blue. Since each of these gamma corrected R'G'B' signals carries part of the information in the image, and all are required to recreate a complete image, they are referred to as "components" of the color video signal. As in the more generic use of the term, each component is a necessary, but not sufficient, part of the whole. The basic R'G'B' component signals are used again at the output of a television system to display the image on a monitor or TV set. Therefore, it makes sense to say that one of the primary tasks of a television plant is

to convey these component signals through all the distribution, technical, and artistic processes and deliver them to a display for viewing. Although some equipment, especially in the past, distributed RGB signals beyond the camera (or camera control unit), video has almost always been translated or encoded into other formats for recording, interconnection, or long distance transmission, then decoded for display.

Another means of representing Red, Green, and Blue primary colors is by a three-dimensional R'G'B' color cube representation. All colors can be represented within the bounds of the RGB color cube as shown in Figure A3.

The color television system was developed to be compatible with existing black and white television receivers. The gamma corrected luma signal, Y', is created from the red, green, and blue camera signals, for transmission to black and white or color receivers as a monochrome picture. By knowing the difference between the monochrome or luma channel and any two color channels, we can recover red, green, and blue to drive the color picture tube. Since human vision green

response most closely tracks brightness, a majority of that color information is used to make up the luma signal, and the remaining red and blue color-difference channels can be transmitted at a lower bandwidth.

The luma signal and the two color-difference signals contain all the information needed to display any of the broad range of colors possible in the original image. The basic set of three components (R', G', and B') is thus translated to a new set of three components (Y', R'-Y', B'-Y') by a simple matrix as shown in Figure A4. The color-difference component form has two advantages over R'G'B'. First, substantially less bandwidth is required to convey necessary information: a color-difference system needs only one high-bandwidth channel because all the fine detail in the image is carried by the luma signal. An R'G'B' system, on the other hand, requires high bandwidth in all three channels. Second, gain distortions have less severe effects on a

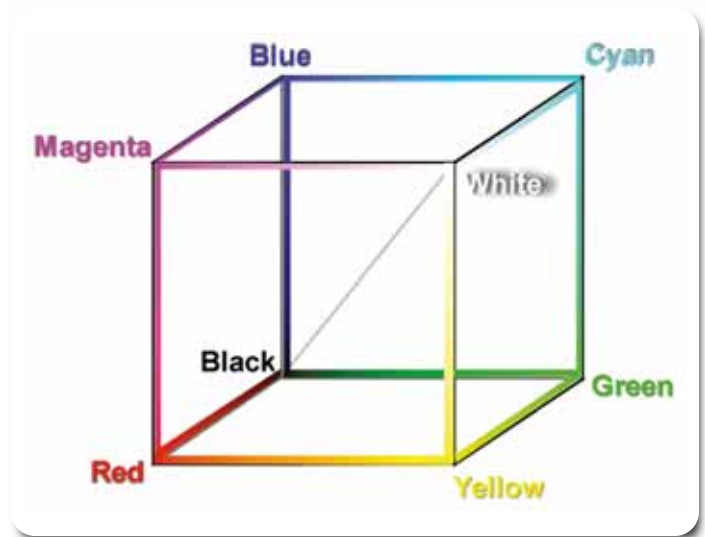

▶ **Figure A3.** R'G'B' color cube.

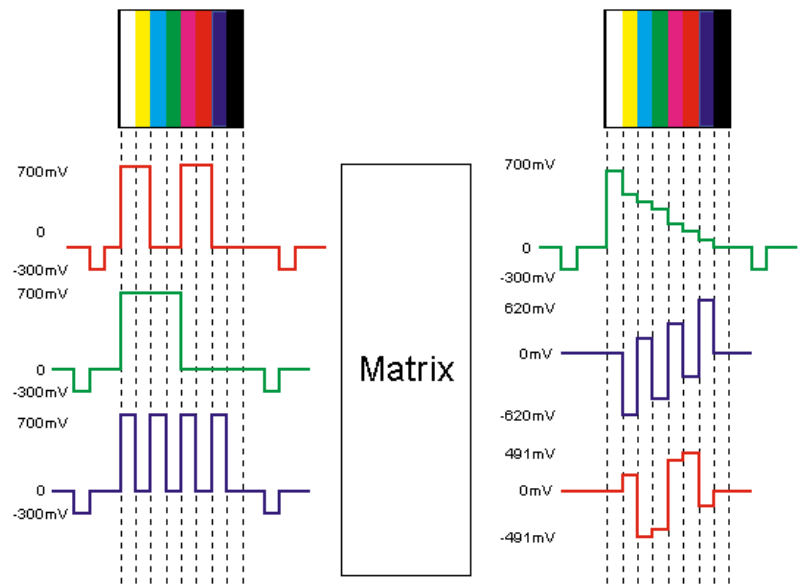

▶ **Figure A4.** Matrix of R'G'B' signal-to-color difference.

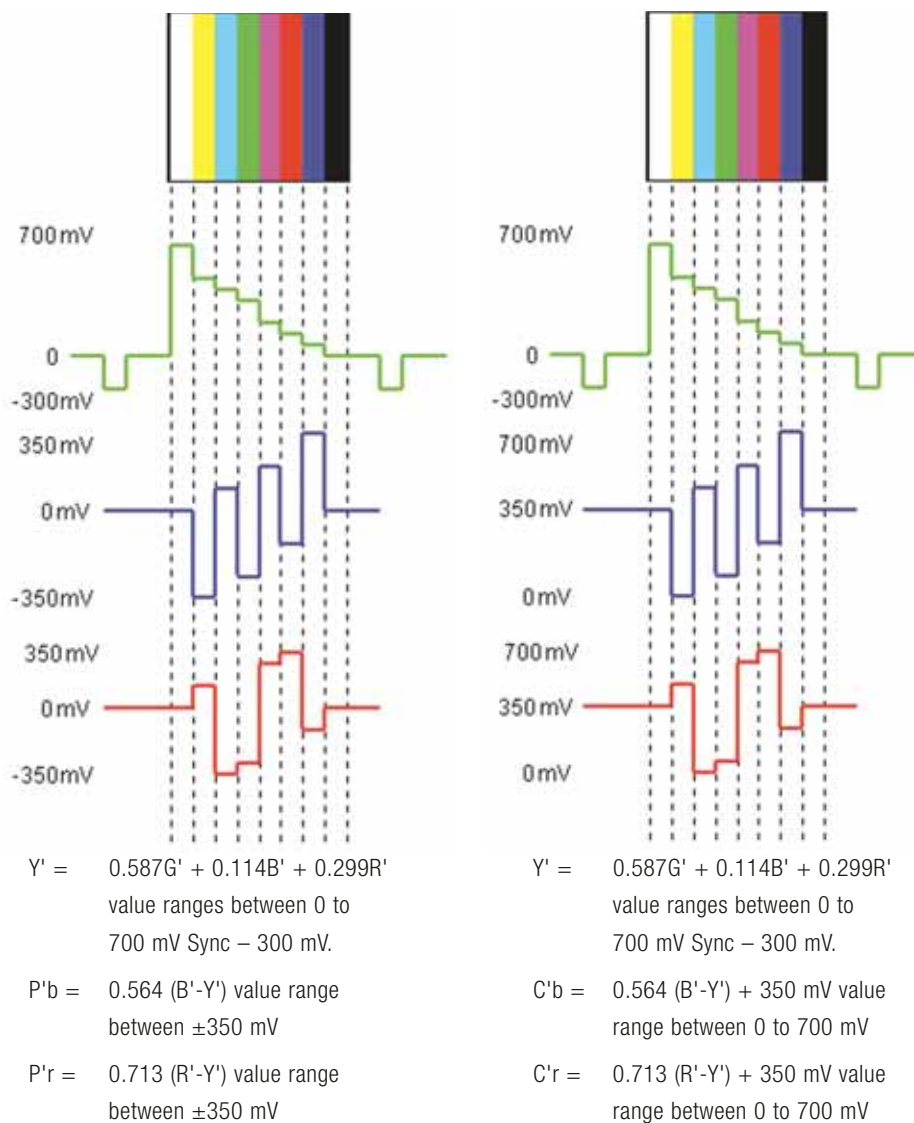

▶ **Figure A5.** color-difference signals scaled and offset for digital quantizing.

color-difference component set than on R'G'B'. A low level on any one channel in a color-difference set will produce subtle changes in hue or changes in saturation only. A low level in R'G'B', however, will produce a distinctly wrong-colored image. The concept of transcoding R'G'B' to one luma and two color-difference signals has proven very useful. Such signals, with relatively minor variations, are the basis for all existing component video formats and also for composite broadcast standards throughout the world.

For standard definition (Figure A5):

- ▶  $Y' = 0.587G' + 0.114B' + 0.299R'$  value ranges between 0 to 700 mV Sync - 300 mV
- ▶  $B' - Y' = -0.587G' + 0.866B' - 0.299R'$  value ranges between  $\pm 620$  mV
- ▶  $R' - Y' = -0.857G' - 0.114B' + 0.701R'$  value ranges between  $\pm 491$  mV

In the component video domain, component R'G'B' signals are often referred to as G'B'R' because the majority of the luminance signal is made up of green channel information. Therefore there is a correspondence between Y'P'bP'r and G'B'R'.

Color-difference values (Figure A5) are first scaled to produce an equal dynamic range of  $\pm 350$  mV for ease of processing within various systems. The analog component signal is denoted Y'P'bP'r and the digital component system, which introduces an offset to the color-difference signals to allow similar pro-

cessing ranges for the Y and color-difference signals values, is denoted  $Y'C'bC'r$ .

Performing this matrixing and scaling prevents all possible values of  $Y'C'bC'r$  signals being used when the signal is converted back to RGB. As illustrated in Figure A6, only about 25% of all possible signal values in the  $Y'C'bC'r$  domain are used to present the entire gamut of colors in the RGB domain. Because of this, care must be taken when translating between formats that the dynamic range is not exceeded in the conversion process.

### Gamut, legal, valid

The term gamut has been used to refer to the range or gamut of reproducible colors by a television system when the scene is illuminated by a reference white (illuminant  $D_{65}$  for NTSC/PAL). This gamut is defined by the chromaticity value or CIE chromaticity coordinates for a given system. This range of colors of variable saturation is reproduced in the picture monitor by red, green, and blue or  $R'G'B'$  signal values. When equal valued, (i.e.,  $R' = G' = B'$ ) the image is colorless to the extent it represents shades of gray on a properly-adjusted picture monitor. Otherwise, a colored hue of nonzero saturation results and all colors in the gamut of reproducible colors are possible by independently adjusting the values of the  $R'G'B'$  signals.

Since the values of the  $R'G'B'$  signals directly represent these colors, the term gamut is often used to refer to the range of colors represented by all combinations of  $R'G'B'$  signals that lie within the legal limits of 0 and 700 mV.  $R'G'B'$  signals extending outside this voltage range may produce desirable color on a given picture monitor, but are outside the valid color gamut. They may be clipped or compressed in subsequent signal processing, distorting the color when displayed on another picture monitor.

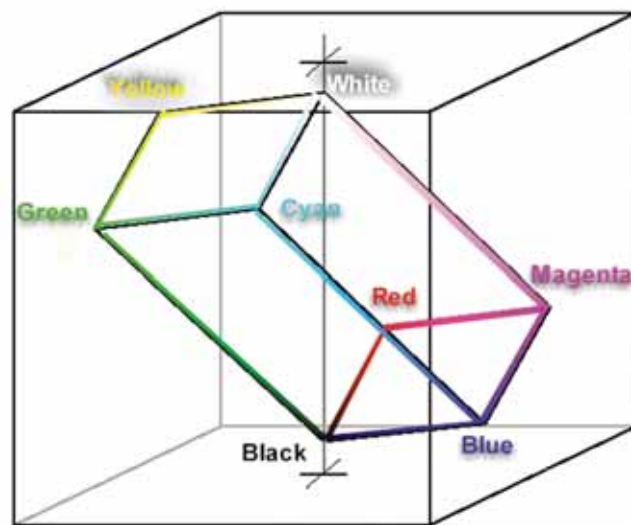

▶ **Figure A6.**  $Y'C'bC'r$  3D color space.

So in the  $R'G'B'$  domain, any channel exceeding either the upper or lower limit represents an invalid signal, since the color falls outside the valid color gamut. It is also illegal since one or more of the components exceeds the legal limits.

Legal signals are simply those signals that do not violate the signal-voltage limits for the particular format in use, i.e., signals within the allowed signal limits for that format. So a legal signal in a color-difference format like  $Y'C'bC'r$  can be invalid in that it can represent a color outside the valid color gamut. Such an invalid signal will always produce an illegal signal when transcoded to  $R'G'B'$ .

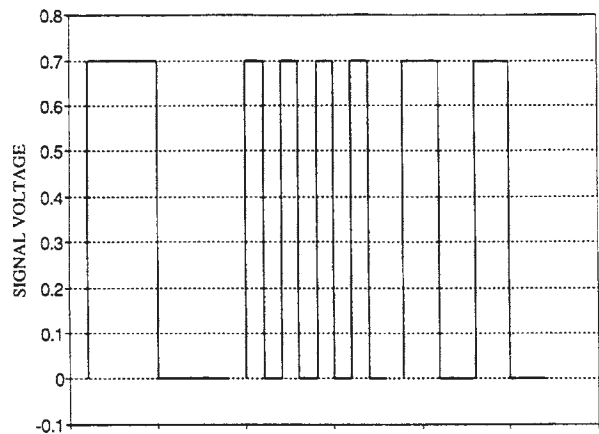
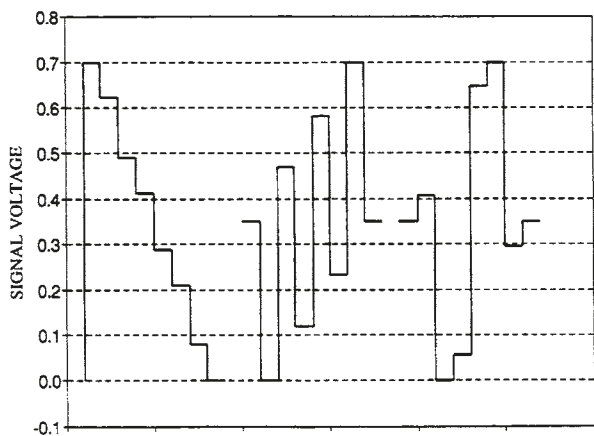

▶ **Figure A7.** A valid color-difference signal can be converted to a legal RGB signal.

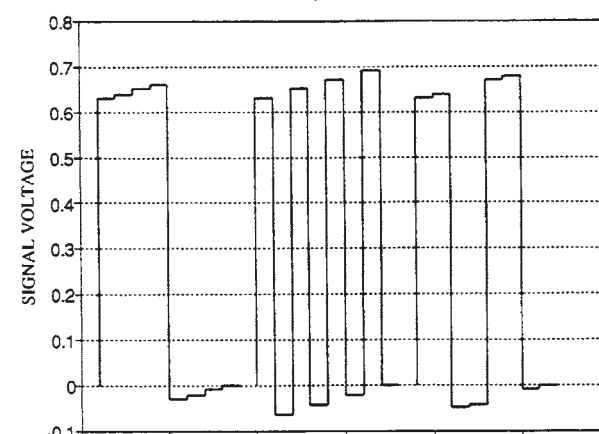
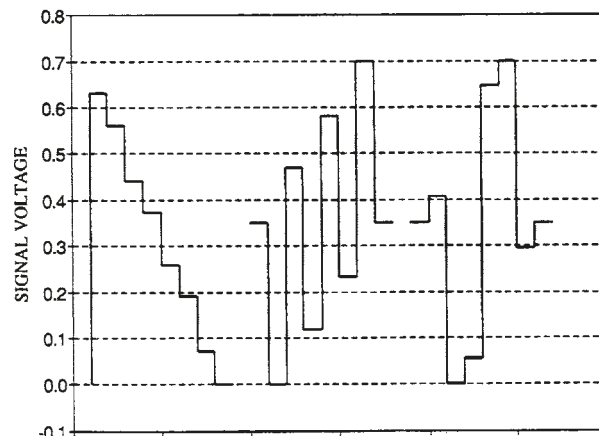

▶ **Figure A8.** An invalid signal, legal in one format but illegal when converted.

A valid signal is one that is within color gamut and remains legal when translated into any other format. A valid signal is always legal, but a legal signal is not necessarily valid. The latter case most often occurs with a color-difference format component signal, where the signal levels are not independent, as they are in RGB systems. Figures A7 and A8 show how a simple gain distortion in a color-difference component signal can make the signal invalid, though not illegal.

Figure A7 shows a legal and valid color-difference signal (top) and the legal RGB signal (bottom) to which it translates. In Figure A8, however, the luma

channel of the color-difference signal (top) is distorted; it has a relative gain of only 90 percent. When this distorted signal is transcoded to the RGB format (bottom), the result is an illegal signal – all three components extend below the minimum allowed signal level. Since the distorted color-difference signal cannot be translated into a legal RGB signal, it is invalid. Other forms of distortion can also create invalid signals.

Valid signals can be translated, encoded, or input to any part of a video system without causing amplitude-related problems.

### Format conversion tables

The following conversion tables show how translation between Y'P'bP'r values and G'B'R' products can be calculated. In Table A2, the values of 100% color bars are translated from G'B'R' into Y'P'bP'r. The dynamic range of R'G'B' (0 to 700 mV) is not exceeded and the conversion process results in signals that do not exceed the analog dynamic range of Y'P'bP'r (0 to 700 mV for the luma channel and ±350 mV for the color-difference channels). This signal is said to be Legal and Valid. A signal is Legal if it falls within the dynamic range of that format. A signal is Valid if it represents a color that is within the valid color gamut. Such a signal, when transcoded to R'G'B' will always produce an R'G'B' signal that is legal.

When a signal exceeds the dynamic range of a format, it becomes illegal. Table A3 shows signals which are legal in the Y'P'bP'r domain; however, when these values are converted to G'B'R', some of the values fall outside of the 0 to 700 mV threshold set for G'B'R' indicating that they are invalid and represent colors outside the valid gamut. Distortion of the signals could likely occur by processing equipment which is expected to only process the signal within the specified format range and may clip the signal if it exceeds these values. Tektronix has developed specific displays to assist operators and engineers in maintaining Legal and Valid signals.

Table A2. Legal and Valid G'B'R' Signal with Equivalent Legal and Valid Y'P'bP'r Signal

#### 100% Color Bars

Color	G' (mV)	B' (mV)	R' (mV)	Y' (mV)	P'b (mV)	P'r (mV)
White	700	700	700	700	0	0
Yellow	700	0	700	620.2	-350	56.7
Cyan	700	700	0	490.7	118.3	-350
Green	700	0	0	410.9	-231.7	-293.3
Magenta	0	700	700	289.1	231.7	293.3
Red	0	0	700	209.3	-118.3	350
Blue	0	700	0	79.8	350	-56.7
Black	0	0	0	0	0	0

Table A3. Legal but Invalid Y'P'bP'r Signals with Equivalent Illegal G'B'R' Signals

Y' (mV)	P'b (mV)	P'r (mV)	G' (mV)	B' (mV)	R' (mV)	Color
700	350	350	330	1320	1911	Illegal GBR
700	-350	-350	1070	80	160	Illegal GBR
700	0	350	450	700	1191	Illegal GBR
700	0	-350	950	700	160	Illegal GBR
700	350	0	580	1320	700	Illegal GBR
700	-350	0	820	80	700	Illegal GBR
700	0	0	700	700	700	White
0	350	350	-370	620	491	Illegal GBR
0	-350	-350	370	-620	491	Illegal GBR
0	0	350	-250	0	491	Illegal GBR
0	0	-350	250	0	-491	Illegal GBR
0	350	0	-120	620	0	Illegal GBR
0	-350	0	120	-620	0	Illegal GBR
0	0	0	0	0	0	Black

▶ Appendix B – Television Clock Relationships

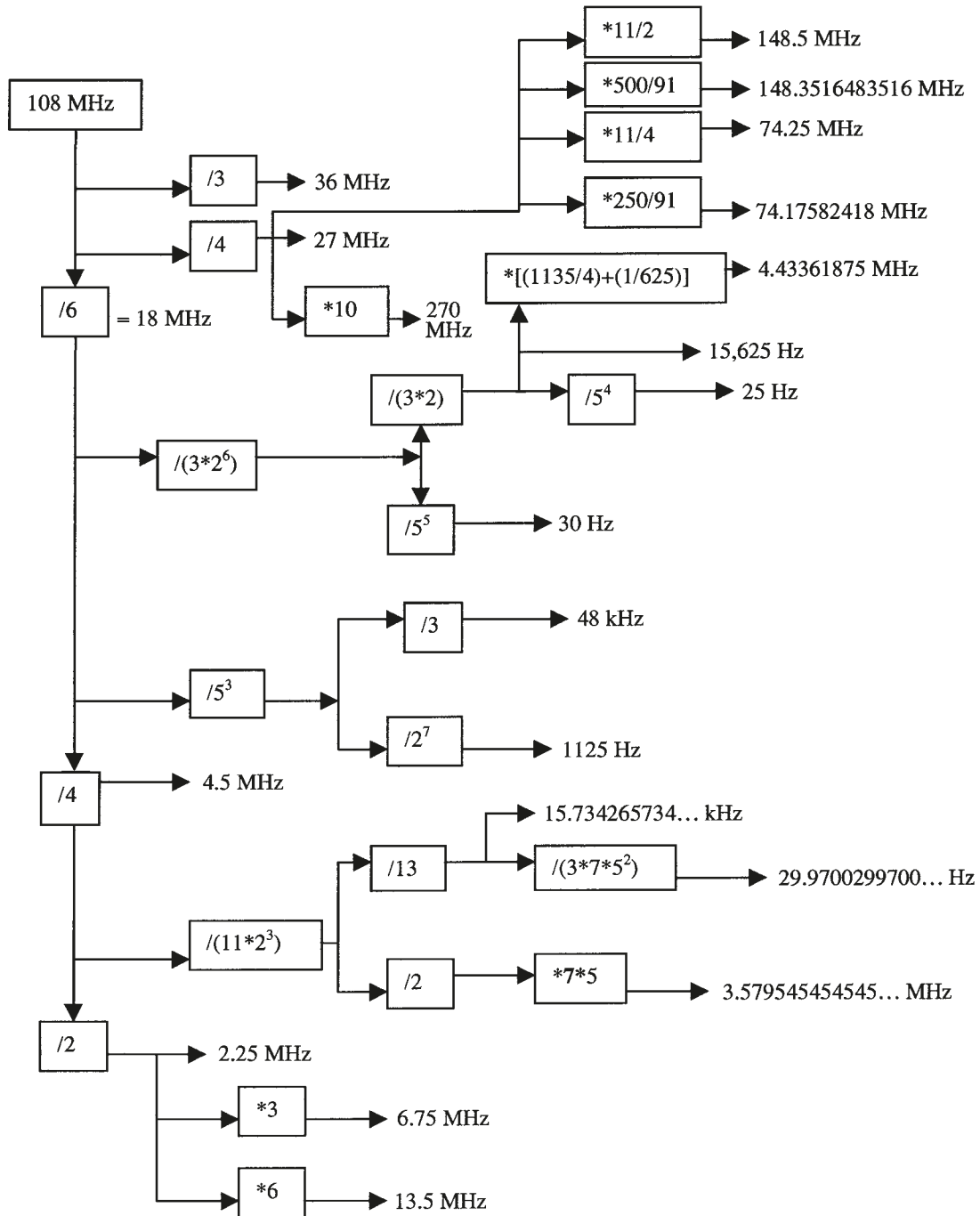

▶ **Figure B1.** Video clock derivations.



▶ Appendix C – Standard Definition Analog Composite Video Parameters

Table C1. Standard Definition Composite Video Parameters

	PAL B/G	NTSC	SECAM	PAL-M	PAL-N
Sync Type	negative bi-level	negative bi-level	negative bi-level	negative bi-level	negative bi-level
Subcarrier Freq. (MHz)	4.43361875	3.579545	4.406250 4.250000	3.57561149	3.58205625
Lines/Frame	625	525	625	525	625
Field Freq. (Hz)	50.00	59.94	50.00	59.94	50.00
Line Freq. (kHz)	15.625	15.734264	15.625	15.734264	15.625
Line Period (ms)	64.000	63.555	64.000	63.555	64.000
Line Blanking (ms)	12.05	10.90	12.05	10.90	12.05
Back Porch (ms)	10.50	9.40	10.50	9.40	10.50
Front Porch (ms)	1.55	1.50	1.55	1.50	1.55
Sync Width (ms)	4.7	4.7	4.7	4.7	4.7
Sync Amplitude (mV)	-300	-286	-300	-286	-300
Sync Amplitude (IRE)	-43	-40	-43	-40	-43
Sync Rise/Fall (ms)	0.200	0.250	0.200	0.250	0.200
Sync to Burst (ms)	5.6	5.3	-	5.8	5.6
Burst Duration (ms)	2.25 ±0.28	2.23 to 3.11	-	2.25 ±0.28	2.51 ±0.28
Burst Duration (Cycles of SC)	10 ±1	9 ±1	-	9 ±1	9 ±1
Burst Ampl. (mV)	300	286	166	286	300
Field Period (ms)	20	16.6833	20	16.6833	20
Field Blanking (lines)	25	21	25	21	25

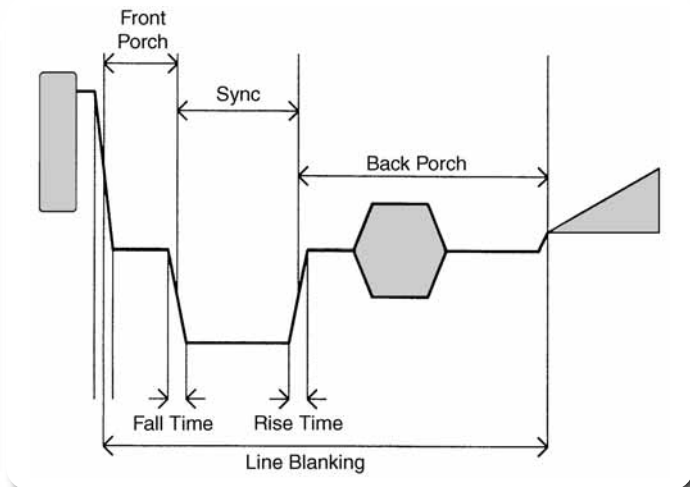

▶ Figure C1. PAL and NTSC system horizontal interval.

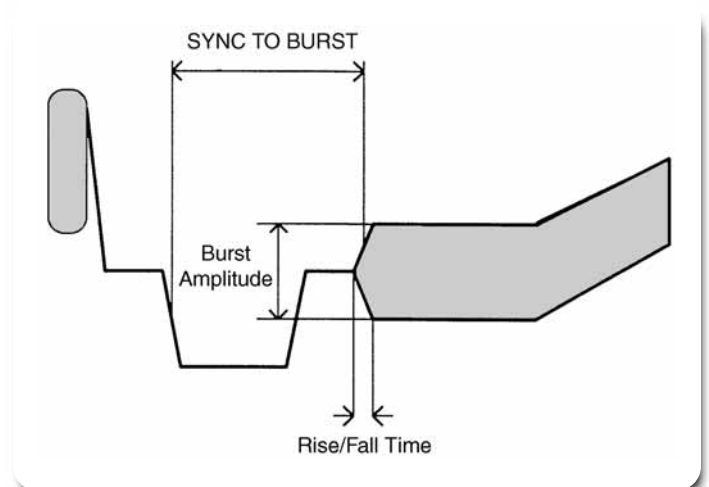

▶ Figure C2. SECAM system horizontal interval.

## ▶ Appendix D – Reference Standards and Practices for Television

**ANSI S4.40-1992, Digital Audio Engineering** - Serial Transmission Format for Two-Channel Linearly Represented Digital Audio Data (AES-3)

**ANSI/SMPTE 125M-1992, Television** - Component Video Signal 4:2:2 - Bit-Parallel Digital Interface

**ANSI/SMPTE 170M-1994, Television** - Composite Analog Video Signal - NTSC for Studio Applications

**ANSI/SMPTE 240M-1995, Television** - Signal Parameters - 1125-Line High-Definition Production Systems

**ANSI/SMPTE 259M-1993, Television** - 10-Bit 4:2:2 Component and 4fsc NTSC Composite Digital Signals - Serial Digital Interface

**SMPTE 260M-1992, Television** - Digital Representation and Bit-Parallel Interface - 1125/60 High Definition Production System

**ANSI/SMPTE 272M-1994, Television** - Formatting AES/EBU Audio and Auxiliary Data into Digital Video Ancillary Data Space

**ANSI/SMPTE 274M-1995, Television** - 1920 x 1080 Scanning and Analog and Parallel Digital Interfaces for Multiple Picture Rates

**ANSI/SMPTE 291M-1996, Television** - Ancillary Data Packet and Space Formatting

**ANSI/SMPTE 292M-1996, Television** - Bit-Serial Digital Interface for High-Definition Television Systems

**ANSI/SMPTE 293M-1996, Television** - 720 x 483 Active Line at 59.94-Hz Progressive Scan Production - Digital Representation

**ANSI/SMPTE 294M-1997, Television** - 720 x 483 Active Line at 59.94-Hz Progressive Scan Production - Bit-Serial Interfaces

**ANSI/SMPTE 295M-1997, Television** - 1920 x 1080 50 Hz - Scanning and Interface

**ANSI/SMPTE 296M-1997, Television** - 1280 x 720 Scanning, Analog and Digital Representation and Analog Interface

**ANSI/SMPTE 299M-1997, Television** - 24-Bit Digital Audio Format for HDTV Bit-Serial Interface

**ANSI/SMPTE 305M- 2000, Television** - Serial Data Transport Interface (SDTI)

**ANSI/SMPTE 310M- 2004, Television** - Synchronous Serial Interface for MPEG-2 Digital Transport Stream

**SMPTE 318M-1999** - Synchronization of 59.94 or 50 Hz Related Video and Audio Systems in Analog and Digital Areas - Reference Signals

**ANSI/SMPTE 320M- 1999, Television** - Channel Assignments and Levels on Multichannel Audio Media

**ANSI/SMPTE 346M- 2000, Television** - Time Division Multiplexing Video signals and Generic Data over High Definition Television Interfaces

**ANSI/SMPTE 347M- 2001, Television** - 540Mb/s Serial Digital Interface - Source Image Format Mapping

**ANSI/SMPTE 348M- 2000, Television** - High Data rate Serial Data Transport Interface (HD-SDTI)

**ANSI/SMPTE 349M- 2001, Television** - Transport of Alternate Source Image Formats through SMPTE292

**ANSI/SMPTE 352M- 2002, Television** - Video Payload Identification for Digital Television Interfaces

**ANSI/SMPTE 372M- 2002, Television** - Dual Link 292M Interface for 1920x1080 Picture Raster

**CIE Publication No 15.2, Colorimetry** - Second Edition (1986), Central Bureau of the Commission Internationale de L'Eclairage, Vienna, Austria.

**ITU-R BT.601-5** - Studio Encoding Parameters of Digital Television for Standard 4:3 and Wide-Screen 16:9 Aspect Ratios  
**ITU-R BT.656-4** - Interfaces for Digital Component Video Signals in 525-line and 625-line Television Systems Operating at the 4:2:2 Level of Recommendation ITU-R BT-601 (Part A)

**ITU-R BT.709-4-2000** - Parameter Values for the HDTV Standards for Production and International Programme Exchange  
**ITU-R BT.1120-2** - Digital Interfaces for 1125/60 and 1250/50 HDTV Studio Signals

**SMPTE Engineering Guideline EG33-1998** - Jitter characteristics and measurements

**SMPTE RP160-1997** - Three-Channel Parallel Analog Component High-Definition Video Interface

**SMPTE RP165-1994** - Error Detection Checkwords and Status Flags for Use in Bit-Serial Digital Interfaces for Television

**SMPTE RP168-1993** - Definition of Vertical Interval Switching Point for Synchronous Video Switching

**SMPTE RP177-1993** - Derivation of Basic Television Color Equations

**SMPTE RP178-1996** - Serial Digital Interface Checkfield for 10-Bit 4:2:2 Component and 4fsc Composite Digital Signals

**SMPTE RP184-1996** - Specification of Jitter in Bit-Serial Digital Interfaces

**SMPTE RP186-1995** - Video Index Information Coding for 525- and 625- Line Television Systems

**SMPTE RP187-1995** - Center, Aspect Ratio and Blanking of Video Images

**SMPTE RP192-1996** - Jitter Measurement Procedures in Bit-Serial Digital Interfaces

**SMPTE RP198-1998** - Bit-Serial Digital Checkfield for Use in High-Definition Interfaces

**SMPTE RP211-2000** - Implementation of 24P, 25P, and 30P Segmented Frames for 1920 x 1080 Production Format

**SMPTE RP218-2002** - Specification for Safe Area and Safe Title Areas for Television Systems

**SMPTE RP219-2002** - High Definition, Standard Definition Compatible Color Bar Signal

▶ Appendix E – Bibliography

Margaret Craig, **Television Measurements, NTSC Systems**, Tektronix, 1994

Margaret Craig, **Television Measurements, PAL Systems**, Tektronix, 1991

Keith Jack, **Video Demystified, A Handbook for the Digital Engineer**, HighText Interactive, 1996

David K. Fibush, **A Guide to Digital Television Systems and Measurements**, Tektronix 1997

David K. Fibush, Tektronix, **Video Testing in a DTV World**, SMPTE Journal, 2000

Earl F. Glynn, **efg's Computer Lab**, <http://www.efg2.com/Lab>

John Horn, **Solving the Component Puzzle**, Tektronix, 1997

Charles Poynton, **A Technical Introduction to Digital Video**, John Wiley & Sons, 1996

Charles Poynton, **Frequently Asked Questions about Color**, [www.inforamp.n/~poynton](http://www.inforamp.n/~poynton), 1999

Charles Poynton, **A Guided Tour of Color Space**, 1997

Charles Poynton, **YUV and Luminance considered harmful: A plea for precise terminology in video**, 2000

Guy Lewis, **Applied Technology, Color and the Diamond Display**, Broadcast Engineering, November 1994

Michael Robin, **Video Concepts**, Miranda Technologies, 1999

Michael Robin and Michel Poulin, **Digital Television Fundamentals, Design and Installation of Video and Audio Systems**, McGraw-Hill, 1997

Peter D. Symes, **Video Compression, Fundamental Compression Techniques and an Overview of the JPEG and MPEG Compression Systems**, McGraw-Hill, 1998

Jerry C. Whitaker, **Television Engineering Handbook, Featuring HDTV Systems**, Revised Edition by K. Blair Benson, McGraw-Hill, 1992

## ► Appendix F – Glossary

**4:2:2** – A commonly used term for a component digital video format. The details of the format are specified in the ITU-R BT.601 standard document.

The numerals 4:2:2 denote the ratio of the sampling frequencies of the single luminance channel to the two color-difference channels. For every four-luminance samples, there are two samples of each color-difference channel. See ITU-R BT.601.

**4fsc** – Four times subcarrier sampling rate used in composite digital systems. In NTSC, this is 14.3 MHz. In PAL, this is 17.7 MHz. Standard definition component sampling is 13.5 MHz for luma, 6.75 for chroma in both 535/60 and 625/50 format.

**AES/EBU audio** – Informal name for a digital audio standard established jointly by the Audio Engineering Society and European Broadcasting Union organizations.

**algorithm** – A set of rules or processes for solving a problem in a finite number of steps.

**aliasing** – Defects in the picture typically caused by insufficient sampling or poor filtering of digital video. Defects are typically seen as jaggies on diagonal lines and twinkling or brightening in picture detail.

**analog** – An adjective describing any signal that varies continuously as opposed to a digital signal that contains discrete levels representing the binary digits 0 and 1.

**ancillary data** – data supporting the video signal or program. Time multiplexed into the video signal during the horizontal and/or vertical blanking intervals. Ancillary data may be sent between the EAV and SAV packets in horizontal blanking and in larger blocks during vertical blanking. Ancillary data may include checksums, multi-channel digital audio, and other data.

**asynchronous** – A transmission procedure that is not synchronized by a clock. Digital video is not asynchronous because sampling clock information must be extracted from data signal transitions for decoding.

**A-to-D Converter (analog-to-digital)** – A circuit that uses digital sampling to convert an analog signal into a digital representation of that signal.

**bandwidth** – 1) The difference between the upper and lower limits of a frequency, often measured in megahertz (MHz). 2) The complete range of frequencies over which a circuit or electronic system can function with less than a 3 dB signal loss. 3) The information carrying capability of a particular television channel.

**baseline shift** – A form of low-frequency distortion resulting in a shift in the DC level of the signal.

**bit** – A binary representation of 1 or 0. One of the quantized levels of a pixel.

**bit parallel** – Byte-wise transmission of digital video down a multi-conductor cable where each pair of wires carries a single bit. This standard is covered under SMPTE 125M, EBU 3267-E and ITU-R BT.656.

**bit serial** – Bit-wise transmission of digital video down a single conductor such as coaxial cable. May also be sent through fiber optics. This standard is covered under ITU-R BT.656.

**bit slippage** – 1) Occurs when word framing is lost in a serial signal so the relative value of a bit is incorrect. This is generally reset at the next serial signal, TRS-ID for composite and EAV/SAV for component. 2) The erroneous reading of a serial bit stream when the recovered clock phase drifts enough to miss a bit. 3) A phenomenon which occurs in parallel digital data buses when one or more bits gets out of time in relation to the rest. The result is erroneous data. Differing cable lengths is the most common cause.

**bit stream** – A continuous series of bits transmitted on a line.

**BNC** – Abbreviation of “baby N connector.” A cable connector used extensively in television.

**brightness signal** – Same as the luminance signal (Y). This signal carries information about the amount of light at each point in the image.

**byte** – A complete set of quantized levels containing all of the bits. Bytes consisting of 8 to 10 bits per sample are typical.

**cable equalization** – The process of altering the frequency response of a video amplifier to compensate for high-frequency losses in coaxial cable.

**CCIR** – International Radio Consultative Committee (Comité Consultatif International en Radiodiffusion), an international standards committee, now replaced by International Telecommunication Union (ITU).

**CCIR-601** – See ITU-R BT.601.

**CCIR-656** – See ITU-R BT.656.

**channel coding** – Describes the way in which the “1”s and “0”s of the data stream are represented on the transmission path.

**chroma key** – The process of controlling the replacement of part of a video image with a second image. The control signal is developed from characteristics of the chrominance of a video signal.

**chrominance signal, chroma** – The modulated subcarrier sidebands in a composite video signal. Also used to describe the color-difference signals in a component system – that is, those carrying information about the hue (which color) and saturation (how much color) in a pixel.

**clock jitter** – Timing uncertainty of the data cell edges in a digital signal.

**clock recovery** – The reconstruction of timing information from incoming digital data.

**coaxial cable** – A transmission line with a concentric pair of signal carrying conductors. There's an inner conductor and an outer conductive metallic sheath. The sheath aids in preventing external radiation from affecting the signal on the inner conductor and minimizes signal radiation from the transmission line.

**coding** – Representing each level of a video signal as a number, usually in binary form.

**coefficients** – A number (often a constant) that expresses some property of a physical system in a quantitative way.

**color correction** – A process by which the coloring in a television image is altered or corrected electronically. Care must be taken to insure that the modified video does not exceed the limits of subsequent processing or transmission systems.

**color-difference signals** – Video signals which convey only color information: For example, unmodulated R-Y and B-Y, I and Q, U and V, Pr and Pb, etc.

**component video signals** – A set of signals, each of which represents a portion of the information needed to generate a full color image: For example: R, G, and B; Y, I, and Q; or Y, R-Y, and B-Y.

**component analog** – The unencoded output of a camera, video-tape recorder, etc., consisting of three primary color signals: green, blue, and red (GBR) that together convey all necessary picture information. In some component video formats, these three components have been translated into a luminance signal and two color-difference signals, for example, Y, B-Y, and R-Y.

**component digital** – A digital representation of a component analog signal set, most often Y'C'bC'r. The encoding parameters are specified

by ITU-R BT.601. For standard definition formats, the parallel interface is specified by ITU-R BT.656 and SMPTE 125M (1991).

**composite analog** – An encoded video signal, such as NTSC or PAL video, that includes horizontal and vertical synchronizing information.

**composite digital** – A digitally encoded video signal, such as NTSC or PAL video, that includes horizontal and vertical synchronizing information.

**contouring** – Video picture defect due to quantizing at too coarse a level.

**cross color** – Spurious signals resulting from high-frequency luminance information being interpreted as color information in decoding a composite signal. Typical examples are “rainbows” on venetian blinds, striped shirts, etc.

**cross luminance** – Spurious signals occurring in the Y channel as a result of composite chroma signals being interpreted as luminance, such as “dot crawl” or “busy edges” on colored areas.

**decoder** – A device used to recover the component signals from a composite (encoded) source. Decoders are used in displays and in various processing hardware where component signals are required from a composite source, such as composite chroma keying or color correction equipment. Also used to represent a device for extracting video from a compressed signal.

**delay** – The time required for a signal to pass through a device or conductor.

**demultiplexer (demux)** – A device used to separate two or more signals that were previously combined by a compatible multiplexer and transmitted over a single channel.

**deserializer** – A device that converts serial digital information to parallel.

**differential gain** – A change in chrominance amplitude of a video signal caused by a change in luminance level of the signal.

**differential phase** – A change in chrominance phase of a video signal caused by a change in luminance level of the signal.

**digital components** – Component signals in which the values for each pixel are represented by a set of numbers.

**digital word** – The number of bits treated as a single entity by the system.

**discrete** – Having an individual identity. An individual circuit component.

# A Guide to Standard and High-Definition Digital Video Measurements

## ► Primer

**dither** – Typically a random, low-level signal (oscillation) which may be added to an analog signal prior to sampling. Often consists of white noise of one quantizing level peak-to-peak amplitude.

**dither component encoding** – A slight expansion of the analog signal levels so that the signal comes in contact with more quantizing levels. The results are smoother transitions. This is done by adding white noise (which is at the amplitude of one quantizing level) to the analog signal prior to sampling.

**drift** – Gradual shift or change in the output over a period of time due to change or aging of circuit components. Change is often caused by thermal instability of components.

**D-to-A converter (digital-to-analog)** – A device that converts digital signals to analog signals.

**DVTR** – Abbreviation of digital videotape recorder.

**EAV** – End of active video in component digital systems. One of two (EAV and SAV) timing reference packets.

**EBU** – European Broadcasting Union. An organization of European broadcasters that, among other activities, produces technical statements and recommendations for the 625/50 line television system.

**EBU TECH.3267-E** – The EBU recommendation for the parallel interface of 625-line digital video signal. A revision of the earlier EBU Tech.3246-E, which in turn was derived from CCIR-601 (now ITU-R BT.601) and contributed to CCIR-656 (ITU-R BT.656) standards.

**EDH (error detection and handling)** – Proposed SMPTE RP 165 for recognizing inaccuracies in the serial digital signal. It may be incorporated into serial digital equipment and employ a simple LED error indicator.

**equalization (EQ)** – Process of altering the frequency response of a video amplifier to compensate for high-frequency losses in coaxial cable.

**embedded audio** – Digital audio is multiplexed onto a serial digital data stream at the time allocated for ancillary data.

**encoder** – A device used to form a single (composite) color signal from a set of component signals. An encoder is used whenever a composite output is required from a source (or recording) which is in component format. Also represents a device used for video compression.

**error concealment** – A technique used when error correction fails (see error correction). Erroneous data is replaced by data synthesized from surrounding pixels.

**error correction** – A scheme that adds overhead to the data to permit a certain level of errors to be detected and corrected.

**eye pattern** – An oscilloscope waveform view of overlaid highs and lows of the data signal. The changing data vs. the clock-synchronized sweep creates the look of an eye. The waveform is used to evaluate transport layer analog performance.

**field-time (linear) distortion** – An unwarranted change in video signal amplitude that occurs in a time frame of a vertical scan (i.e., 16.66 Ms at 60 Hz).

**format, interconnect** – The configuration of signals used for interconnection of equipment in a specified system. Different formats may use different signal composition, reference pulses, etc.

**format, scanning** – In analog and standard definition digital, the total number of lines and the field rate, i.e., 625/50. In digital high definition, the number of luma pixels, the number of active video lines, the field rate, and the number of fields per frame, i.e., 1280/720/59.94/2:1.

**format conversion** – The process of both encoding/decoding and resampling of digital rates.

**frequency modulation** – Modulation of a sinewave or “carrier” by varying its frequency in accordance with amplitude variations of the modulating signal.

**frequency response rolloff** – A distortion in a transmission system where the higher frequency components are not conveyed at their original full amplitude and create a possible loss of color saturation.

**gain** – Any increase or decrease in strength of an electrical signal. Gain may be expressed in decibels.

**gamma** – The transfer characteristic, input vs. output. In a television system, gamma correction is applied at the source to provide additional gain in dark areas so as to compensate for the CRT and human vision. Gamma correction at the source avoids enhancing noise at the destination and reduces the number of bits necessary to convey a satisfactory picture.

**gamut** – The range of colors allowed for a video signal. Valid color gamut is defined as all colors represented by all possible combinations of legal values of an R'G'B' signal. Signals in other formats may represent colors outside valid gamut but still remain within their legal limits. These signals, when transcoded to R'G'B', will fall outside legal limits for R'G'B'. This may lead to clipping, crosstalk, or other distortions.

**G'B'R', G'B'R' format** – The same signals as R'G'B'. The sequence is rearranged to indicate the mechanical sequence of the con-



nectors in the SMPTE standard. Often parade displays on waveform monitors will reflect this order.

**group delay** – A signal defect caused by different frequencies having differing propagation delays (delay at 1 MHz is different from delay at 5 MHz).

**horizontal interval (horizontal blanking, interval)** – The time period between lines of active video.

**interconnect format** – See format.

**interconnect standard** – See standard.

**interlace scanning** – A scanning format where the picture is captured and displayed in two fields. The second field is offset one-half line horizontally from the first field to present the lines of each field vertically interposed between the lines of the other.

**interpolation** – In digital video, the creation of new pixels in the image by some method of mathematically manipulating the values of neighboring pixels.

**invalid signal** – See valid signal.

**i/o** – Abbreviation of input/output. Typically refers to sending information or data signals to and from devices.

**ITU-R** – The International Telecommunication Union, Radio Communication Sector (replaces the CCIR).

**ITU-R BT.601** – An international standard for component digital television from which was derived SMPTE 125M (was RP-125) and EBU 3246E standards. ITU-R BT.601 defines the sampling systems, matrix values, and filter characteristics for both Y, B-Y, R-Y and GBR component digital television.

**ITU-R BT.656** – The physical parallel and serial interconnect scheme for ITU-R BT.601. ITU-R BT.656 defines the parallel connector pinouts as well as the blanking, sync, and multiplexing schemes used in both parallel and serial interfaces. Reflects definitions in EBU Tech 3267 (for 625-line signals) and in SMPTE 125M (parallel 525) and SMPTE 259M (serial 525).

**jaggies** – Slang for the stair-step aliasing that appears on diagonal lines. Caused by insufficient filtering, violation of the Nyquist Theory, and/or poor interpolation.

**jitter** – An undesirable random signal variation with respect to time.

**keying** – The process of replacing part of one television image with video from another image; i.e., chroma keying and insert keying.

**legal/illegal** – A signal is legal if it stays within the gamut appropriate for the format in use. A legal signal does not exceed the voltage limits specified for the format of any of the signal channel. An illegal signal is one that is sometimes outside those limits in one or more channels. A signal can be legal but still not be valid.

**luma, luminance (Y)** – The video signal that describes the amount of light in each pixel; equivalent to the signal provided by a monochrome camera, Y is often generated as a weighted sum of the R', G', and B' signals.

**MAC** – Multiplexed Analog Component video. This is a means of time multiplexing component analog video down a single transmission channel such as coax, fiber, or a satellite channel. Usually involves digital processes to achieve the time compression.

**microsecond ( $\mu\text{s}$ )** – One millionth of a second:  $1 \times 10^{-6}$  or 0.000001 second.

**monochrome signal** – A “single color” video signal – usually a black and white signal but sometimes the luminance portion of a composite or component color signal.

**MPEG** – Motion pictures expert group. An international group of industry experts set up to standardize compressed moving pictures and audio.

**multi-layer effects** – A generic term for a mix/effects system that allows multiple video images to be combined into a composite image.

**multiplexer (mux)** – Device for combining two or more electrical signals into a single, composite signal.

**nanosecond (ns)** – One billionth of a second:  $1 \times 10^{-9}$  or 0.000000001 second.

**neutral colors** – The range of gray levels, from black to white, but without color. For neutral areas in the image, the R'G'B' signals will all be equal; in color-difference formats, the color-difference signals will be zero.

**NICAM (near instantaneous companded audio multiplex)** – A digital audio coding system originally developed by the BBC for point-to-point links. A later development, NICAM 728 is used in several European countries to provide stereo digital audio to home television receivers.

**nonlinear encoding** – Relatively more levels of quantization are assigned to small amplitude signals, relatively fewer to the large signal peaks.

**nonlinearity** – Having gain vary as a function of signal amplitude.

# A Guide to Standard and High-Definition Digital Video Measurements

## ► Primer

**NRZ** – Non return to zero. A coding scheme that is polarity sensitive. 0 = logic low; 1 = logic high.

**NRZI** – Non return to zero inverse. A data coding system scheme that is polarity insensitive. 0 = no change in logic; 1 = a transition from one logic level to the other.

**NTSC (National Television Systems Committee)** – Organization that formulated standards for the NTSC television system. Now describes the American system of color telecasting which is used mainly in North America, Japan, and parts of South America.

**Nyquist sampling theorem** – Intervals between successive samples must be equal to or less than one-half the period of highest frequency.

**orthogonal sampling** – Sampling of a line of repetitive video signal in such a way that samples in each line are in the same horizontal position (co-timed).

**PAL (Phase Alternate Line)** – The name of the color television system in which the V component of burst is inverted in phase from one line to the next in order to minimize hue errors that may occur in color transmission.

**parallel cable** – A multi-conductor cable carrying parallel data.

**patch panel** – A manual method of routing signals using a panel of receptacles for sources and destinations and cables to inter-connect them.

**peak to peak** – The amplitude (voltage) difference between the most positive and the most negative excursions (peaks) of an electrical signal.

**phase distortion** – A picture defect caused by unequal delay (phase shifting) of different frequency components within the signal as they pass through different impedance elements – filters, amplifiers, ionospheric variations, etc. The defect in the picture is “fringing,” like diffraction rings, at edges where the contrast changes abruptly.

**phase error** – A picture defect caused by the incorrect relative timing of a signal in relation to another signal.

**phase shift** – The movement in relative timing of a signal in relation to another signal.

**pixel** – The smallest distinguishable and resolvable area in a digital video image. A single point on the screen. A single sample of the picture. Derived from the words picture element.

**PRBS** – Pseudo random binary sequence.

**primary colors** – Colors, usually three, that are combined to produce the full range of other colors within the limits of a system. All non-primary

colors are mixtures of two or more of the primary colors. In television, the primary colors are specific sets of red, green, and blue.

**production switcher (vision mixer)** – A device that allows transitions between different video pictures. Also allows keying and matting (compositing).

**progressive scanning** – A scanning format where the picture is captured in one top-to-bottom scan.

**propagation delay (path length)** – The time it takes for a signal to travel through a circuit, piece of equipment, or a length of cable.

**quantization** – The process of converting a continuous analog input into a set of discrete output levels.

**quantizing noise** – The noise (deviation of a signal from its original or correct value) which results from the quantization process. In serial digital, a granular type of noise only present in the presence of a signal.

**rate conversion** – 1) Technically, the process of converting from one sample rate to another. The digital sample rate for the component format is 13.5 MHz; for the composite format it's either 14.3 MHz for NTSC or 17.7 MHz for PAL. 2) Often used incorrectly to indicate both resampling of digital rates and encoding/decoding.

**Rec. 601** – See ITU-R BT.601.

**reclocking** – The process of clocking the data with a regenerated clock.

**resolution** – The number of bits (four, eight, ten, etc.) determines the resolution of the digital signal:

4-bits = A resolution of 1 in 16

8-bits = A resolution of 1 in 256

10-bits = A resolution of 1 in 1024

Eight bits is the minimum acceptable for broadcast TV. RP 125 – See SMPTE 125M.

**RGB, RGB format, RGB system** – The basic parallel component set (Red, Green, and Blue) in which a signal is used for each primary color. Also used to refer to the related equipment, interconnect format, or standards, The same signals may also be called “GBR” as a reminder of the mechanical sequence of connections in the SMPTE interconnect standard.

**rise time** – The time taken for a signal to make a transition from one state to another – usually measured between the 10% and 90% completion points on the transition. Shorter or “faster” rise times require more bandwidth in a transmission channel.

**routing switcher** – An electronic device that routes a user-supplied signal (audio, video, etc.) from any input to any user-selected output(s).

**sampling** – Process where analog signals are captured (sampled) for measurement.

**sampling frequency** – The number of discrete sample measurements made in a given period of time. Often expressed in Megahertz for video.

**SAV** – Start of active video in component digital systems. One of two (EAV and SAV) timing reference packets.

**scan conversion** – The process of resampling a video signal to convert its scanning format to a different format.

**scope** – Short for oscilloscope (waveform monitor) or vectorscope devices used to measure the television signal.

**scrambling** – 1) To transpose or invert digital data according to a pre-arranged scheme in order to break up the low-frequency patterns associated with serial digital signals. 2) The digital signal is shuffled to produce a better spectral distribution.

**segmented frames** – A scanning format in which the picture is captured as a frame in one scan, as in progressive formats, but transmitted even lines as one field then odd lines as the next field as in an interlaced format.

**serial digital** – Digital information that is transmitted in serial form. Often used informally to refer to serial digital television signals.

**serializer** – A device that converts parallel digital information to serial digital.

**SMPTE (Society of Motion Picture and Television Engineers)** – A professional organization that recommends standards for the television and film industries.

**SMPTE Format, SMPTE Standard** – In component television, these terms refer to the SMPTE standards for parallel component analog video inter-connection.

**standard, interconnect standard** – Voltage levels, etc., that describe the input/output requirements for a particular type of equipment.

Some standards have been established by professional groups or government bodies (such as SMPTE or EBU). Others are determined by equipment vendors and/or users.

**still store** – Device for storage of specific frames of video.

**synchronous** – A transmission procedure by which the bit and character stream are slaved to accurately synchronized clocks, both at the receiving and sending end. In serial digital video, the synchronous receiver sampling clock is extracted from incoming data signal transitions.

**sync word** – A synchronizing bit pattern, differentiated from the normal data bit patterns, used to identify reference points in the television signal; also to facilitate word framing in a serial receiver.

**telecine** – A device for converting motion picture film to a video signal.

**temporal aliasing** – A visual defect that occurs when the image being sampled moves too fast for the sampling rate. An example is a wagon wheel that appears to rotate backwards.

**time base corrector** – Device used to correct for time base errors and stabilize the timing of the video output from a tape machine.

**TDM (time division multiplex)** – The management of multiple signals on one channel by alternately sending portions of each signal and assigning each portion to particular blocks of time.

**time-multiplex** – In the case of digital video, a technique for sequentially interleaving data from the three video channels so they arrive to be decoded and used together. In component digital formats, the sequence might be Y, Cb, Y, Cr, Y, Cb, etc. In this case Y has twice the total data capacity (detail) as either of the color-difference channels. Ancillary data would be time-multiplexed into the data stream during non-video time.

**TRS** – Timing reference signals in composite digital systems (four words long). For component video, EAV and SAV provide the timing reference.

**TRS-1D (timing reference signal identification)** – A reference signal used to maintain timing in composite digital systems. It's four words long.

**truncation** – Deletion of lower significant bits on a digital system.

## A Guide to Standard and High-Definition Digital Video Measurements

### ► Primer

**valid signal** – A video signal where all colors represented lie within the valid color gamut. A valid signal will remain legal when translated to RGB or other formats. A valid signal is always legal, but a legal signal is not necessarily valid. Signals that are not valid will be processed without problems in their current format, but problems may be encountered if the signal is translated to a new format.

**valid/invalid** – A valid signal meets two constraints: It is legal in the current format, and it will remain legal when properly translated to any other color signal format.

**VTR (video tape recorder)** – A device which permits audio and video signals to be recorded on magnetic tape.

**waveform** – A graphical representation of the relationship between voltage or current and time.

**word** – See byte.

**Y, C1, C2** – A generalized set of CAV signals: Y is the luminance signal, C1 is the 1st color-difference signal, and C2 is the 2nd color-difference signal.

**Y', C'b, C'r** – A gamma corrected set of color-difference signals used in digital component formats.

**Y, I, Q** – The set of CAV signals specified in 1953 for the NTSC system: Y is the luminance signal, I is the 1st color-difference signal, and Q is the 2nd color-difference signal.

**Y, Pb, Pr** – A version of (Y R-Y B-Y) specified for the SMPTE analog component standard.

**Y, R-Y, B-Y** – The general set of CAV signals used in the PAL system as well as for some composite encoder and most composite decoders in NTSC systems. Y is the luminance signal, R-Y is the 1st color-difference signal, and B-Y is the 2nd color-difference signal.

**Y, U, V** – Luminance and color-difference components for PAL systems. Often imprecisely used in conversation as an alternative to Y', P'b, P'r.

## Acknowledgements

The authors wish to thank the following persons for their contributions to this booklet:

- ▶ David Fibush, Jeff Noah, Margaret Craig, Dan Baker, Ken Ainsworth, Lionel Durant, and all of the people at Tektronix who have put so much time and study into the art of good video.
- ▶ The standards committee members for their development of standards providing a clear direction for the industry.
- ▶ The engineers, authors, and publishers who provide an education for all of us.

## About the authors

Guy Lewis studied physics, mathematics, and communications at Baylor and Texas A&M Universities and has served as a television station chief engineer and television group director of engineering. He joined Tektronix in 1987 after 20 years with RCA in broadcast field engineering, sales management, and product line management. He retired from Tektronix in 1999, where he was Product Marketing Manager, TV Test, responsible for television waveform monitoring and baseband signal generation products.

Michael Waidson received a B.S. in communications from the University of Kent at Canterbury, U.K. He began his career with an electronics manufacturer of consumer television sets, working on advanced television receiver design in the digital video department. For the past 12 years, he has worked in the television broadcast industry in Europe and the U.S. He is currently an application engineer in Tektronix' Video Business Unit.

## Disclaimer

Throughout this booklet, we describe ways digital television could be done. Devices will improve, and clever engineers will invent new ways to do things better and more economically. The important thing is to comply with standards as they evolve in order to maintain a high degree of economical compatibility. Enjoy the transition!

This booklet is an interpretation of information from sources believed to be reliable. It is intended to provide a broad understanding of many different individually standardized formats. Neither Tektronix nor the authors guarantee the accuracy or completeness of the information and shall not be held responsible for any errors or omissions arising out of the use of this document. The reader is urged to consult industry standards organizations for specific information.

## Contact Tektronix:

ASEAN / Australasia (65) 6356 3900

Austria +41 52 675 3777

Balkan, Israel, South Africa and other ISE Countries +41 52 675 3777

Belgium 07 81 60166

Brazil & South America 55 (11) 3741-8360

Canada 1 (800) 661-5625

Central East Europe, Ukraine and the Baltics +41 52 675 3777

Central Europe & Greece +41 52 675 3777

Denmark +45 80 88 1401

Finland +41 52 675 3777

France & North Africa +33 (0) 1 69 86 81 81

Germany +49 (221) 94 77 400

Hong Kong (852) 2585-6688

India (91) 80-22275577

Italy +39 (02) 25086 1

Japan 81 (3) 6714-3010

Luxembourg +44 (0) 1344 392400

Mexico, Central America & Caribbean 52 (55) 56666-333

Middle East, Asia and North Africa +41 52 675 3777

The Netherlands 090 02 021797

Norway 800 16098

People's Republic of China 86 (10) 6235 1230

Poland +41 52 675 3777

Portugal 80 08 12370

Republic of Korea 82 (2) 528-5299

Russia & CIS 7 095 775 1064

South Africa +27 11 254 8360

Spain (+34) 901 988 054

Sweden 020 08 80371

Switzerland +41 52 675 3777

Taiwan 886 (2) 2722-9622

United Kingdom & Eire +44 (0) 1344 392400

USA 1 (800) 426-2200

For other areas contact Tektronix, Inc. at: 1 (503) 627-7111

Updated 5 January 2006



## For Further Information

Tektronix maintains a comprehensive, constantly expanding collection of application notes, technical briefs, and other resources to help engineers working on the cutting edge of technology.

Please visit our Web site at [www.tektronix.com](http://www.tektronix.com)

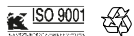

Copyright © 2005, Tektronix. All rights reserved. Tektronix products are covered by U.S. and foreign patents, issued and pending. Information in this publication supersedes that in all previously published material. Specification and price change privileges reserved. TEKTRONIX and TEK are registered trademarks of Tektronix, Inc. All other trade names referenced are the service marks, trademarks or registered trademarks of their respective companies.