

EECS150 - Digital Design

Lecture 16 - Memory

October 17, 2002
John Wawrzynek

Memory Basics

- Uses:
 - data & program storage
 - general purpose registers
 - buffering
 - table lookups
 - CL implementation
 - Whenever a large collection of state elements is required.
- Types:
 - RAM - random access memory
 - ROM - read only memory
 - EPROM, FLASH - electrically programmable read only memory

- Example RAM: Register file

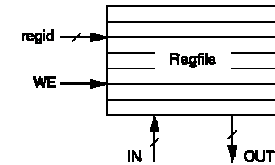

regid = register identifier
 $\text{sizeof}(\text{regid}) = \log_2(\# \text{ of reg})$
 WE = write enable

Definitions

Memory Interfaces for Accessing Data

- **Asynchronous (unclocked):**
A change in the address results in data appearing
- **Synchronous (clocked):**
A change in address, followed by an edge on CLK results in data appearing or write operation occurring.
- **Volatile:**
Loses its state when the power goes off.

Register File Internals

- Functionally the regfile is equivalent to a 2-D array of flip-flops:

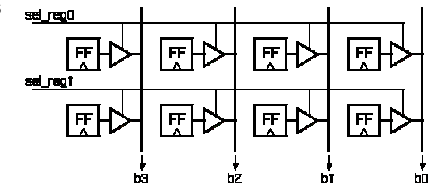

- Cell with write logic:

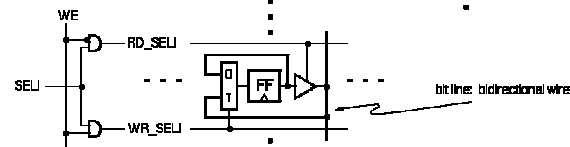

How do we go from "regid" to "SEL"?

Regid (address) Decoding

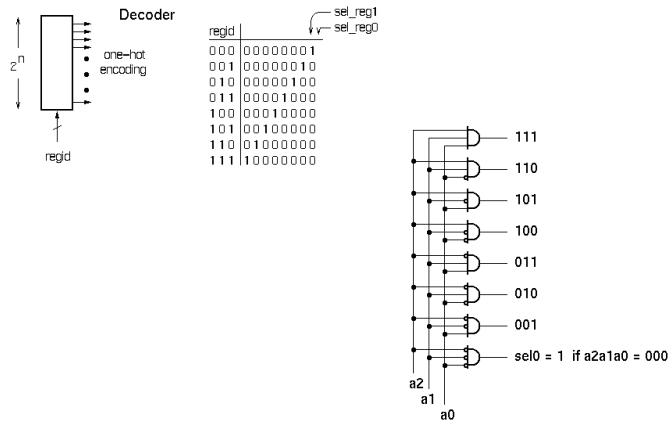

Fall 2002

EECS150 - Lec16-mem1

Page 5

Standard Internal Memory Organization

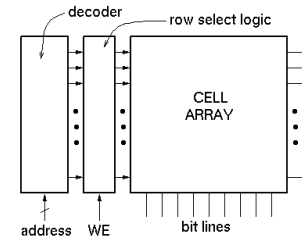

- Special circuit tricks are used for the cell array to improve storage density. (We will look at these later)

- RAM/ROM naming convention:

- examples: 32 X 8, "32 by 8" => 32 8-bit words
- 1M X 1, "1 meg by 1" => 1M 1-bit words

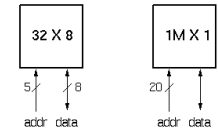

Fall 2002

EECS150 - Lec16-mem1

Page 6

Read Only Memory (ROM)

- Functional Equivalence:

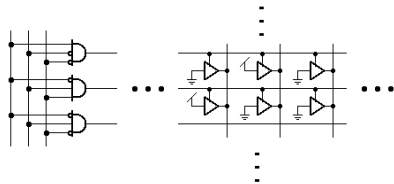

- Of course, full tri-state buffers are not needed at each cell point.
- Single transistors are used to implement zero cells. Logic one's are derived through *precharging* or bit-line *pullup transistor*.

Fall 2002

EECS150 - Lec16-mem1

Page 7

Column MUX in ROMs and RAMs:

- Controls physical aspect ratio
- In DRAM, allows reuse of chip address pins

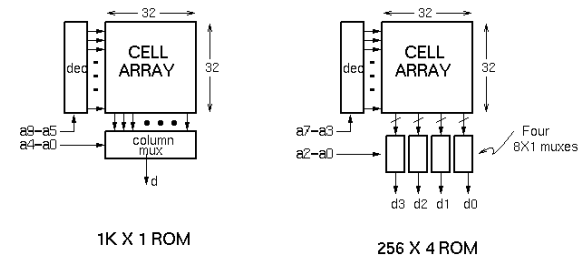

Fall 2002

EECS150 - Lec16-mem1

Page 8

Cascading Memory Modules (or chips)

- example 256 X 8 ROM using 256 X 4 parts:

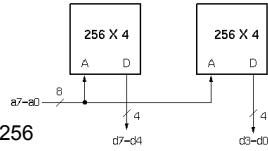

- example: 1K X * ROM using 256 X 4 parts:

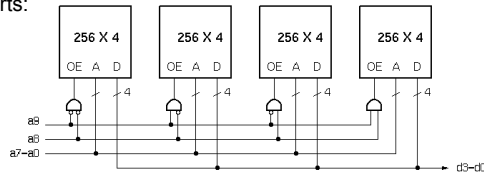

- each module has tri-state outputs:

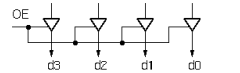

Fall 2002

EECS150 - Lec16-mem1

Page 9

Example Memory Components:

- Volatile:
 - Random Access Memory (RAM):
 - DRAM "dynamic"
 - SRAM "static"
- Non-volatile:
 - Read Only Memory (ROM):
 - Mask ROM "mask programmable"
 - EPROM "electrically programmable"
 - EEPROM "erasable electrically programmable"
 - FLASH memory - similar to EEPROM with programmer integrated on chip

Fall 2002

EECS150 - Lec16-mem1

Page 10

Volatile Memory Comparison

- SRAM Cell

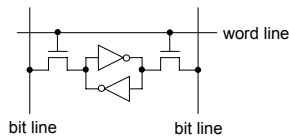

- DRAM Cell

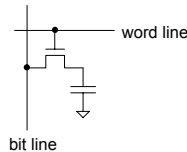

- Larger cell \Rightarrow lower density, higher cost/bit
- No refresh required
- Simple read \Rightarrow faster access
- Standard IC process \Rightarrow natural for integration with logic

- Smaller cell \Rightarrow higher density, lower cost/bit
- Needs periodic refresh, and refresh after read
- Complex read \Rightarrow longer access time
- Special IC process \Rightarrow difficult to integrate with logic circuits

Fall 2002

EECS150 - Lec16-mem1

Page 11

Multi-ported Memory

- Motivation:
 - Consider CPU core register file:
 - 1 read or write per cycle limits processor performance.
 - Complicates pipelining. Difficult for different instructions to simultaneously read or write regfile.
 - Common arrangement in pipelined CPUs is 2 read ports and 1 write port.

- Motivation:

- I/O data buffering:

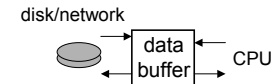

- dual-porting allows both sides to simultaneously access memory at full bandwidth.

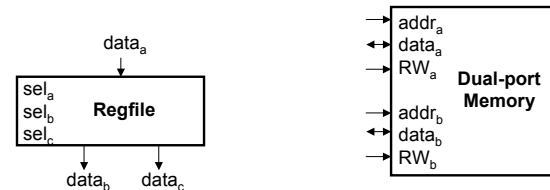

Fall 2002

EECS150 - Lec16-mem1

Page 12

Dual-ported Memory Internals

- Add decoder, another set of read/write logic, bits lines, word lines:

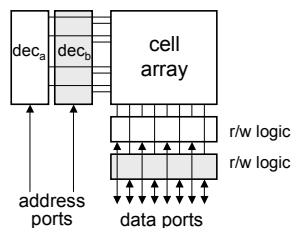

- Example cell: SRAM

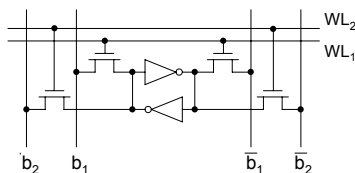

- Repeat everything but cross-coupled inverters.
- This scheme extends up to a couple more ports, then need to add additional transistors.

In Desktop Computer Systems:

- **SRAM** (lower density, higher speed) used in CPU register file, on- and off-chip caches.
- **DRAM** (higher density, lower speed) used in main memory

Processor-DRAM Gap (latency)

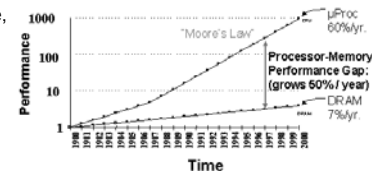

- Closing the GAP: Innovation targeted towards higher bandwidth for memory systems:
 - SDRAM - synchronous DRAM
 - RDRAM - Rambus DRAM
 - EDORAM - extended data out SRAM
 - Three-dimensional RAM
 - hyper-page mode DRAM video RAM
 - multibank DRAM

Important DRAM Examples:

- EDO - extended data out (similar to fast-page mode)
 - RAS cycle fetched rows of data from cell array blocks (long access time, around 100ns)
 - Subsequent CAS cycles quickly access data from row buffers if within an address page (page is around 256 Bytes)
- SDRAM - synchronous DRAM
 - clocked interface
 - uses dual banks internally. Start access in one bank then next, then receive data from first then second.
- DDR - Double data rate SDRAM
 - Uses both rising (positive edge) and falling (negative) edge of clock for data transfer. (typical 100MHz clock with 200 MHz transfer).
- RDRAM - Rambus DRAM
 - Entire data blocks are access and transferred out on a high-speed bus-like interface (500 MB/s, 1.6 GB/s)
 - Tricky system level design. More expensive memory chips.

Non-volatile Memory

Used to hold fixed code (ex. BIOS), tables of data (ex. FSM next state/output logic), slowly changing values (date/time on computer)

- Mask ROM
 - Used with logic circuits for tables etc.
 - Contents fixed at IC fab time (truly write once!)
- EPROM (erasable programmable) & FLASH
 - requires special IC process (floating gate technology)

Cell Operation: Programming

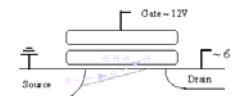

Figure 2 Cell bias conditions during programming

- writing is slower than RAM. EPROM uses special programming system to provide special voltages and timing.
- reading can be made fairly fast.
- rewriting is very slow.
 - erasure is first required, EPROM - UV light exposure

FLASH Memory

- Electrically erasable
- In system programmability and erasability (no special system or voltages needed)
- On-chip circuitry (FSM) to control erasure and programming (writing)
- Erasure happens in variable sized "sectors" in a flash (16K - 64K Bytes)

See: <http://developer.intel.com/design/flash/>
for product descriptions, etc.

Memory Specification in Verilog

- Memory modeled by an array of registers:

```
reg[15:0] memword[0:1023]; // 1,024 registers of 16 bits each

//Example Memory Block Specification
// Uses enable to control both write and read
//-----
//Read and write operations of memory.
//Memory size is 64 words of 4 bits each.
module memory (Enable,ReadWrite,Address,DataIn,DataOut);
    input Enable,ReadWrite;
    input [3:0] DataIn;
    input [5:0] Address;
    output [3:0] DataOut;
    reg [3:0] DataOut;
    reg [3:0] Mem [0:63]; //64 x 4 memory
    always @ (Enable or ReadWrite)
        if (Enable)
            if (ReadWrite)
                DataOut = Mem[Address]; //Read
            else
                Mem[Address] = DataIn; //Write
                else DataOut = 4'bz; //High impedance state
endmodule
```

Memory Blocks in FPGAs

- LUTs can double as small RAM blocks:
 - 4-LUT is really a 16x1 memory. Normally we think of the contents being written from the configuration bit stream, but Virtex architecture (and others) allow bits of LUT to be written and read from the general interconnect structure.
 - achieves 16x density advantage over using CLB flip-flops.
 - Furthermore, the two LUTs within a slice can be combined to create a 16 x 2-bit or 32 x 1-bit synchronous RAM, or a 16x1-bit dual-port synchronous RAM.
 - The Virtex-E LUT can also provide a 16-bit shift register of adjustable length.
- Newer FPGA families include larger on-chip RAM blocks (usually dual ported):
 - Called **block selectRAMs** in Xilinx Virtex series
 - 4k bits each

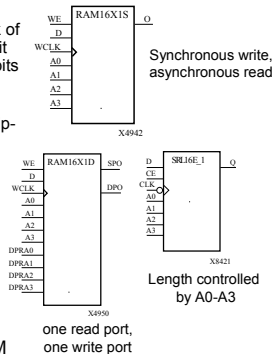

Verilog Specification for Virtex LUT RAM

```
module ram16x1(q, a, d, we, clk);
    output q;
    input d;
    input [3:0] a;
    input clk, we;
    reg mem [15:0];
    always @(posedge clk) begin
        if (we)
            mem[a] <= d;
    end
    assign q = mem[a];
endmodule
```

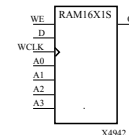

- Deeper and/or wider RAMs can be specified and the synthesis tool will do the job of wiring together multiple LUTs.
- How does the synthesis tool choose to implement your RAM as a collection of LUTs or as block RAMs?

Virtex "Block RAMs"

- Each block SelectRAM (block RAM) cell is a fully synchronous (synchronous write *and* read) dual-ported (true dual port) 4096-bit RAM with independent control signals for each port. The data widths of the two ports can be configured independently, providing built-in bus-width conversion.
- CLKA and CLKB can be independent, providing a nice way to "cross clock boundaries".
- Around 160 of these on the 2000E. Multiples can be combined to implement, wider or deeper memories.
- See chapter 8 of Synplify reference manual on how to write Verilog for implied Block RAMs. Or instead, explicitly instantiate as primitive (project checkpoint 2 will use this method).

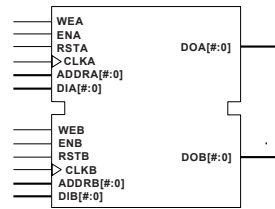
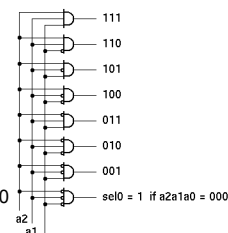

Table 5: Block SelectRAM Port Aspect Ratios

Width	Depth	ADDR Bus	Data Bus
1	4096	ADDR<11:0>	DATA<0>
2	2048	ADDR<10:0>	DATA<1:0>
4	1024	ADDR<9:0>	DATA<3:0>
8	512	ADDR<8:0>	DATA<7:0>
16	256	ADDR<7:0>	DATA<15:0>

Relationship between Memory and CL

- Memory blocks can be (and often are) used to implement combinational logic functions:
- Examples:
 - LUTs in FPGAs
 - 1Mbit x 8 EPROM can implement 8 independent functions each of $\log_2(1M)=20$ inputs.
- The *decoder part* of a memory block can be considered a "minterm generator".
- The *cell array part* of a memory block can be considered an OR function over a subset of rows.



- The combination gives us a way to implement logic functions directly in sum of products form.
- Several variations on this theme exist in a set of devices called Programmable logic devices (PLDs)

A ROM as AND/OR Logic Device

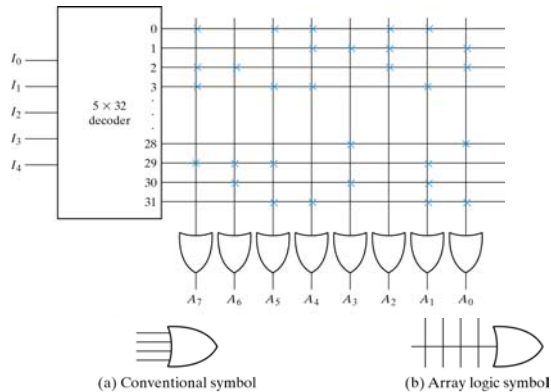

Fig. 7-1 Conventional and Array Logic Diagrams for OR Gate

PLD Summary

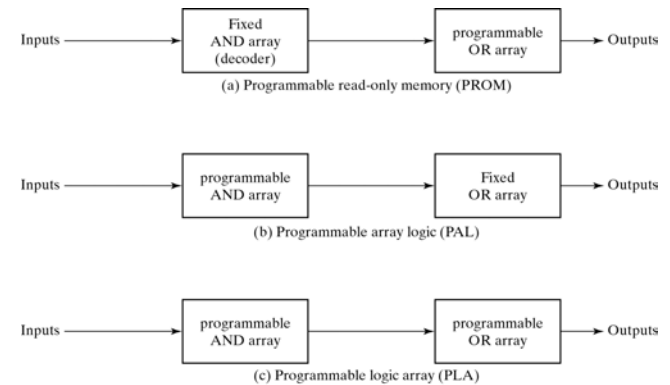

Fig. 7-13 Basic Configuration of Three PLDs

PLA Example

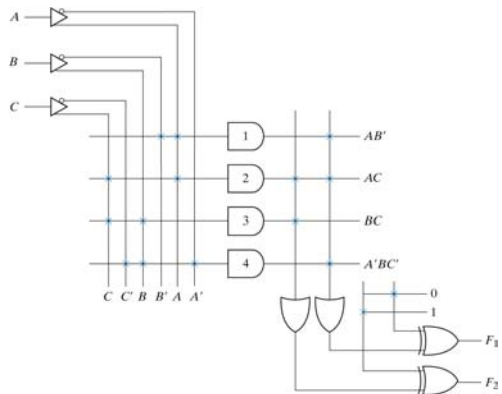

Fig. 7-14 PLA with 3 Inputs, 4 Product Terms, and 2 Outputs

PAL Example

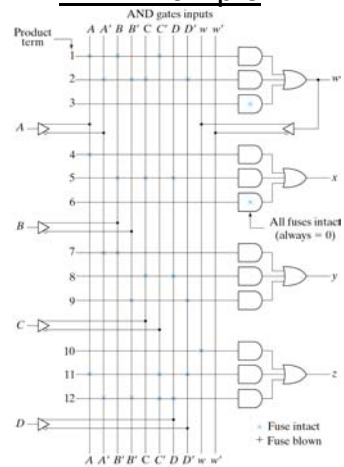

Fig. 7-17 Fuse Map for PAL as Specified in Table 7-6